



## 3801-T90 90"x42" Rectangular Dining Table Assembly Instructions

**IMPORTANT : PLEASE READ COMPLETE INSTRUCTION SHEET PRIOR TO ASSEMBLY!**  
 Identify all parts packed in carton against the parts list. Remove all protective materials, place parts on a nonabrasive surface to avoid scratching. If any parts are missing or damaged, DO NOT attempt to assemble.





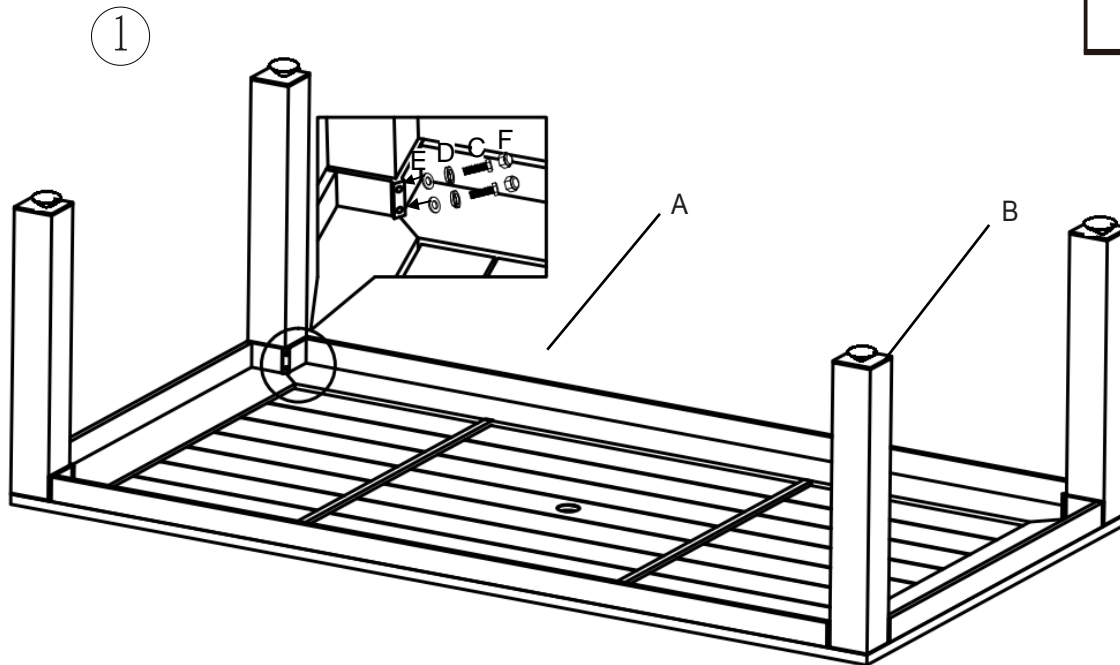

**Step 1:** Place table top upside down on a flat, soft surface.

Attach legs with supplied bolts and lock washers and metal washers.

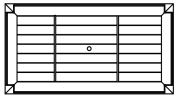
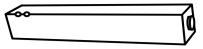
**Step 2:** Tighten all bolts. Cover all bolts with plastic bolt caps.

Turn the table in the upright position. Your table is now ready for use.

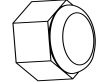

PARTS LIST			
A	TABLE TOP		1
B	TABLE LEG		4
C	BOLT(M8*35)		8
D	LOCK WASHER		8
E	METAL WASHER		8
F	PLASTIC BOLT CAP		8
G	HEX WRENCH		1

