



Coffee Table Assembly Instructions





IMPORTANT : PLEASE READ COMPLETE INSTRUCTION SHEET PRIOR TO ASSEMBLY!
 Identify all parts packed in carton against the parts list. Remove all protective materials, place parts on a nonabrasive surface to avoid scratching. If any parts are missing or damaged, DO NOT attempt to assemble.

Step 1: Place table top upside down on a flat, soft surface.

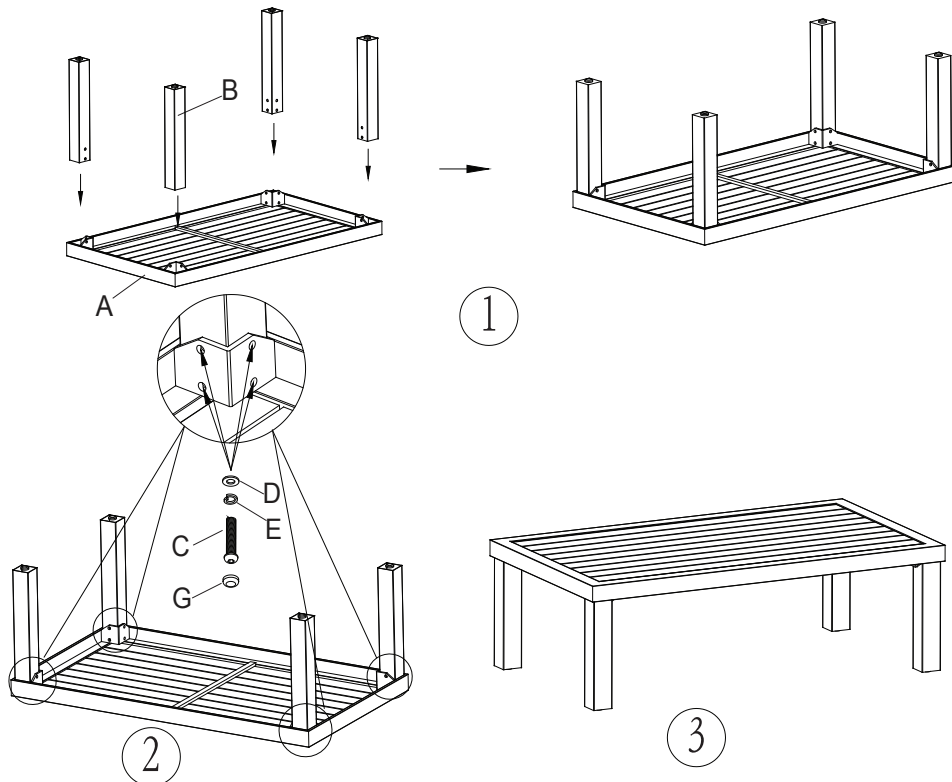
Step 2: Attach legs with supplied bolts and lock washers and metal washers.

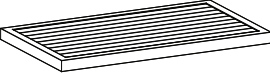
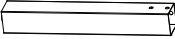
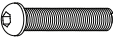
Step 3: Tighten all bolts. Cover all bolts with plastic bolt caps.
 Turn the table in the upright position. Your table is now ready for use.



PARTS LIST			
A	TABLE TOP		1
B	TABLE LEG		4
C	BOLT		16
D	METAL WASHER		16
E	LOCK WASHER		16
F	ALLEN WRENCH		1
G	PLASTIC BOLT CAP		16