









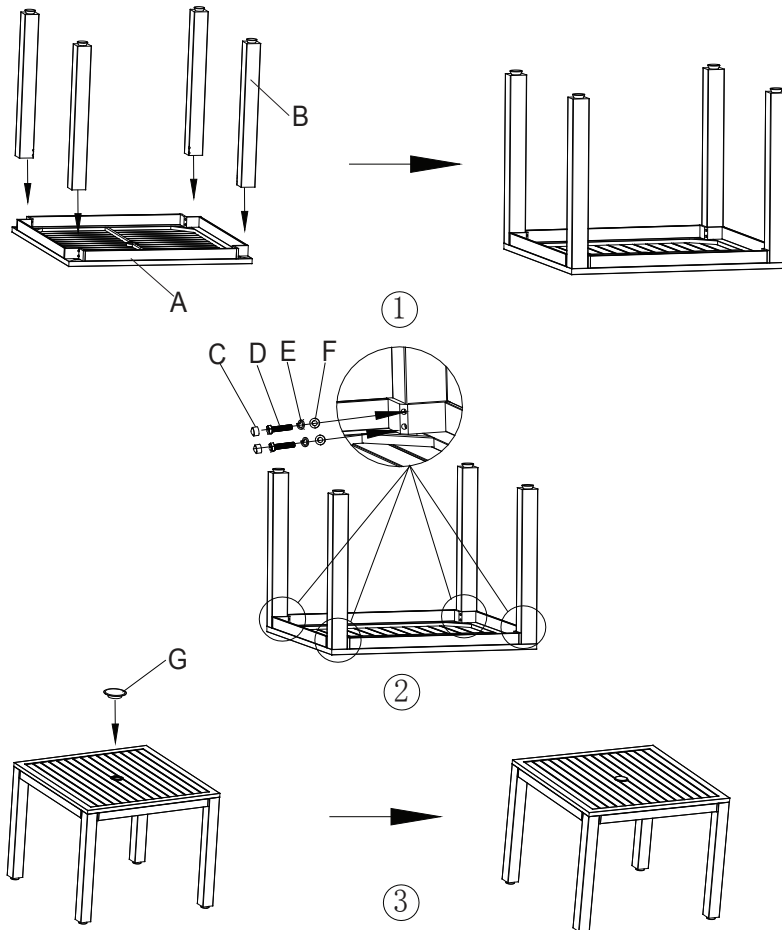

1102-SQT36 Vegas 36"X36" Square Dining Table Assembly Instructions

IMPORTANT : PLEASE READ COMPLETE INSTRUCTION SHEET PRIOR TO ASSEMBLY!
 Identify all parts packed in carton against the parts list. Remove all protective materials, place parts on a nonabrasive surface to avoid scratching. If any parts are missing or damaged, DO NOT attempt to assemble.

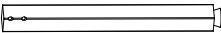
Step 1: Place table top upside down on a flat, soft surface.
 Attach legs with supplied bolts and lock washers and metal washers.

Step 2: Tighten all bolts. Cover all bolts with plastic bolt caps.
 Turn the table in the upright position. Your table is now ready for use.

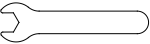

| PARTS LIST | | | |
|------------|----------------------|---|---|
| A | TABLE TOP |  | 1 |
| B | TABLE LEG |  | 4 |
| C | PLASTIC BOLT CAP(M8) |  | 8 |
| D | BOLT(M8*35) |  | 8 |
| E | LOCK WASHER (M8) |  | 8 |
| F | METAL WASHER(M8) |  | 1 |
| G | UMBRELLA COVER |  | 1 |
| H | ALLEN WRENCH |  | 1 |
| I | HEX WRENCH |  | 1 |