









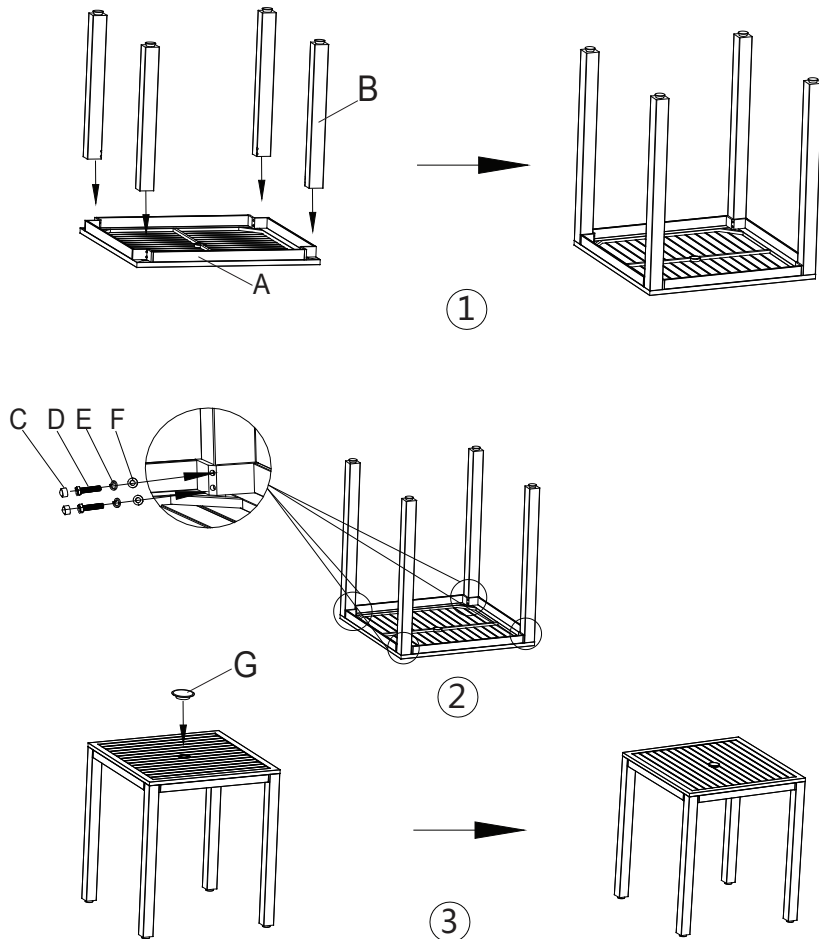

1201-P36 Vegas 36"X36" Square Bar Table Assembly Instructions

IMPORTANT : PLEASE READ COMPLETE INSTRUCTION SHEET PRIOR TO ASSEMBLY!
 Identify all parts packed in carton against the parts list. Remove all protective materials, place parts on a nonabrasive surface to avoid scratching. If any parts are missing or damaged, DO NOT attempt to assemble.

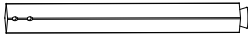
Step 1: Place table top upside down on a flat, soft surface.
 Attach legs with supplied bolts and lock washers and metal washers.

Step 2: Tighten all bolts. Cover all bolts with plastic bolt caps.
 Turn the table in the upright position. Your table is now ready for use.

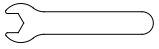

PARTS LIST			
A	TABLE TOP		1
B	TABLE LEG		4
C	PLASTIC BOLT CAP(M8)		8
D	BOLT(M8*35)		8
E	METAL WASHER(M8)		8
F	METAL WASHER(M8)		8
G	UMBRELLA COVER		1
H	ALLEN WRENCH		1
I	HEX WRENCH		1