



BUILT-IN ELECTRIC WALL OVEN

SEW24SSX

IMPORTANT SAFETY INSTRUCTIONS

Read these instructions completely and carefully. Save these instructions for the local inspector's use. Observe all governing codes and ordinances.

NOTE TO INSTALLER: Be sure to leave these instructions with the customer. Keep these instructions for future reference. Product failure due to improper installation is not covered under the warranty agreement.

INSTALLATION & USER MANUAL

Write Serial Number here:

Felix Storch, Inc.
ISO 9001:2015 registered company
770 Garrison Avenue
Bronx, NY 10474
www.summitappliance.com

Table of Contents

SAFETY AND WARNINGS	4-7
INSTALLING OVEN INTO KITCHEN	8
CONTROL PANEL DESCRIPTION	9
OPERATION INSTRUCTIONS	10
CLOCK SETTINGS	10
FUNCTION SETTINGS	10-11
LIGHTBULB SETTING	12
INQUIRY FUNCTION	12
CHILD LOCK FUNCTION	13
TIMER FUNCTION	13
TIMED COOKING FUNCTION	14
STARTING/PAUSING/CANCELING FUNCTIONS	14
ENERGY-SAVING FUNCTION	15
OPERATION NOTES	15
ACCESSORIES	16
SHELF PLACEMENT WARNING	17
LIGHTBULB REPLACEMENT	18
SECURING THE OVEN TO THE CABINET	19
VENTILATION OPENINGS	20
ELECTRICAL CONNECTION	21-23
OVEN INSTALLATION	24
REMOVING THE OVEN DOOR	25
CLEANING AND MAINTENANCE	26
WARRANTY & SERVICE	28-29

Safety & Warnings

WARNINGS

These are the most critical warnings summarized below.

WARNING

- Make sure the appliance is properly installed and grounded by a qualified technician.
- When the oven is first switched on, it may give off an unpleasant smell. This is due to the bonding agent used for the insulating panels within the oven. Please operate the appliance, completely empty, with the conventional cooking function at 500 degrees Fahrenheit for 90 minutes to burn away any residue inside the cavity.
- During the first use, there might be some smoke and a slight odor. If this occurs, wait for the smell to clear before using the oven.
- Please use the product in an open environment.
- Do not leave children unattended in area when the appliance is in use. Do not allow children to sit or stand on the appliance.
- If there is damage to or cracks in the glass of the oven door, switch off the appliance and do not operate until repairs have been completed.
- **DO NOT attempt to repair or replace any part of the appliance, unless specifically recommended in the manual. All other servicing should be done by a qualified technician.**
- During use, the appliance becomes very hot. Use caution and avoid touching heating elements inside the oven.

Safety & Warnings

- Do not allow children to go near the oven when it is operating.
- Children should be supervised to ensure that they do not use or play with the appliance.
- **All wiring and electrical connections should be installed to local code.** Some districts may require a licensed electrician to perform the installation of this appliance.
- Ensure that the appliance is off before replacing the oven lamp to avoid electric shock.
- Keep oven vent ducts unobstructed.
- Never use your appliance for warming or heating a room.
- Wear proper apparel while operating the appliance; loose-fitting or hanging garments should never be worn while using the appliance.
- Accessible parts may become hot during use.
- Use only dry potholders; moist or damp potholders on hot surfaces may result in burns from steam. DO NOT let the potholder touch hot heating elements. DO NOT use a towel or other bulky cloth.
- If the supply cord is damaged, the manufacturer, service agent, or similarly qualified technician must replace it to avoid a hazard.

Safety & Warnings

- DO NOT use harsh abrasive cleaners or sharp metal scrapers to clean the oven door glass; such cleaners and tools can scratch the surface, which may result in shattering of the glass.
- DO NOT use a steam cleaner to clean the appliance.
- The appliance is not designed to be operated by an external timer or separate remote-control system.
- The instructions for ovens that have shelves include details of the correct installations of the shelves.
- Use caution when opening oven door; let hot air or steam escape before removing or replacing food.
- Always place oven racks in desired location while oven is cool. If rack must be moved while oven is hot, do not let the potholder make contact with the hot heating element in oven.
- DO NOT heat unopened food containers, as the buildup of pressure may cause the container to burst and result in injury.
- **DO NOT TOUCH HEATING ELEMENTS OR INTERIOR SURFACES OF OVEN.** Heating elements may be hot even though they are dark in color. Interior surfaces of an oven can become hot enough to cause burns.
- **During and after use, DO NOT touch, or let clothing or other flammable materials contact heating elements or interior surfaces of oven, until they have had sufficient time to cool. Other surfaces of the appliance may become hot enough to cause burns, among these surfaces are oven vent openings and surfaces near these openings, oven doors, and over door windows.**

Safety & Warnings

- Flammable materials should NOT be stored in an oven or near surface units.
- **DO NOT USE WATER ON GREASE FIRES. Smother fire or flame or use dry chemical or foam-type fire extinguisher.**
- Kitchens are an active work environment, and as such, **we recommend wearing appropriate attire, including closed-toe shoes**, when operating this appliance.
- DO NOT touch the oven with wet or damp hands or feet.
- Do not open the oven door often while the unit is in use.
- **An authorized technician MUST install the appliance. The manufacturer is NOT responsible for any damage that might be caused by defective placement or installation by unauthorized personnel.**
- When the oven door or oven drawer is open, DO NOT leave any item on it; the appliance may become imbalanced, or the weight of the item will break the door.
- Some parts of the appliance may stay hot for a long time; allow the appliance to cool down completely and use extreme caution before touching any part of the appliance that is exposed to direct heat.
- If you will not use the appliance for a long time, it is advised to unplug the appliance.

Installing Oven into Kitchen

The oven can be installed underneath a work top or into an upright cupboard. Affix the oven into position by screwing it into place, using the two screw holes in the frame. To locate the screw holes, open the oven door and look inside. To allow adequate ventilation, the measurements and distances must be adhered to when fixing the oven.

IMPORTANT

To ensure the oven will function properly, the kitchen housing / panels of the kitchen cabinet next to the oven must be made of a heat-resistant material.

Ensure that the glue of cabinets made of veneered wood can withstand temperatures of at least 250 °F. Plastics or glues that cannot withstand such temperatures will melt and deform the cabinet, once the oven has been lodged inside the cabinets, electrical parts must be completely insulated. This is a legal safety requirement. All guards must be firmly fixed into place so that it is impossible to remove them without using special tools.

Remove the back of the kitchen cabinet to ensure an adequate current of air circulates the oven. The hob must have a rear gap of at least 45 mm.

When the oven is unpacked, check if the cabinet is damaged in any way. *If you have any doubts at all, DO NOT use it: contact a qualified professional.* Keep packing materials such as plastic bags, polystyrene, or nails out of the reach of children.

Control Panel Description

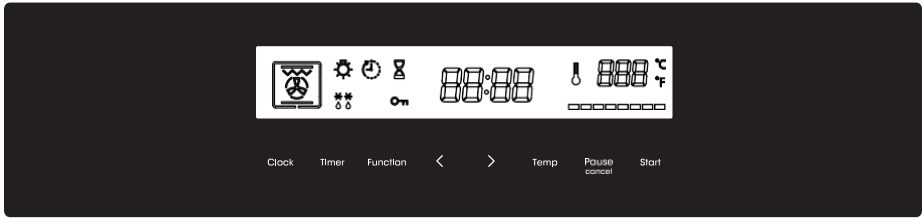

Symbol	Function Description
	Oven Lamp: Allows the user to observe the food inside of the oven, through the window. Oven lamp will light for all cooking functions.
	Defrost: The circulation of air at room temperature allows for quicker thawing of frozen food, without the use of any heat. A gentle but quick way to speed up the defrosting and thawing times of frozen foods, ready-made dishes, etc.
	Bottom Heater: A concealed element located on the bottom of the oven that provides heat. It is used for keeping food warm. The temperature can be set within the range of 150-500°F. The default temperature is 350°F.
	Conventional Cooking: Uses the top and bottom heating elements to provide convectional cooking. The temperature can be set within the range of 150-500°F. The default temperature is 350°F.
	Convention with Fan: Combination of the fan and each heating element provides more even heat distribution, saving up to 30-40% of energy. Dishes are lightly browned on the outside and still moist on the inside. NOTE: This function is suitable for grilling or roasting big pieces of meat at a higher temperature. The temperature can be set within the range of 150-500°F. The default temperature is 350°F.
	Double Grilling: For use with inner radiant grill element and top element. The temperature can be set within the range of 350-500°F. The default temperature is 350°F.
	Double Grilling with Fan: For use of the inner radiant grill element, top heating element and fan. The temperature can be set within the range of 350-500°F. The default temperature is 350°F.
	True Convection: An element around the fan provides an additional source of heat for convection-style cooking. In convection mode, the fan automatically comes on to improve air circulation within the oven and creates an even heat for cooking. The temperature can be set within the range of 150-500°F. The default temperature is 350°F.
	Radiant Grilling: The inner grill element switches on and off to maintain temperature. The temperature can be set within the range of 350-500°F. The default temperature is 350°F.

Operation Instructions

Clock Settings

After connecting the unit to the power, the numbers "12:00" will show on the display.

- 1.) Press "Clock", the hour number will flash.
- 2.) Press "<>" to adjust the hour number; time should be within numbers 0 through 12.
- 3.) Press "Clock", the minute number will flash.
- 4.) Press "<>" to adjust the minute number; time should be within numbers 0 through 59.
- 5.) Press "Clock" to finish the clock settings; symbol ":" flashes, and the time will be illuminated.

NOTE: This is a 12-hour clock. After oven is powered on, if the clock is not set, it will show "12:00" on display.

Function Settings

- 1.) Press "Function" to choose a cooking function. The related function indicator will light up. Continue pressing until desired function is selected.
- 2.) Press "<>" to adjust the cooking time and adjust the temperature before pressing "Temp" to switch.
- 3.) Press "Start" to begin cooking.

NOTE: If you skip Step 2, press "Start" to confirm the start of cooking; the default time is 9 hours, default temperature will be displayed on the LCD.

Operation Instructions



Function Settings

- After connecting the unit to the power, the numbers "12:00" will flash on the display.

- When adjusting the clock time or the timer, the increments will change after 30 minutes:

0--0:30 min: increases by 1 minute

0:30--9:00 hours: increases by 5 minutes

- The increments when adjusting the unit's temperature is 5 degrees. "  ". "  " cannot adjust the temperature.

- Press " < > " to adjust the cooking time when starting to cook. Then press " Start " to confirm. If " Start " not pressed within 6 seconds, the oven will revert to the previously selected time to continue cooking.

Press " Temp ", "  " shows, then press " < > " to adjust the temperature when starting to cook. Press " **Start** " to start cooking. If " **Start** " not pressed within 6 seconds, the oven will revert to the previously selected time to continue cooking.

Operation Instructions

Lightbulb Setting

- 1.) Press " Function " to select a function, and the corresponding icon will light up.
- 2.) Press " Start " button to start, " 0:00 " and icon "  " will light up, " : " will start blinking.

Inquiry Function

During the following functions, you can use the inquiry function; after 3 seconds, the inquiring function will turn off.

- 1.) While cooking, if the time clock was set, press " Clock " button to see the current time; if the timer function was set, press " Timer " button to see the remaining time.
- 2.) If a timer is set, if the clock was set, press " Clock " button to see the current time.
- 3.) If the time clock is showing but a timer has been set, press " Timer " to see the time remaining on the timer.

Operation Instructions

Child Lock Function



To Lock: Press " Start " and " ^{Pause}_{cancel} " simultaneously for 3 seconds, there will be a long beeping sound and the "  " symbol will light up.

To Unlock: Press " Start " and " ^{Pause}_{cancel} " simultaneously for 3 seconds, there will be a long beeping sound indicating the Child Lock has been unlocked.

NOTE: If you want to stop cooking, press the Stop button once (Do not hold the button down).

Timer Function

The oven comes with a timer function that can be set up to run up to 9 hours. The timer can only be set when the oven is in Standby Mode. To set the timer:

- 1.) Press the "Timer " button and the display will show "  " and "AL".
- 2.) Press "< > " to set the timer.
- 3.) Press "Start" to confirm settings. ":" will flash and the "  " icon will light up. The time will begin to count down.

NOTE: The oven buzzer will ring 10 times after the timer hits zero. Then the "  " symbol will disappear from the screen to alert you the timer has elapsed. You can cancel the timer while setting it up by pressing the stop button; After the timer has been set, you can cancel it by pressing the stop button twice.

Operation Instructions

Timed Cooking Function

This function can only be used once the Clock has been set up on the appliance and the unit is in standby mode:

- 1.) Press "Timer" twice. The display will show "🕒" and "End".
- 2.) Press "<>" to set how many hours (if any) the oven will be cooking for.
- 3.) Press the "Timer" button again.
- 4.) Press "<>" to set how many minutes the unit will be cooking for.
- 5.) Press "Function" to choose the cooking function you wish to use.
- 6.) After choosing how long the unit will cook for and the temperature, press "Start".

Starting/Pausing/Canceling a Function

1.) If the cooking time has been set, press "Start" to start cooking. Press "Start" to resume cooking if it has been paused.

2.) In the cooking process, press "Pause" once to pause the cooking.
cancel

Press "Pause" twice to cancel the cooking function altogether.
cancel

Operation Instructions

Energy-Saving Function

This oven has an energy-saving function. **This function can only be set when the oven is in Standby Mode.** To start energy-saving mode:

1.) In standby mode, press "**Start**" for three seconds, the LCD display will turn off and the unit will enter energy-saving mode.

2.) If there is no oven operation within 10 minutes while the unit is in **Standby Mode**, the LCD display will turn off and the unit will enter **Energy-Saving Mode**.

3.) While in **Energy-Saving Mode**, pressing any key on the oven's control panel will cancel Energy-Saving Mode.

NOTES:

- The oven lamp will be **ON** for all functions.
- If the cooking program/setting has been set and the "**Start**" button is **not** pressed within 5 minutes, the clock will be displayed or the display will return to its default state, and the cooking program/setting will need to be set again. The unit will make a sound once the button is pressed, if not pressed there will be no response.
- The unit will ring 5 times to alert you when cooking has finished.

Accessories

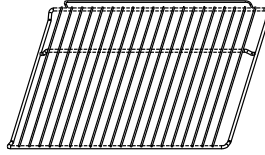

Wire Shelf

For grilling, dishes, or cake pans with items that will be grilled and/or roasted.

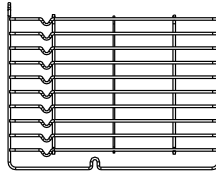

Slider Shelf

For cooking larger-sized food, these shelf support rails on the right and left sides of the oven can be removed, so dishes and trays can be placed on the oven floor to use functions such as Radiant Grilling, Double Grilling, and Double Grill with Fan.

NOTE: When placing cookware on the oven floor, please DO NOT use any functions with the Bottom Heater, in order to prevent heat gathering at the bottom.

Shelf Placement Warning

Shelf Placement Warning

To ensure the oven shelves are used safely, correct shelf placement between the side rails is important. Shelves and pans only can be used between the first and fifth layers.

The shelves should be used correctly with the side rails, as it will ensure that during careful removal of the shelf or tray and so any hot food will not slide out and cause injuries.

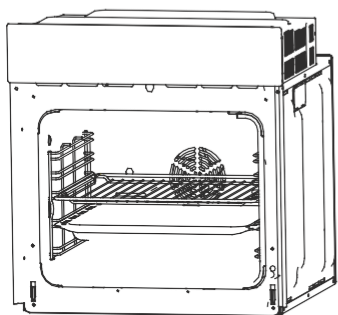

OR

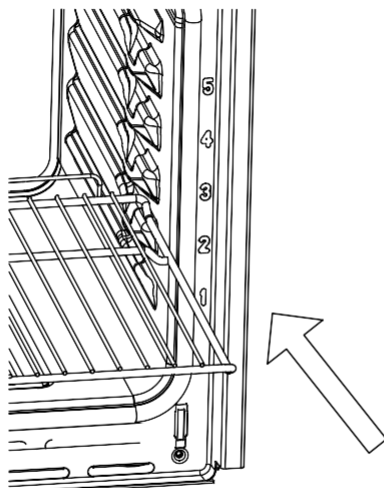
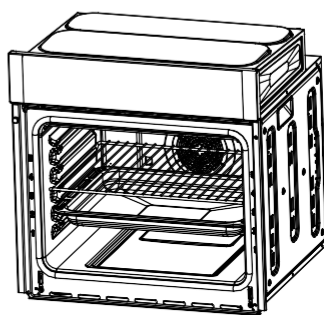

Lightbulb Replacement

Lightbulb Replacement

- 1.) Disconnect the power to the main outlet or shut off the circuit breaker to the unit's power supply.
- 2.) Unscrew the glass lamp cover by turning it counter-clockwise (**NOTE:** It may be stiff) and replace the lightbulb with a new one of the same type.
- 3.) Screw the glass lamp cover back in place.
- 4.) Reconnect the unit to its power supply.

NOTE: Only use 130V/25W halogen lamps.

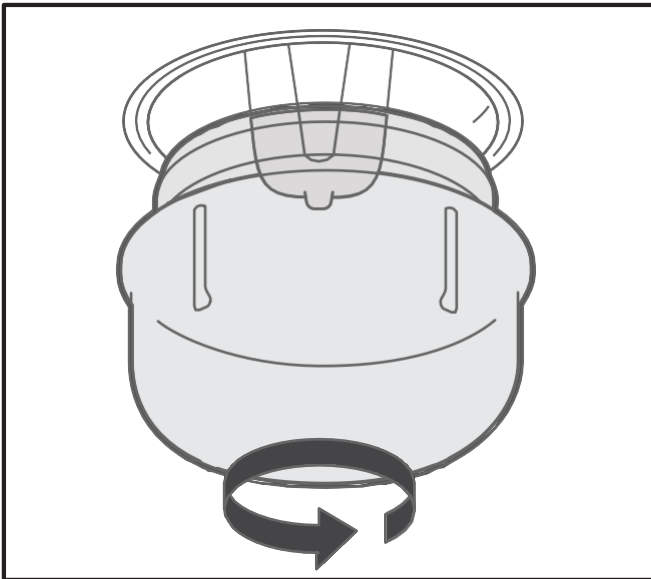

Securing the Oven to the Cabinet

Securing the Oven to the Cabinet

- 1.) Place the oven in the cabinet recess.
- 2.) Open the oven door.
- 3.) Secure the oven to the kitchen cabinet using the two spacers " A " which fit inside the holes in the oven frame. Then insert the two screws " B " into the spacers.

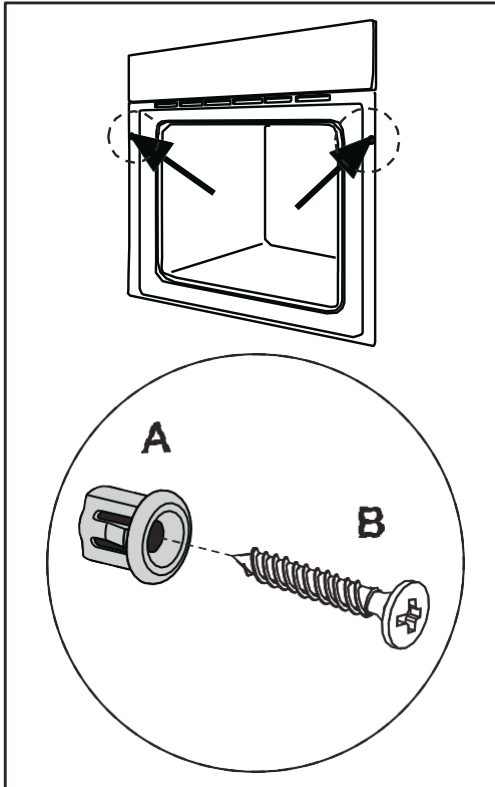

Ventilating Openings

When cooking is finished, paused, or the unit is in Standby Mode **-AND-** if the oven's center temperature is over 160 degrees, the cooling fan will continue working for 15 minutes, - **OR-** when the oven's center temperature becomes lower than 160 degrees, the cooling fan will stop working.

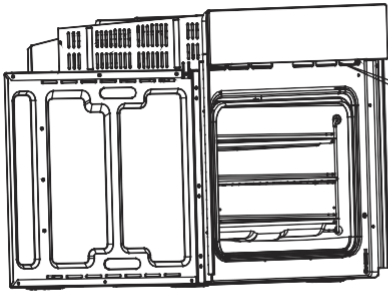

Ventilating openings

Electrical Connection

This appliance must be properly installed and grounded by a qualified technician. Ask your dealer to recommend a qualified technician or an authorized repair service.

This appliance is manufactured with a green GROUND wire connected to the oven chassis. After making sure that the power has been turned off, connect the flexible conduit from the oven to the junction box using a U.L. listed conduit connector. Figures 1 and 2 and the instructions provided below show the most common way of connecting the oven.

Your local codes and ordinances take precedence over these instructions.

Complete electrical connections according to local codes and ordinances. **“WARNING”** Risk of Electric Shock, frame grounded to neutral of the appliance through a link. Grounding through the neutral conductor is prohibited for new branch-circuit installations (1996 NEC); mobile homes; and recreational vehicles, or in an area where local codes prohibit grounding through the neutral conductor.

For installations where grounding through the neutral conductor is prohibited:

- Disconnect the ground from the neutral at free end of the conduit
- Use grounding terminal or lead to ground unit
- Connect neutral terminal or lead to branch circuit neutral in usual manner

Electrical Connection

Wire Branch Circuit

Refer to Figure:

- Disconnect ground from neutral at free end of the conduit.
- Connect the green GROUND wire from the oven to the GROUND wire in the junction box (bare or green-colored wire).
- Connect the red and black leads from the oven to the corresponding HOT Wires in the junction box.
- Connect the white wire from the oven to the NEUTRAL (gray or white) wire in the junction box.
- Connect the local codes and power supply codes using a terminal.
- The terminal uses a thing adapting to the wire of the cord.

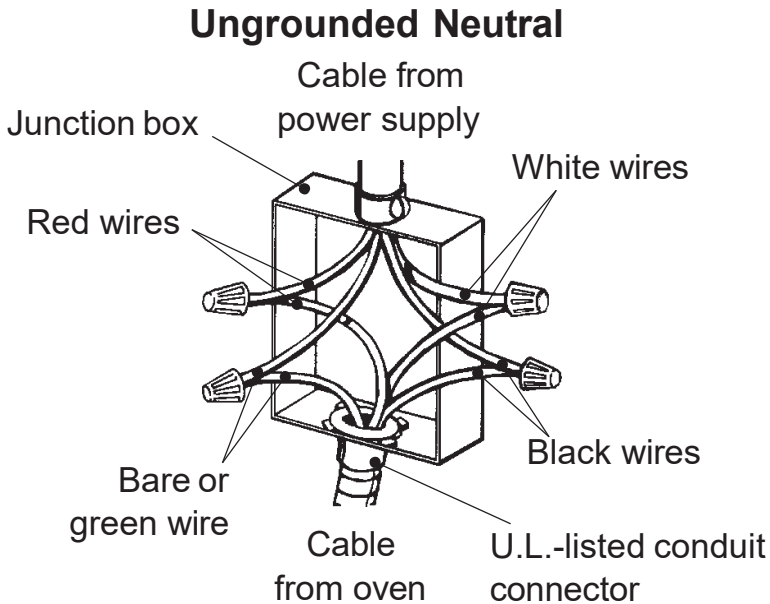

Figure

Electrical Connection

IMPORTANT: Use twist-on connector with square-wire spring

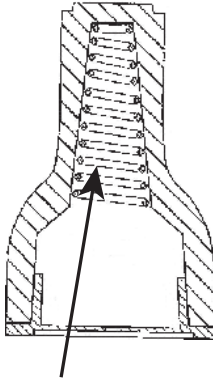

Square-wire spring

OR

From power supply

Terminal Block

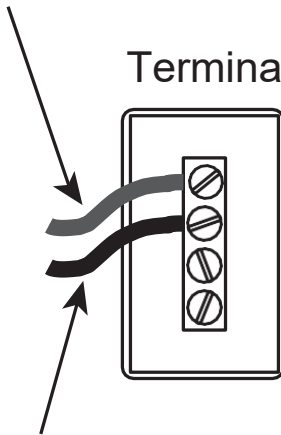

From the oven

Oven Installation

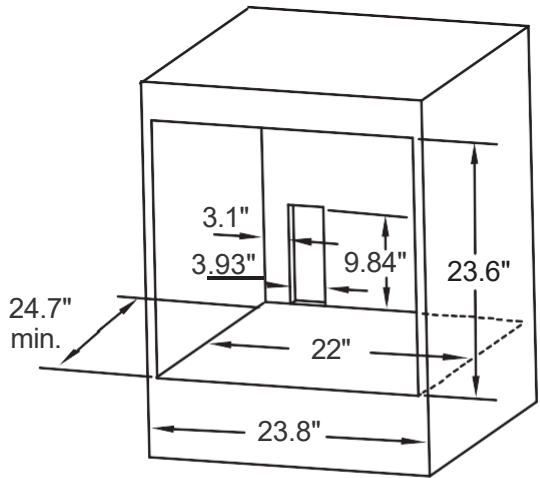
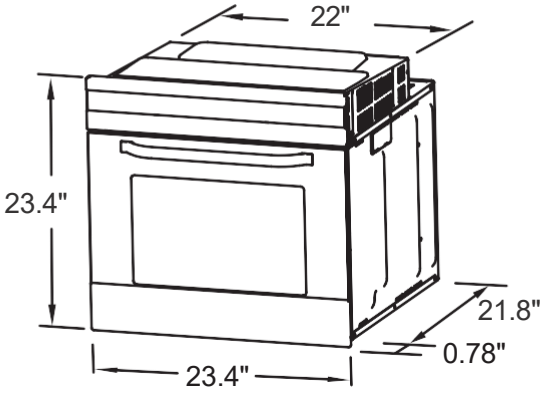

NOTES:

- Only deviations that add clearance space are allowed for all dimensions.
- The cabinet does not include the power switch or socket.
- The number of accessories included depends on the appliance purchased.

Removing the Oven Door

The removable oven door allows full access to entire interior of the oven for easier and quicker maintenance.

1.) To remove the door, open the door to the maximum angle. Then pull the buckle at the door hinge backward.

(Figure 1)

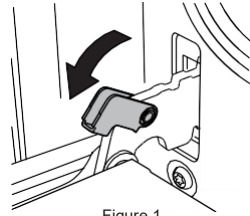

Figure 1

2.) Close the door to an angle of approximately 15°. Lift up and slowly pull the door out from the oven. (Figure 2)

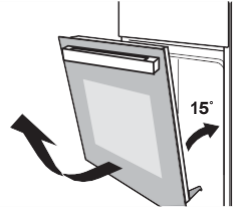

Figure 2

3.) Place the door flat with the door top cover towards yourself, put your hands on the glass, and pull it toward the oven.

(Figure 3)



Figure 3

4.) Separate the glass carefully by lifting it at approximately 25°.

(Figure 4)

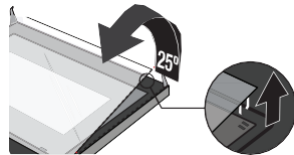

Figure 4

5.) Push the glass into the position indicated by the arrow in Figure 5. Gently pull the glass out of the socket.

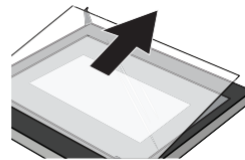

Figure 5

6.) After pulling out the inner glass, please take out the middle layer of glass as shown in Figure 6.

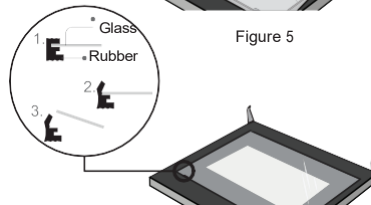

Figure 6

7.) When cleaning is completed, follow steps 1-6 to reinstall the oven door in its original position.

Cleaning & Maintenance

To keep the appliance looking good and performing well, we strongly recommend keeping the unit clean. While the modern design of the appliance keeps maintenance to a minimum, the parts of the unit that come into contact with food must be cleaned regularly.

- **Before any maintenance and cleaning is done, disconnect the power.**
- **Set all appliance controls to the OFF position.**
- **Wait until the inside of the unit has cooled completely before cleaning; use caution and ensure the oven is NOT hot or warm.**
- Clean the surface of the unit with a damp cloth, soft brush, or fine sponge, and then wipe dry. In case of heavy soiling, use hot water with a non-abrasive cleaning product.
- When cleaning the glass oven door, do NOT use abrasive cleaners or sharp metal scrapers, these can scratch the surface or lead to the glass being damaged.
- Never leave acidic substances (Such as lemon juice or vinegar) on stainless steel parts.
- Do NOT use a high-pressure cleaner for cleaning the unit.
- The baking pans may be washed in mild detergent.

NOTE: If you encounter any issues that cannot be resolved by the information in this user manual, call our Customer Service facility at **800-932-4267** between 9:00 AM and 5:00 PM ET or visit our website summitappliance.com/support at any time. We will do our best to answer your questions

NOTES

WARRANTY AND SERVICE

ONE-YEAR LIMITED WARRANTY

Within the 48 contiguous United States, for one year from the date of purchase, when this appliance is operated and maintained according to instructions attached to or furnished with the product, warrantor will pay for factory-specified parts and repair labor to correct defects in materials or workmanship. Service must be provided by a designated service company. Outside the 48 states, all parts are warranted for one year from manufacturing defects. Plastic parts, shelves, and cabinets are warranted to be manufactured to commercially acceptable standards and are not covered from damage during handling or breakage.

ITEMS WARRANTOR WILL NOT PAY FOR:

1. Service calls to correct the installation of your appliance, to instruct you how to use your appliance, to replace or repair fuses or to correct wiring or plumbing.
2. Service calls to repair or replace appliance light bulbs or broken shelves.
Consumable parts (such as filters) are excluded from warranty coverage.
3. Damage resulting from accident, alteration, misuse, abuse, fire, flood, acts of God, improper installation, installation not in accordance with electrical or plumbing codes, or use of products not approved by warrantor.
4. Replacement parts or repair labor costs for units operated outside the United States.
5. Repairs to parts or systems resulting from unauthorized modifications made to the appliance.
6. Expenses for travel and transportation for product service in remote locations.
7. The removal and reinstallation of your appliance if it is installed in an inaccessible location or is not installed in accordance with published installation instructions.

DISCLAIMER OF IMPLIED WARRANTIES; LIMITATION OF REMEDIES

CUSTOMER'S SOLE AND EXCLUSIVE REMEDY UNDER THIS LIMITED WARRANTY SHALL BE PRODUCT REPAIR AS PROVIDED HEREIN. IMPLIED WARRANTIES, INCLUDING WARRANTIES OF MERCHANTABILITY OR FITNESS FOR A PARTICULAR PURPOSE, ARE LIMITED TO ONE YEAR. WARRANTOR SHALL NOT BE LIABLE FOR INCIDENTAL OR CONSEQUENTIAL DAMAGES. SOME STATES DO NOT ALLOW THE EXCLUSION OR LIMITATION OF INCIDENTAL OR CONSEQUENTIAL DAMAGES, OR LIMITATIONS ON THE DURATION OF IMPLIED WARRANTIES OF MERCHANTABILITY OR FITNESS, SO THESE EXCLUSIONS OR LIMITATIONS MAY NOT APPLY TO YOU. THIS WARRANTY GIVES YOU SPECIFIC LEGAL RIGHTS AND YOU MAY ALSO HAVE OTHER RIGHTS, WHICH VARY FROM STATE TO STATE.

FELIX STORCH, INC.
770 Garrison Avenue
Bronx, NY 10474

Phone: (718) 893-3900

Fax: (844) 478-8799

www.summitappliance.com



For parts and accessory ordering, troubleshooting, and helpful hints, visit:

www.summitappliance.com/support