



KEGERATOR WITH FLOATING TOWER

Models:



SBC54OSFLTW
SBC56BGSSFLTW
SBC56GWFLTW
SBC58BSSFLTW
SBC58BLFLTW
SBC58WHFLTW
SBC56BGFLTW
SBC56GWHFLTW
SBC7BFLTW

ALBC7BFLTW
SBC7WFLTW
ALBC7WFLTW
SBC682FLTW
SBC683OSFLTW
BC3TFLTW
WBC3FFLTW
LBC24OSFLTW
BC74OSFLTW

WBC3ZOSFLTW
LBC243TFLTW
SBC7BRSFLTWADA
SBC58BLIFFLTWADA
SBC7BRSFCFLTWADA
SBC58BLIFCFFLTWADA

Instruction Manual

BEFORE USE, PLEASE READ AND FOLLOW ALL SAFETY RULES AND OPERATING INSTRUCTIONS

Write Model and Serial Numbers here:

Model: _____

Serial No. _____

Felix Storch, Inc.
An ISO 9001:2015 registered
company
770 Garrison Ave Bronx,
New York 10474
www.summitappliance.com

Table of Content

Important Safeguards	3 – 5
Location of Parts & Accessories	6
Installation Instructions	7 – 11
Before Using Your Appliance	7
Installing Your Appliance	7
Electrical Connection	8
Extension Cord	8
Reversing the Door Swing	9
Door Handle Installation	9
Installing the Casters	10
Adjusting the Tilt	10
Leg Shield	10
Beer Kegs and Keg Tappers	11 – 12
Assembling the Floating Tap	11
Assembling the CO ₂ Regulator and CO ₂ Tank	11
Installing the CO ₂ Tank	12
Installing the Beer Keg	12
Coffee and Wine Keg Tappers	13 – 16
Assembling the N ₂ Canister	13
Installing the Cold Brew Coffee Tap Kits	14 – 15
Installing Wine Keg Tap on Single Barrel Type Keg	15 – 16
Operating Your Appliance	17 – 20
Temperature Control	17 – 18
Mechanical Thermostat	17
Digital Thermostat	17 – 18
Defrosting Your Appliance	18
Care and Maintenance	19 – 20
Cleaning Your Appliance	19
Emptying Beer Line	19
Power Failure	20
Vacations	20
Moving Your Appliance	20
Energy-Saving Tips	20
Troubleshooting	21 – 22
Limited Warranty	24

IMPORTANT SAFEGUARDS

Your safety and the safety of others are very important.



Before the unit is used, it must be properly positioned and installed as described in this manual, so read the manual carefully. To reduce the risk of fire, electrical shock or injury when using the appliance, follow basic precautions, including the following:

DANGER

- Plug into a grounded 3-prong outlet. Do not remove grounding prong, do not use an adapter, and do not use an extension cord.
- It is recommended that a separate circuit, serving only your unit, be provided. Use receptacles that cannot be turned off by a switch or pull chain.
- Never clean appliance parts with flammable fluids. These fumes can create a fire hazard or explosion. And do not store or use gasoline or other flammable vapors and liquids in the vicinity of this or any other appliance. The fumes can create a fire hazard or explosion.
- Before proceeding with cleaning and maintenance operations, make sure the power line of the unit is disconnected.
- Do not connect or disconnect the electric plug when your hands are wet.
- Unplug the appliance or disconnect the power before cleaning or servicing. Failure to do so can result in electrical shock or death.
- Do not attempt to repair or replace any part of your unit unless it is specifically recommended in this material. All other servicing should be referred to a qualified technician.
- This appliance is CFC- and HFC-free and contains small quantities of Isobutane (R600a) which is environmentally friendly, but flammable. It does not damage the ozone layer, nor does it increase the greenhouse effect. Care must be taken during transportation and setting up of the appliance that no parts of the cooling system are damaged. Leaking coolant can ignite and may damage the eyes.

In the event of any damage:

- Avoid open flames and anything that creates a spark.
 - Disconnect from the power source.
 - Air the room in which the appliance is located for several minutes.
 - Contact the Service Department for advice.
-
- The more coolant there is in an appliance, the larger the room in which it should be installed. In the event of a leakage, if the appliance is in a small room, there is the danger of combustible gases building up. For every ounce of coolant, at least 325 cubic feet of room space is required. The amount of coolant in the appliance is stated on the data plate inside the appliance. It is hazardous for anyone other than an Authorized Service Person to carry out servicing or repairs to this appliance.
 - Take serious care when handling, moving, and using the appliance to avoid either damaging the refrigerant tubing or increasing the risk of a leak.
 - Replacing component parts and servicing shall be done by factory-authorized service personnel so as to minimize the risk of possible ignition due to incorrect parts or improper service.

WARNING

- Use two or more people to move and install the unit. Failure to do so can result in back or other injury.
- To ensure proper ventilation for your appliance, the front of the unit must be completely unobstructed. Choose a well-ventilated area with temperatures above 60°F (16°C) and below 90°F (32°C). This unit must be installed in an area protected from the elements, such as wind, rain, water spray, or drips.
- The appliance should not be located next to ovens, radiators, or other sources of high heat.
- The appliance must be installed with all electrical connections in accordance with state and local codes. A standard electrical supply (115V AC only, 60 Hz), properly grounded in accordance with the National Electrical Code and local codes and ordinances, is required.
- Do not kink or pinch the power supply cord of the appliance.
- The fuse (or circuit breaker) size should be 15 amperes.
- It is important for the unit to be leveled in order to work properly. You may need to make several adjustments to level it.
- Never allow children to operate, play with or crawl inside the unit.
- Do not use solvent-based cleaning agents or abrasives on the interior. These cleaners may damage or discolor the interior.
- Do not use this apparatus for other than its intended purpose.
 - **WARNING!** Keep ventilation openings, in the appliance enclosure or in the built-in structure, clear of obstruction.
 - **WARNING!** Do not use mechanical devices or other means to accelerate the defrosting process, other than those recommended by the manufacturer.
 - **WARNING!** Do not damage the refrigerant circuit. This will also prevent pollution.
 - Do not store explosive substances such as aerosol cans with a flammable propellant in this appliance.
 - **WARNING!** This appliance is intended to be used in household and similar applications such as
 - staff kitchen areas in shops, offices, and other working environments.
 - farmhouses and by clients in hotels, motels, and other residential-type environments.
 - bed and breakfast type environments.
 - catering and similar non-retail applications.
 - **WARNING!** If the supply cord is damaged, it must be replaced by the manufacturer, its service agent, or similarly qualified persons in order to avoid a hazard.

DANGER

Risk of child entrapment!

Child entrapment and suffocation are not problems of the past. Junked or abandoned units and freezers are still dangerous, even if they will “just sit in the garage a few days.”

- **Before you throw away your old unit or freezer:** Take off the doors. Leave the shelves or drawers in place so that children may not easily climb inside.
- Never allow children to operate, play with, or crawl inside the appliance.

THIS APPLIANCE IS NOT INTENDED FOR USE BY YOUNG CHILDREN OR INFIRM PERSONS UNLESS THEY HAVE BEEN ADEQUATELY SUPERVISED BY A RESPONSIBLE PERSON TO ENSURE THAT THEY CAN USE THE APPLIANCE SAFELY. YOUNG CHILDREN SHOULD BE SUPERVISED TO ENSURE THAT THEY DO NOT PLAY WITH THE APPLIANCE.

WARNING: CO₂ cylinders contain high-pressure gas which can be hazardous if not handled properly. Make sure you READ and UNDERSTAND the following procedures for CO₂ cylinders BEFORE installation.

1. **ALWAYS** connect the CO₂ cylinder to a regulator. Failure to do so could result in an explosion with possible death or injury when the cylinder valve is opened.
2. **NEVER** connect the CO₂ cylinder directly to the product container. Doing so will result in an explosion causing possible death or injury.
3. **ALWAYS** follow correct procedures when cylinders are changed.
4. **ALWAYS** secure the cylinder in an upright position with a chain.
5. **NEVER** drop or throw a CO₂ cylinder.
6. **ALWAYS** keep a CO₂ cylinder away from heat. Store extra cylinders in a cool place (preferably 70°F). Securely fasten with a chain in an upright position when storing. **NEVER** place cylinders in direct sunlight or where the temperature could rise above 130°F.
7. **ALWAYS** ventilate and leave the area immediately if CO₂ gas leakage has occurred. **NEVER** enter a closed area where leakage may have occurred without making certain it has been ventilated.
8. **ALWAYS** check the D.O.T. test date on the cylinder neck before installation. If over five (5) years, do not use, return cylinder to gas supplier.
9. **NEVER** connect a product container unless there are two (2) safeties in the pressure system:
 - (a) one at or on the CO₂ regulator
 - (b) one at or on the product coupler or in the pressure gas line
10. CO₂ Regulators are delicate instruments and should be checked constantly for creeping, sluggishness, damaged gauges, or any unusual behavior. If any of these symptoms occur discontinue use immediately and return the regulator to the supplier or manufacturer

CAUTION: Failure to connect the regulator by properly following these instructions may result in leaks explosions, asphyxiation, and cause serious personal injury or death.

- SAVE THESE INSTRUCTIONS -

Location of Parts

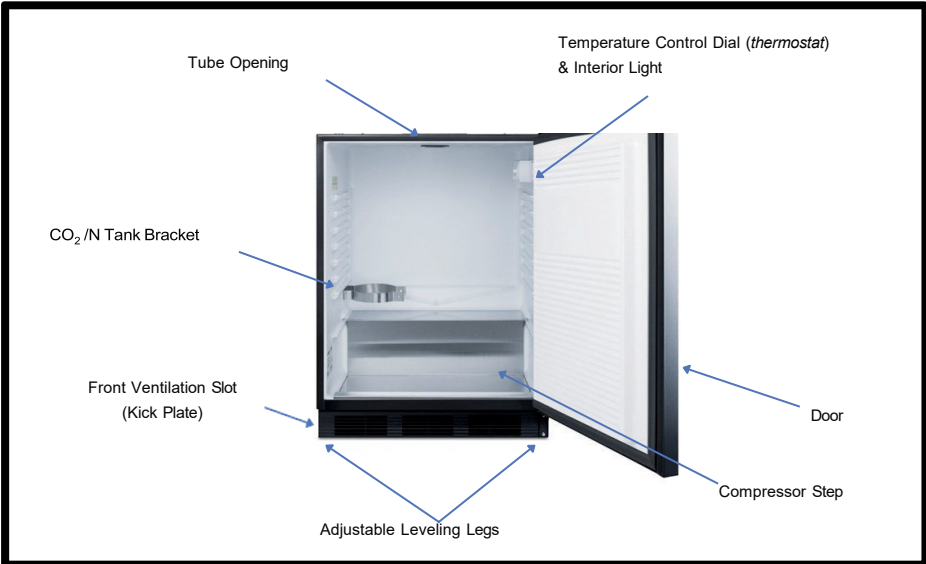
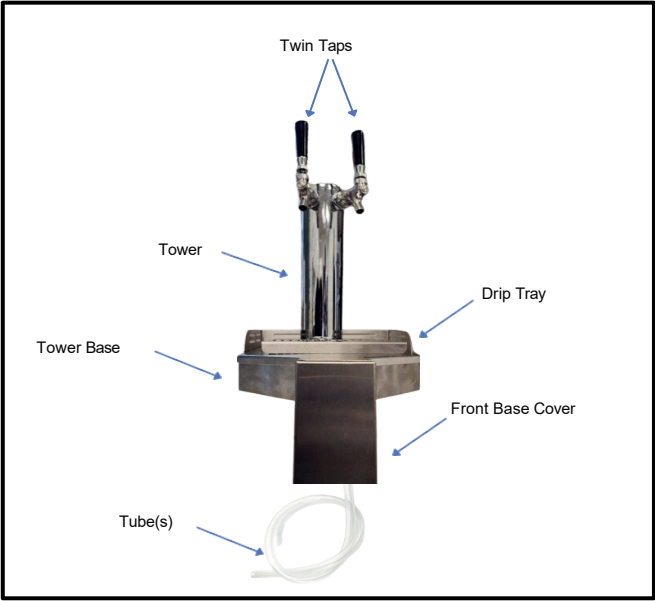

Accessories

							
Tower	Tower Base	Front Base Cover	Screw (6)	Drip Tray	Insulation Plug (for tubes)	Insulation Plug (no tubes)	Shelves

Note: This user manual is prepared for more than one model. Some of the features specified in the manual may not be available in your appliance. Specifications are subject to change without notice.

Note: Save the insulation plug and shelves if you wish to convert your kegerator into a refrigerator.

Installation Instructions

Before Using Your Appliance:

- Remove the exterior and interior packing.
- Before connecting the unit to a power source, let it stand for approximately 2 hours. This will reduce the possibility of a malfunction in the cooling system from handling during transportation.
- Remove the shelves and clean them and the interior surfaces of the unit with lukewarm water using a soft cloth.

Installing Your Appliance:

1. Place the unit on a floor that is strong enough to support it when the appliance is fully loaded. To level the unit, adjust the two leveling legs at the front.
2. This appliance is designed for freestanding use or recessed installation in a 24- inch wide (minimum) opening. Please allow 2" clearance in the back and some airflow on the sides and top of the units. The bottom grill must never be covered or blocked. If rear spacers are provided with your specific model, they must be installed.
3. This appliance is supplied with spacers which must be mounted onto the condenser tube at the back to make sure there is sufficient clearance between the appliance and the wall.

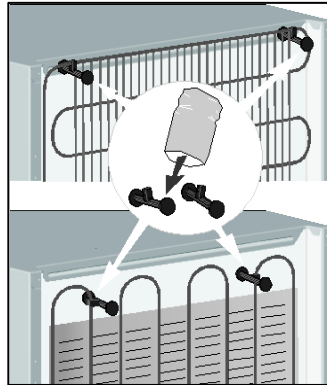

4. Locate the unit away from direct sunlight and sources of heat (oven, heater, radiator, etc.). Direct sunlight may affect the acrylic coating and heat sources may increase electrical consumption. Extremely cold ambient temperatures may also affect the unit's performance.
5. Avoid locating the unit in moist areas. Too much moisture in the air will cause frost to form quickly on the evaporator, requiring more frequent defrosting of the interior.
6. Plug the unit into an exclusive, properly installed, and grounded wall outlet. Any questions concerning power and/or grounding should be directed toward a certified electrician or authorized service center.

Electrical Connection:



WARNING

Improper use of the grounded plug can result in the risk of electrical shock. If the power cord is damaged, have it replaced by the manufacturer, its service agent, or similarly qualified persons in order to avoid a hazard.

- This unit should be properly grounded for your safety. The power cord of this unit is equipped with a three-prong plug which mates with a standard three-prong wall outlet to minimize the possibility of electrical shock.
- Do not under any circumstances cut or remove the third ground prong from the power cord supplied. For personal safety, this appliance must be properly grounded.
- This unit requires a standard 115-volt AC/60Hz electrical outlet with three-prong ground. Have the wall outlet and circuit checked by a qualified electrician to make sure the outlet is properly grounded. When a standard 2-prong wall outlet is encountered, it is your responsibility and obligation to have it replaced with a grounded 3-prong wall outlet.
- To prevent accidental injury, the cord should be secured behind the unit and not left exposed or dangling. The unit should always be plugged into its own individual electrical outlet which has a voltage rating that matches the rating label on the appliance. This provides the best performance and prevents overloading house wiring circuits that could cause a fire hazard from overheated wires. Never unplug the unit by pulling on the power cord.
- Always grip the plug firmly and pull straight out from the receptacle. Repair or replace immediately any power cord that has become frayed or otherwise damaged. Do not use a cord that shows cracks or abrasion damage along its length or at either end.
- When moving the unit, be careful not to damage the power cord.

Extension Cord:

Do not use an extension cord with this appliance. If the power cord is too short, have a qualified electrician or service technician install an outlet near the appliance.

Reversing the Door Swing:

NOTE:

- If your unit's handle is positioned horizontally, you do not need to change the handle placement.
- Some units' doors may not be user reversible.

If you find the direction of opening the door of the appliance inconvenient, you can change it. Holes on the opposite side have already been prepared at the factory.

This appliance can be opened from either the right side or the left. By default, the door hinge is on the right side. If you prefer it on the left, please follow these instructions:

1. Take off the upper hinge cover from the door and remove the screws that hold the top hinge.
2. Lift the hinge straight up to free the hinge pin from the socket at the top of the door.
3. Lift the door up and away to free its bottom socket from the hinge pin.
4. Remove the screws to the bottom hinge.
5. Remove the decorative caps from the opposite side and plug the holes from the original side with the decorative caps.
6. Move the bottom hinge to the opposite side and tighten the screws. Use any lock washers or nuts if they were used in the original installation.
7. Replace the door with the hinge pin on the bottom hinge. Place the top hinge pin into the door. Insert screws into the top hinge and tighten.

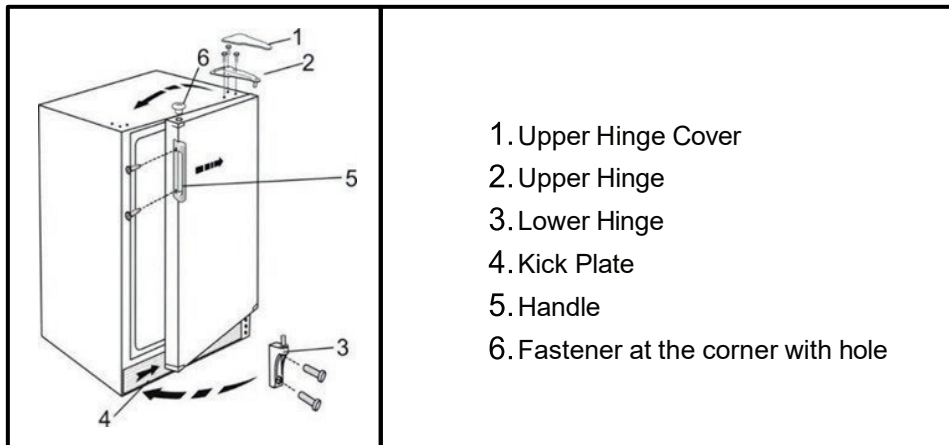

Door Handle Installation:

NOTE: Some units ship with a stainless steel handle that does not require user-installation. Units that are panel-ready do not include a handle.

The door has two screw holes on each side, allowing you to install a handle (included). To do so, align the handle with the screw holes on the side you prefer. Fix the handle in place with the included screws, then cover the screw heads with the handle seal (included).

Installing the Casters (optional):

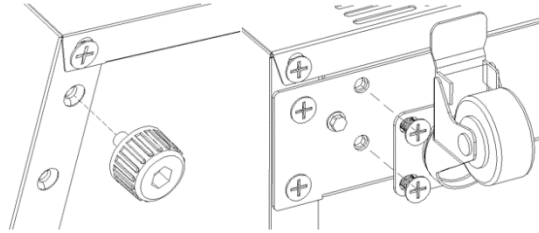

1. Remove everything from the cabinet and lay the unit on a clean, dry, and padded surface.
2. Remove the four feet at the bottom of the unit as shown, install caster into the holes and tighten with a Phillips screwdriver.
3. The two casters equipped with locks should be installed on the front of the unit.
4. Once all four casters are attached, return the kegerator to an upright position. Allow the unit to sit for 8-10 hours before plugging in to allow the refrigerant to settle.

Adjusting the Tilt:

If your beer cooler seems unsteady or you would like the door to close more easily, you can use the leveling legs to adjust the tilt of the unit.

Be sure that the unit is in its final position when adjusting the tilt and that it is plugged into a grounded 3-prong outlet.



WARNING:

Two or more people are required to move and/or install the refrigerator. Failure to do so may cause back or other injury.

- Turning a leveling leg to the right will lower the appliance toward the position of the leg. Likewise, turning to the left will raise the unit away from the leg.
- Several turns of the leveling legs may be required before the tilt of the appliance is properly adjusted.
- Turning both front legs an equal amount to the left will tilt the kegerator towards the rear. This adjustment makes it easier for the door to close.

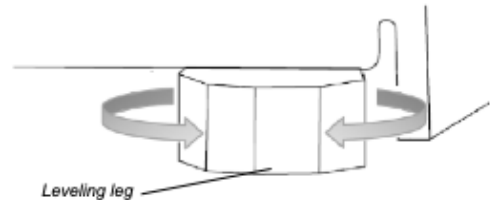

Note: It is easier to adjust the leveling legs if someone else pushes against the top of the appliance to take the weight off the legs.

Leg Shield:

Note: Some models include a leg shield meant to cover the exposed legs and the gap from the bottom of your unit to the floor for a cleaner look. This feature may not be available on all appliances.

Beer Kegs and Keg Tappers:

Your kegerator cooler comes with a double tap and will accommodate two "Sixth Barrel" kegs, also known as "sixtels" or "logs". Each sixtel has a height of 23-3/8" and a diameter of 9-1/4" and hold 5.16 gallons of beer. Two Cornelius ("Corny") kegs will also fit. The unit will not hold a half barrel or quarter barrel, although it can take one "Slim Quarter" barrel.

The Sankey type keg tappers supplied with the kegerator are the most widely used in the United States. However, other types of keg tappers can be used. Before installing a keg tapper, check with your beer distributor to make sure that the Sankey type keg tapper can be used.

If you need keg tappers other than the Sankey type, it is recommended that you purchase the tappers you need from your beer distributor. Please keep the Sankey type keg tappers for future use. The Sankey system is becoming more popular. It may be purchased from our sales department at **(800) 932-4267**.

Floating Tap Kegerator:

This unit allows the users to install a kegerator under a counter without the need to drill a hole for a beer tower. A 2" - 2 1/4" space is necessary between the top of the kegerator and the counter to ensure the tubes function correctly.

Note: The tubes are pre-installed to the tower for easy installation. Do not attempt to pull the tubing out of the tower or the base.

Assembling the Floating Tap:

1. Stand the tower on top of the base and screw into place.
2. Screw the front base cover to the mouth of the base.
3. Determine where the tower will be mounted on the counter space.
4. Ensure the area on the counter is properly clean and dry.
5. Lay the unit on its back to remove the protective film from under the base.
6. Lift the tower at the base ensuring the adhesive does not touch the counter.
7. Tilt the tower towards you and align the mouth of the base to the edge of the counter.
8. Drop the tower into place and apply an even amount of pressure to the base.
9. Hold the end of the tubes together with the insulation plug.
10. Push the plug with the tubes into the opening on top of the kegerator.
11. Push the kegerator in place and open the door.
12. Pull the tubes from inside the kegerator to connect them to the keg.
13. Place the drip tray on top of the base.

Note: Refer to the care and maintenance section of this manual for important instructions on how to clear the beer line, located on page 20.

Assembling CO₂ Regulator and CO₂ Tank:

Note: Your CO₂ cylinder is shipped empty to avoid any possible accidents during transportation. **When you purchase the first keg of beer, have your beer distributor fill the CO₂ cylinder. You must read and understand the following procedures for CO₂ cylinders before installation:**

1. Install the CO₂ gas line tube to the regulator by attaching one end of the red tube to the hose connection on the CO₂ regulator.
2. Secure the tube by using one of the self-locking black plastic snap-on clamps.
3. Insert a special washer into the regulator-to-cylinder attachment nut.
4. Attach the CO₂ regulator to the CO₂ cylinder by screwing the regulator nut onto the cylinder valve and tightening it with an adjustable wrench.
5. Remove the bolt with the nut from the cylinder retainer. Using two screws, attach it inside the unit on the left side of the back wall. Holes are pre-drilled, and screws are included.
6. Slide the cylinder through the retainer and secure it with the bolt and the nut. Position the cylinder this way so that you will be able to read the numbers on the gauges and easily access the shut-off valve.

Installing the CO₂ Tank:

1. Install CO₂ gas cylinder and CO₂ regulator valve (for beer):
 - a. Remove the protective covering from the coupler's gas line.
 - b. Fix the two CO₂ hose clamps on the red CO₂ tube. (**See Figure 1**)
 - c. Connect the ends of the red CO₂ tube respectively to the CO₂ intake port of the coupler and the round outlet of the CO₂ regulator valve. Lock these connections firmly with the two clamps on the red CO₂ tube. (**See Figure 2**)
 - d. Using the wrench, tighten the CO₂ regulator table valve with the hex nut port to the gas outlet of the CO₂ tank. (**See Figure 3**)

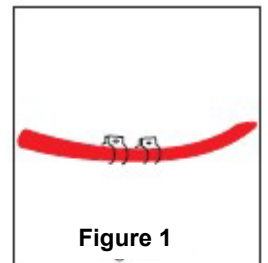

Installing the Beer Keg:

1. Place the CO₂ tank and CO₂ regulator valve component into the cabinet and fix the CO₂ tank with tank bracket and retainer. (**See Figure 3**)

Note:

Some units can hold 2 one-sixth barrel kegs, but not a full-size keg. Place the beer keg into the cabinet and firmly connect the keg's opening to the connection port of the coupler.

- a. Hold the keg by the handles and move it to the front of the open beer dispenser.
- b. Raise bottom edge of the keg, aligning it to the edge of the cabinet.
- c. Lift the keg to the same level of the cabinet floor.
- d. Push the keg into place.
- e. Arrange the hose(s) behind the keg, this will help the door to close properly.

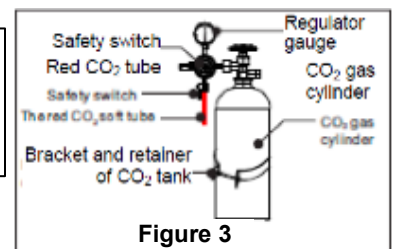

2. Screw the tap handle on to the beer tap. (**See Figure 4**)



Note:

- When replacing the beer keg, first turn off the safety switch on the CO₂ regulator valve and remove the coupler to take out the keg.
- When replacing the CO₂ gas cylinder, remember to turn off the main switch of the CO₂ gas cylinder and the safety switch on the CO₂ regulator valve. Afterward, use a wrench to loosen the hexagonal nut port connecting the CO₂ regulator valve with the CO₂ tank. Then, using a wrench, remove the fixed bolt of the CO₂ tank to take out the CO₂ tank.
- During the installation process, be sure that all parts are connected tightly and that there are no gas leaks.
- When connecting the hose to the connection port, you can dip the ends into warm water to make the connection easier.
- If the high-pressure compressed gas in the CO₂ tank is not handled properly, it could be dangerous:
- Make a note of the D.O.T. testing date on the cylinder neck before installation. If it is more than 5 years old, do not use the product. Return it to the gas supplier.
- Keep gas cylinders away from heat sources. Unused cylinders should be placed upright in a cool, ventilated place (preferably at 70°F).

Coffee and Wine Tappers:

Assembling the N₂ Canister:

1. Insert the end of the gas line with the green coupler onto the bottom end of the regulator. (See Figure D and Photo 1). Secure the line to the regulator by tightening the green coupler. Secure the gas line by tightening the green coupler.
2. Insert the black rubber washer into the attachment nut into the regulator and connect the regulator to the gas canister valve. Tighten with an adjustable wrench (not provided). **DO NOT OVERTIGHTEN.** (As shown in figure E)
3. Attach the NO₂ gas line to the regulator outlet nipple and secure it with a clamp.
4. Secure the canister with the rubber restraining strap (on side of the wine keg dispenser cabinet) as shown in Figure D. Be sure to situate the canister so that the gauges are easily readable and shut-off valves are easily accessible.

SPECIAL PRECAUTIONS: Ensure that the safety devices for your pressurized system are installed and remain installed. Once installed, **NEVER** remove the rubber washers in the regulator attachment nut to the canister or in the tap mechanism. **NEVER** bypass these safety features.

Failure to comply will void your warranty and could result in serious injury or death!

Gas Regulator & Tap Connection Examples:

PLEASE NOTE: Your gas hose comes equipped and assembled with coupling connections for the regulator (green coupler) and the tap connection (silver coupler). The photos below show correct connections.

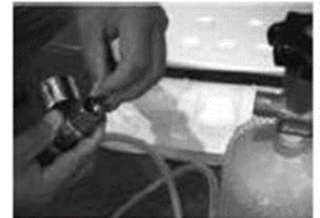
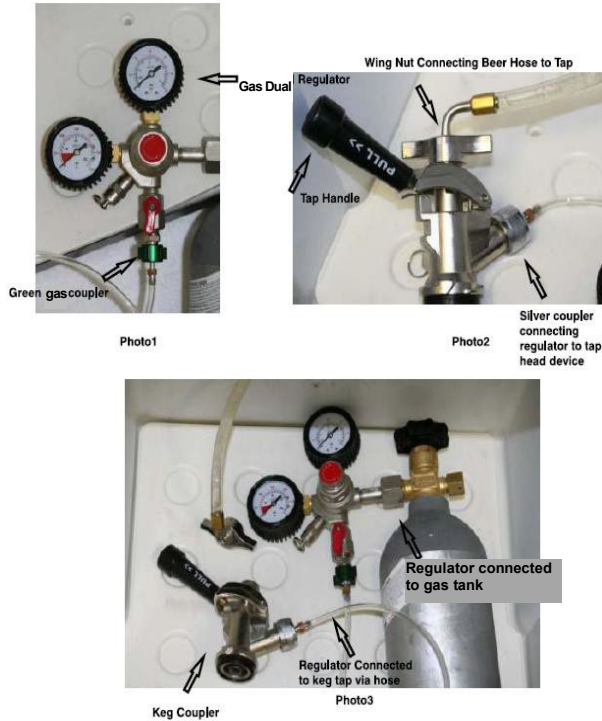

Figure E



Figure F

Installing the Cold Brew Coffee Tap Kits:



Flat Iced Coffee Kits: KitCF KitCFTWIN
 Nitro-Infused Coffee Kits: KitNCF KitNCFTWIN
 Combination Flat/Nitro Kit: KitCMTWIN

Note: This user manual is prepared for more than one model. Some of the features specified in the manual may not be available in your appliance, but most details should correspond to other kegerators as well.

1. Put draft tower directly over the hole on the top of the coffee dispenser's upper surface. Fix the tower assembly with screws directly to the upper surface of the dispenser. (**See Figure 1**)
2. Using a wrench, tighten the hex nut port on the regulator valve to the N₂ gas outlet on the N₂ gas cylinder. (**See Figure 2**)



Fig. 1

- a. Place the N₂ gas cylinder into the bracket on the rear wall of the kegerator's inside cabinet and fix the N₂ gas cylinder with the bolt. (**See Figure 3**)

Note: Some units do not include a bracket.



Fig. 3



Fig. 2

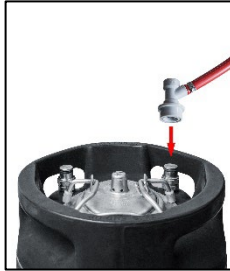

Fig. 4

4. Carefully place the keg inside the kegerator. Attach the coffee tube from the tower to the “out” post of the of the Cornelius keg by pushing the ball lock down over the “out” post until it snaps in place. (**See Figure 4**)

5. Attach the N₂ tube to the “in” post of the Cornelius keg by pushing the ball lock down over the “in” post unit it snaps on.

6. Set the desired pressure on the regulator valve. If serving flat iced coffee, open the regulator valve and set the pressure between 4-8 psi. If serving nitro-infused coffee, set the pressure between 30-45 psi.

7. Install the tap handle(s) and coffee tap(s). Screw the tap handle clockwise into the coffee tap to make a firm connection, then connect the tap to the coffee tower components and tighten with a wrench.

Note: If serving nitro-infused coffee, agitate the keg before serving.

Notes:

- These taps are designed for dispensing coffee and should not be used for milk or any other substance.
- When replacing the coffee keg, first turn the safety switch on the N₂ regulator valve and remove the ball locks to take out the keg.
- When replacing the N₂ gas cylinder, remember to turn off the main switch of the N₂ tank and the safety switch on the N₂ regulator valve. Afterwards, use a wrench to loosen the hexagonal nut port connecting the N₂ regulator valve with the N₂ tank. Then, using a wrench, remove the fixed bolt of the N₂ tank.
- During the installation process, be sure that all parts are connected tightly and that there are no gas leaks.
- High-pressured compressed gas in the N₂ tank can be dangerous if not handled properly. For optimum safety, make a note of the D.O.T. testing date on the cylinder neck before installation. If it is more than 5 years old, do not use.
- Keep the gas cylinder away from heat sources. Unused cylinders should be placed upright in a cool, ventilated place, preferably at 70°F.

Installing Wine Keg Tap on Single Barrel Type Keg:

This wine dispenser's coupler is compatible only with a single 1/6 barrel keg, although a second untapped keg can be stored behind the tapped keg to keep it cold. Each 1/6 barrel keg holds approximately 5 gallons of wine.

To Tap the Wine Keg:

1. First be sure that the black dispenser handle is pushed up, indicating an untapped keg (**See Figure 1**). Also, make sure the tower dispenser (on top of the wine dispenser) is closed before starting the tap-to-keg connection.
2. Connect the other end of the NO₂ pressure tubing to the NO₂ pressure inlet nipple on the keg coupler and secure it with a clamp. Insert the keg coupler mechanism into the top of the keg and lock it into the lugs with a one-quarter clockwise turn (**See Figure 2 & Figure 3**).
3. Open the NO₂ cylinder valve by turning the knob counterclockwise, open it all the way to be sure there are no leaks. Then, set the pressure between 5-7 psi, this accommodates most wine kegs. After the pressure is set, tighten the locknut to prevent tampering with the setting.

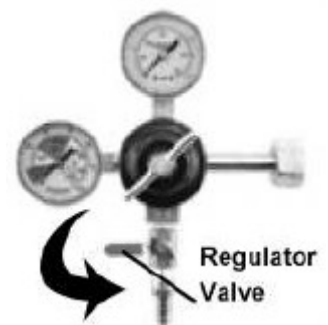

4. Connect the wine line wingnut to the keg coupler and tighten it.
5. Turn the shut-off lever down to allow the gas to flow.
6. To finalize the connection, pull the black tap handle out and push it down until it clicks securely. There will be an audible click, indicating that the gas and wine have been opened and your keg is tapped. **(See Figure 4)**
7. Open the regulator valve (top right photo) and open the valve on the gas tank.
8. Carefully, tilt the keg onto the cabinet using the keg support **(See Figure 5)** and position slowly into the cabinet body until the door can close. **HANDLE CAREFULLY.** Do not jostle or bang keg on the gas canister.



Note: The left regulator gauge indicates total tank press.

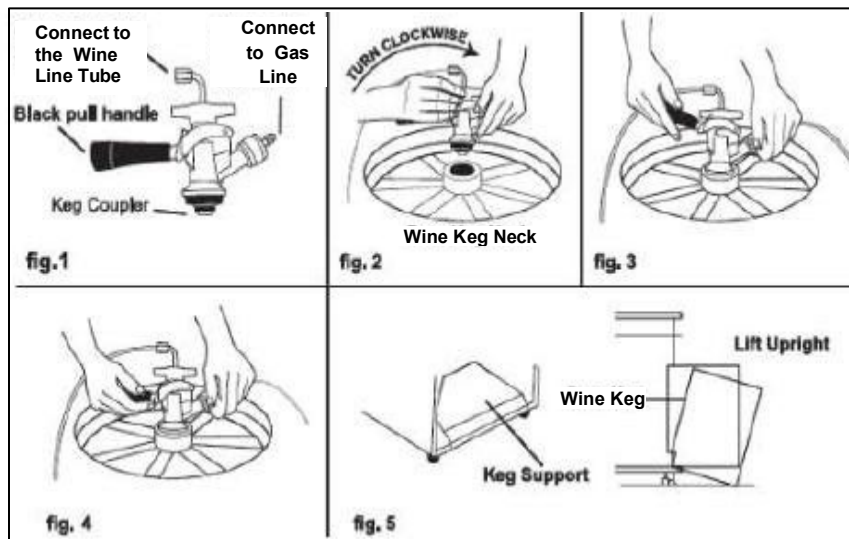

Operating Your Appliance

Temperature Control:

Your appliance may have a mechanical (dial) or digital thermostat. Listed below are instructions for both mechanical and digital thermostats.

Mechanical (dial) Thermostat (on some models):

- The interior temperature is controlled with a thermostat knob located inside the unit, towards the upper right-hand corner. Turn the knob clockwise from the **STOP (0)** position toward the higher numbers for colder temperatures. Higher settings on the knob (higher numbers) mean lower temperatures (colder) inside the unit.
- On the coldest settings, temperatures in some spots inside
- the cabinet may drop below 32°F. Use higher thermostat settings only when required or recommended. When the ambient temperature is normal, we recommend a medium setting.
- Changes in the ambient temperature affect the temperature inside the Unit so choose an appropriate setting of the thermostat knob, depending on ambient conditions.
- In the **STOP (0)** position, the appliance does not operate (the cooling system is switched off), yet the power supply is not interrupted (the light still works).
- The temperature inside the unit also depends on how often you open the door.
- In all small units without interior fans, temperatures are coldest near the bottom, and occasionally near the rear. Place contents accordingly. It is best not to operate these units mostly empty. If temperatures are erratic, try putting some water bottles inside to create a load for the compressor.

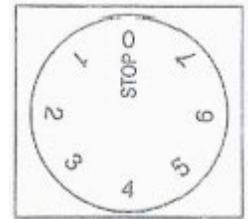



Digital Thermostat (standard on SBC682/3, WBC/BC3, LBC/BC series)



ON/OFF Power

To turn the appliance on or off, press and hold the ON/OFF button for 3 seconds.

Setting the temperature Control

- Adjustable temperature: 1°C to 20°C (34°F to 68°F)
- Set the desired cooling temperature by pressing the corresponding button  or . Each depression of the buttons will raise or lower the temperature setting by 1 degree. The temperature selected will flash in the LED display for approximately 5 seconds, then revert to displaying the temperature of the cabinet interior.

°C/°F

This unit has the option of displaying temperatures in either Celsius or Fahrenheit. To change the setting, press the °C/°F button.

Digital Thermostat (standard on FFAR25L7 and FF31L7 series)

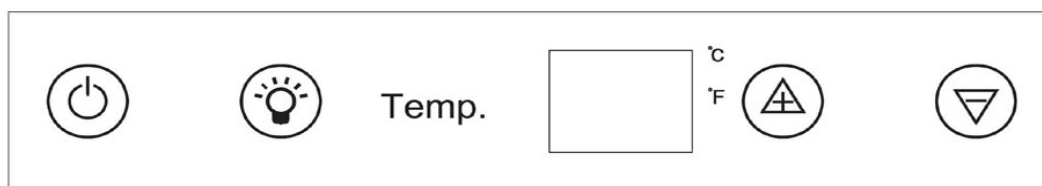

ON/OFF POWER

To turn the appliance ON or OFF, press the  button/mark and hold for 3 seconds.

LIGHT

To turn the inner light ON and OFF.

UP

Used to raise (warm) the set temperature by 1°F/°C.

DOWN

Used to lower (cool) the set temperature by 1°F/°C.

°F/°C Selector

Choose to display temperature setting in Fahrenheit or Celsius. To change the temperature from Fahrenheit to Celsius or from Celsius to Fahrenheit, press the  button for at least 5 seconds.

Setting the Temperature Control

- You can set the temperature by pressing the **UP** and **DOWN** buttons. When you press either of the two buttons for the first time, the LED readout will show the original temperature set previously. (The temperature preset at the factory is 38°F, or 3°C.)
- The temperature you are setting will increase by one degree each time you press the **UP**
- button and will decrease by one degree each time you press the **DOWN** button.
- The range of the temperature control is from 34°F to 43°F.
- To view the set temperature at any time, press the **UP** or **DOWN** button. The set temperature will flash in the display window for 5 seconds. After 5 seconds, the temperature inside the unit will reappear in blue in the display window.

Note: Beer that is left in the unrefrigerated beer line (between the kegerator and the tower) will likely become warm and foamy after a long period of time between service. For the best result pour and discard the first glass of beer at the beginning of service.

Defrosting Your Appliance:

This appliance operates with an automatic defrost system, so the unit defrosts itself. While the compressor is operating, ice will build up along the cold rear wall (the evaporator plate is behind the wall). During the compressor's off-cycle, ice will melt, drip down, collect in the trough at the bottom, and drain through a small hole into a tray above the compressor, where the compressor's heat will evaporate the water. If you notice excessive ice build-up on the rear wall, try adjusting the thermostat to a slightly warmer setting. Be sure that the door gasket is sealing well and that there is no obstruction of the drain hole at the bottom rear of the interior cabinet.

Care and Maintenance

Cleaning Your Appliance:

1. Unplug the appliance, turn the thermostat to **STOP (0)**, and remove all contents, including shelves and crisper.
2. Wash the inside surfaces with a solution of lukewarm water and vinegar. Wipe dry with a clean, soft cloth.
3. Wash the shelves and crisper with a mild detergent solution, then rinse and dry thoroughly.
4. Wash the outside cabinet with a solution of warm water and mild liquid detergent. Rinse well and wipe dry with a clean, soft cloth.
5. Wring excess water out of the sponge or cloth before cleaning the area of the temperature control or any electrical parts.
6. From time to time, wipe the condenser on the back wall with a soft non-metallic brush or vacuum cleaner.
7. After you have cleaned the appliance, reconnect it to the power supply, reset the thermostat and return all contents to their place.

CAUTION: Failure to unplug the unit before cleaning or maintenance could result in electrical shock or personal injury.

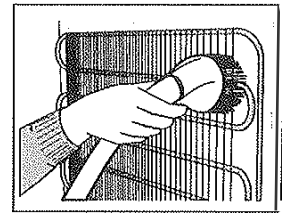

Cleaning Your Floating Tap:

NOTE: Do not use lye, soap, or hot water.

1. Mix one half gallon of warm water and 2 tablespoons of cleaner in a clean bucket.
2. Remove the bottle cleaner cap assembly, fill the jar and reassemble leaving the balance of the solution in the bucket.
3. Turn off the air cock on the regulator or turn off the valve on the CO₂ tank.
4. Disconnect tap from beer barrel. Disconnect the beer faucet from the Draft tower using supplied faucet wrench.
5. Place beer hose and tap into bucket and to allow cleaning solution to run through the beer line. If the tap has a shutoff, place it in the open position. Insert ball lifter into the bottom of the tap to hold check valve in the open position during cleaning.
6. Connect the cleaning jar fitting to the draft tower making sure that the fitting washer is in place. Hold the cleaning jar upside down until the solution runs through the bucket.
7. Fill the jar with cool water and repeat the process until clear water flows into the bucket.
8. Rinse Tap in bucket of cool water and using faucet brush clean the faucet.
9. Remove cleaning jar fitting from tower and reattach faucet making sure that the faucet washer is still in place on the back of the faucet.
10. Reattach the tap to the barrel.

Emptying Beer Line:

Residual beer left in the tap line for over an hour may become foamy. When done serving, we recommend emptying the beer line.

1. Shut off the CO₂ tank valve.
2. Close the coupler.
3. Disconnect the beer line hose from the coupler.
4. Place the beer line hose inside a receptacle large enough to hold an ounce of liquid.
5. Open the faucet to allow air to pass through the hose and empty the remaining liquids.

Visit <https://www.summitappliance.com/floating-tap> for video instructions.

Power Failure:

Most power failures are corrected within a few hours and should not affect the temperature of your appliance if you minimize the number of times the door is opened. If the power is going to be off for a longer period of time, you need to take the proper steps to protect your chilled items.

Vacations:

During long absences, remove all contents. Unplug the appliance, clean it, and leave the door open slightly to avoid possible formation of condensation, mold, or odors.

Moving Your Appliance:

1. Remove the contents.
2. Securely tape down all shelving inside the unit.
3. Turn the leveling legs up to the base to avoid damage.
4. Tape the door shut.
5. Be sure the appliance stays secure in the upright position during transportation.

Energy-Saving Tips:

- The unit should be in the coolest area of the room, away from heat-producing appliances or heating ducts, and out of direct sunlight.
- Try not to open the door too often, especially when the weather is damp and hot. Once you open the door, close it as soon as possible.
- Occasionally check if the appliance is sufficiently ventilated (adequate air circulation behind the appliance).
- Set the thermostat from higher to lower settings as soon as possible (depending on how loaded the appliance is, ambient temperature, etc.).
- Before loading items into the unit, be sure they have cooled to ambient temperature.

Draft Beer Troubleshooting

When using this appliance, you may come across some problems that in many cases result from improper handling and can easily be eliminated.

Problem	Cause	Correction
Beer is cloudy: The beer in the glass appears hazy and not clear.	Excessively low temperatures may cause hazy or cloudy beer, particularly when the beer lies in the cold coil for long periods of time.	Drain a few ounces before drinking.
		Raise the temperature setting of the unit.
	Glasses may not have been cleaned properly.	Do not wash beer glasses together with glasses that contain milk or any other fatty substance. An excessive amount of germicide build-up may also leave a fatty film, which will cause the beer to go flat.
		It is preferable to steam and sterilize glasses where health laws permit.
		Wash glasses thoroughly with a good detergent to remove all fatty substances (e.g., lipstick).
		Do not use soap.
		Do not wipe the glasses dry. Permit glasses to air-dry by placing them on a wire rack or corrugated metal sheet.
Rinse the glasses in fresh cold water just before serving beer. It is best to serve beer in a wet glass.		
Improper drawing of beer into glass	Open the faucet quickly and completely; proper foam should be a tight creamy head. The collar on the average glass should be ¾" to 1" high. Beer drawn without a head has the appearance of being flat.	
	Not enough pressure	Increase the pressure if the beer runs too slowly. The correct flow should fill a 10-oz glass in 4 seconds (approx. 8 oz of liquid). Check the pressure source to determine whether there are obstructions in the airline. Replace a sluggish air source or the CO ₂ regulator and gauge. The tank pressure must always be higher than the pressure used on the keg. Always apply pressure to the keg before drawing beer.
The beer comes out warm and foamy.	The beer is too warm	Adjust the temperature in the unit to make the beer colder.
	Wrong CO ₂ pressure	If the pressure is too high, the beer will come out foamy. Keep the pressure range between 10-12 PSI.
	Dirty or damaged beer line	The beer line needs to either be cleaned or replaced.
	Probe washer is missing or damaged	If the probe washer is damaged or missing, the beer will come out foamy every time. Replace it as soon as possible.
	Too much time between service	Pour and discard the first cup of beer at the beginning of service to refresh the beer line.

General Troubleshooting

Problem	Cause	Correction
The appliance fails to operate after connecting it to the power source.	Power supply is inactive.	Check whether the power supply is active.
	Thermostat is set to STOP (0)	Adjust the thermostat setting on the dial.
The compressor is running continuously.	The door is opened frequently, or it was left open too long.	Keep door closed when it is not in use.
	The door is not properly closed or sagging.	Adjust the door. Clean or replace gasket.
	The power supply has been interrupted for a long period of time.	Check the power supply. If outdoor: Check GFCI cord.
	The appliance may have been overloaded with items above room temperature.	Allow items to reach room temperature before adding them to the appliance.
	There may be inadequate ventilation of the compressor and condenser.	Assure there is adequate air circulation behind the appliance and wipe the dust from the condenser.
Noise	<p>Cooling in refrigeration appliances is enabled by the refrigerating system with a compressor. Noise can depend on where the appliance is placed, how it is used, and how old it is.</p> <p>During the operation of the compressor, the noise of liquid is heard and when the compressor is not operating, the refrigerant flow is heard. This is a normal condition and has no influence whatsoever on the lifetime of the appliance.</p> <p>After starting the appliance, the operation of the compressor and the refrigerant flow may be louder. This does not mean that something is wrong. The noise will gradually reduce.</p> <p>Sometimes a louder noise is heard, which is unusual for the appliance. This noise is often a consequence of improper placement of the unit.</p>	The unit should be placed and leveled firmly on a solid base, and it should not touch the wall or cabinets standing next to it.

If you have checked the tables above and find that you still need help with your appliance, call our Customer Service facility at **800-932-4267 (Ext. 513)** between 9:00 AM and 5:00 PM ET or visit www.summitappliance.com/support at any time. We will do our best to answer your questions.

CALIFORNIA CARB/SNAP DISCLOSURE

This product uses eco-friendly hydrocarbon refrigerant and fully complies with California CARB regulations.

However, we are required by California Law to provide the following disclosure statement in every product sold in California.

"This equipment is prohibited from use in California with any refrigerants on the 'List of Prohibited Substances' for that specific end-use, in accordance with California Code of Regulations, title 17, section 95374. This disclosure statement has been reviewed and approved by Felix Storch, Inc. and Felix Storch, Inc. attests, under penalty of perjury, that these statements are true and accurate."

This product does **not** use any refrigerants on the 'List of Prohibited Substances'"

Notes

Limited Warranty

ONE-YEAR LIMITED WARRANTY

Within the 48 contiguous United States, for one year from the date of purchase, when this appliance is operated and maintained according to instructions attached to or furnished with the product, warrantor will pay for factory-specified parts and repair labor to correct defects in materials or workmanship. Service must be provided by a designated service company. Outside the 48 states, all parts are warranted for one year from manufacturing defects. Plastic parts, shelves and cabinets are warranted to be manufactured to commercially acceptable standards and are not covered from damage during handling or breakage.

5-YEAR COMPRESSOR WARRANTY

1. The compressor is covered for 5 years.
2. Replacement does not include labor.

ITEMS WARRANTOR WILL NOT PAY FOR:

1. Service calls to correct the installation of your appliance, to instruct you how to use your appliance, to replace or repair fuses or to correct wiring or plumbing.
2. Service calls to repair or replace appliance light bulbs or broken shelves. Consumable parts (such as filters) are excluded from warranty coverage.
3. Damage resulting from accident, alteration, misuse, abuse, fire, flood, acts of God, improper installation, installation not in accordance with electrical or plumbing codes, or use of products not approved by warrantor.
4. Replacement parts or repair labor costs for units operated outside the United States.
5. Repairs to parts or systems resulting from unauthorized modifications made to the appliance.
6. The removal and reinstallation of your appliance if it is installed in an inaccessible location or is not installed in accordance with published installation instructions.

DISCLAIMER OF IMPLIED WARRANTIES – LIMITATION OF REMEDIES

CUSTOMER'S SOLE AND EXCLUSIVE REMEDY UNDER THIS LIMITED WARRANTY SHALL BE PRODUCT REPAIR AS PROVIDED HEREIN. IMPLIED WARRANTIES, INCLUDING WARRANTIES OF MERCHANTABILITY OR FITNESS FOR A PARTICULAR PURPOSE, ARE LIMITED TO ONE YEAR. WARRANTOR SHALL NOT BE LIABLE FOR INCIDENTAL OR CONSEQUENTIAL DAMAGES. SOME STATES DO NOT ALLOW THE EXCLUSION OR LIMITATION OF INCIDENTAL OR CONSEQUENTIAL DAMAGES, OR LIMITATIONS ON THE DURATION OF IMPLIED WARRANTIES OF MERCHANTABILITY OR FITNESS, SO THESE EXCLUSIONS OR LIMITATIONS MAY NOT APPLY TO YOU. THIS WARRANTY GIVES YOU SPECIFIC LEGAL RIGHTS AND YOU MAY ALSO HAVE OTHER RIGHTS, WHICH VARY FROM STATE TO STATE.



WARNING: This product can expose you to chemicals including Nickel (Metallic) which is known to the State of California to cause cancer.

For more information go to www.P65Warnings.ca.gov

Note: Nickel is a component in all stainless steel and some other metallic compositions.

FELIX STORCH, INC.
770 Garrison Avenue
Bronx, NY 10474
Phone: (718) 893-3900
Fax: (844) 478-8799
www.summitappliance.com

SUMMIT
APPLIANCE

For parts and accessory ordering,
troubleshooting and helpful hints, visit:
www.summitappliance.com/support