

3'-6" LG. ELEC. CORD
120V-60HZ

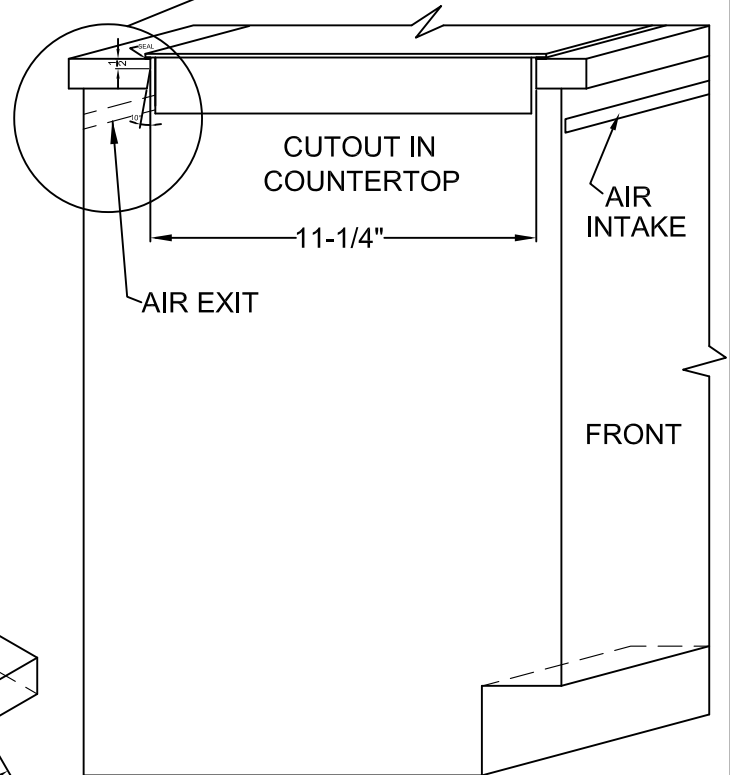
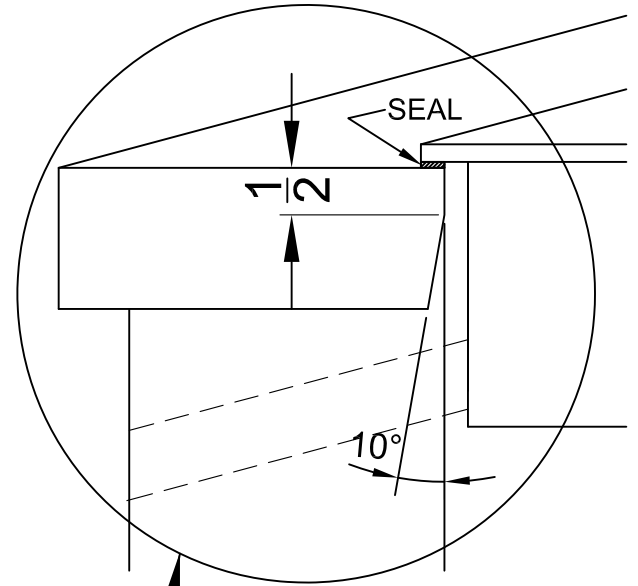
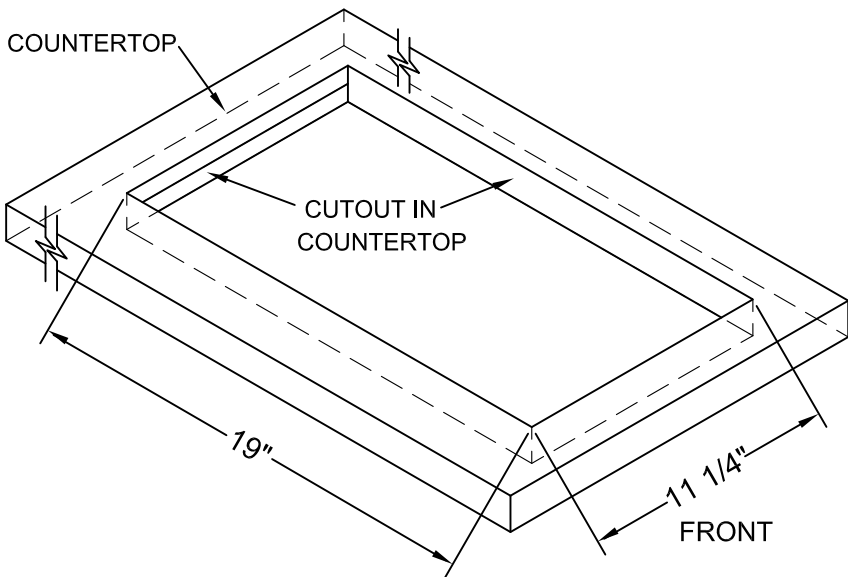
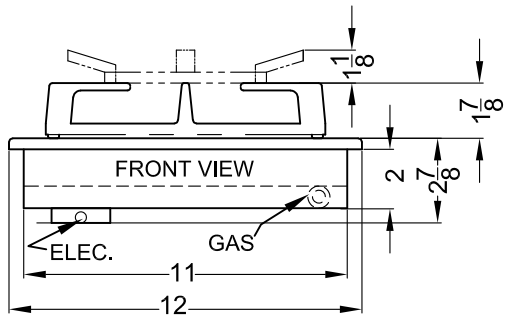
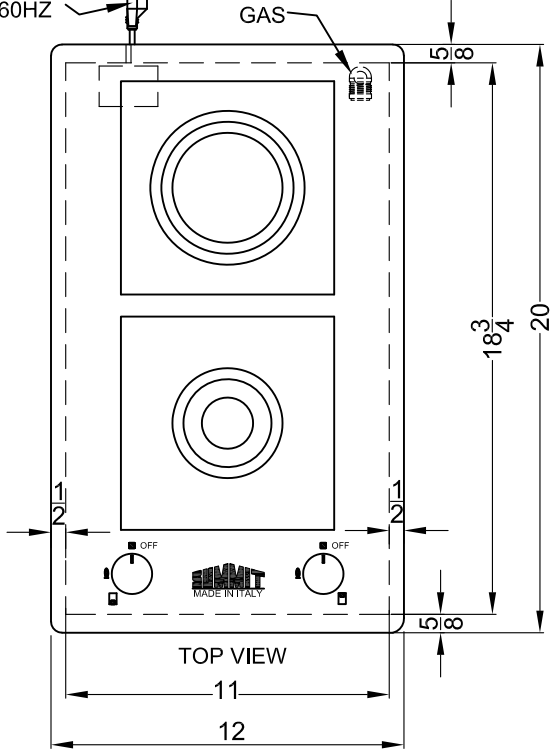

MODEL: GCJ2SS

TYPE:
(2) BURNER GAS COOKTOP

SUMMIT

FELIX STORCH, INC.
www.summitappliance.com

718-893-3900

CUTOUT IN COUNTER TOP

DATE: DEC./13/2019