

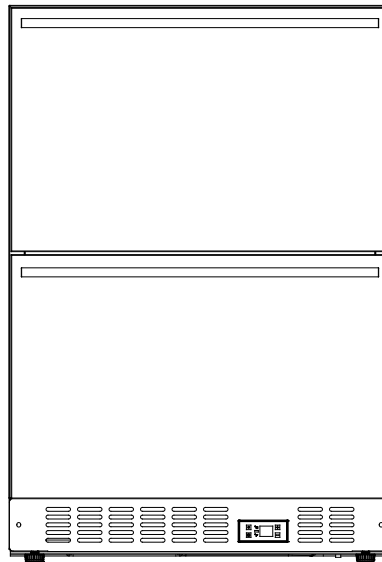

FROST-FREE DRAWER REFRIGERATOR and DRAWER FREEZER

Model Nos. FF642D / SCFF532D



INSTRUCTION MANUAL

BEFORE USE, PLEASE READ AND FOLLOW ALL SAFETY RULES AND OPERATING INSTRUCTIONS.

*Write Serial No. (on lower left corner of
inside cabinet) here:*

**Felix Storch, Inc.
770 Garrison Avenue
Bronx, NY 10474
www.summitappliance.com**

TABLE OF CONTENTS

Appliance Safety	3
Important Safeguards	3 - 4
Location of Parts	5
Installation Instructions	6 - 8
Before Using Your Appliance	6
Installation of Your Appliance	6
Electrical Connection	6 - 7
Extension Cord	7
Anti-Tip Bracket Installation	7
Installing the Stainless Steel Handles	8
Operating Your Appliance	9 - 12
Control Panel for FF642D	9 - 10
Control Panel for SCFF532D	10
Sabbath Mode	11
Temperature Memory Function	11
Defrosting	11
Using the Freezer SCFF532D	11
Temperature Alarm / Door Alarm	12
Care and Maintenance	13
Cleaning Your Appliance	13
Power Failure	13
Vacation Time	13
Moving Your Appliance	13
Energy-Saving Tips	13
Troubleshooting	14 - 15
Limited Warranty	16

APPLIANCE SAFETY

Your safety and the safety of others are very important.

We have provided many important safety messages in this manual and on your appliance. Always read and obey all safety messages.



This is the Safety Alert Symbol. The symbol alerts you to potential hazards that can kill or injure you and others. All safety messages will follow the Safety Alert Symbol and either the word DANGER or WARNING.



DANGER means that failure to heed this safety statement may result in severe personal injury or death.



WARNING means that failure to heed this safety statement may result in extensive product damage, serious personal injury, or death.

All safety messages will alert you about the potential hazard, tell you how to reduce the chance of injury, and let you know what can happen if the instructions are not followed.

IMPORTANT SAFEGUARDS



Before the appliance is used, it must be properly positioned and installed as described in this manual, so read the manual carefully. To reduce the risk of fire, electrical shock or injury when using the appliance, follow basic precautions, including the following:



- Plug into a grounded 3-prong outlet, do not remove grounding prong, do not use an adapter, and do not use an extension cord.
- Replace all panels before operating.
- It is recommended that a separate circuit serving only your appliance be provided. Use receptacles that cannot be turned off by a switch or pull chain.
- Never clean appliance parts with flammable fluids. These fumes can create a fire hazard or explosion. And do not store or use gasoline or other flammable vapors and liquids in the vicinity of this or any other appliance. The fumes can create a fire hazard or explosion.
- Do not connect or disconnect the electric plug when your hands are wet.
- Unplug the appliance or disconnect power before cleaning or servicing. Failure to do so can result in electrical shock or death.
- Do not attempt to repair or replace any part of your appliance unless it is specifically recommended in this manual. All other servicing should be referred to a qualified technician.
- This appliance is CFC- and HFC-free and contains small quantities of Isobutane (R600a) which is environmentally friendly, but flammable. It does not damage the ozone layer, nor does it increase the greenhouse effect. Care must be taken during transportation and setting up of the appliance that no parts of the cooling system are damaged. Leaking coolant can ignite and may damage the eyes. In the event of any damage:

- Avoid open flames and anything that creates a spark,
- Disconnect from the power source,
- Air the room in which the appliance is located for several minutes and
- Contact the Service Department for advice.
- The more coolant there is in an appliance, the larger the room in which it should be installed. In the event of a leakage, if the appliance is in a small room, there is the danger of combustible gases building up. For every ounce of coolant, at least 325 cubic feet of room space is required. The amount of coolant in the appliance is stated on the data plate inside the appliance. It is hazardous for anyone other than an Authorized Service Person to carry out servicing or repairs to this appliance.
- Take serious care when handling, moving, and using the appliance to avoid either damaging the refrigerant tubing or increasing the risk of a leak.
- Replacing component parts and servicing shall be done by factory authorized service personnel, so as to minimize the risk of possible ignition due to incorrect parts or improper service.

WARNING

FOLLOW WARNING CALLOUTS BELOW ONLY WHEN APPLICABLE TO YOUR MODEL

- Use two or more people to move and install appliance. Failure to do so can result in back or other injury.
- To ensure proper ventilation for your appliance, the front of the unit must be completely unobstructed. Choose a well-ventilated area with temperatures above 44°F (7°C) and below 95°F (35°C).
- The appliance should not be located next to ovens, grills or other sources of high heat.
- The appliance must be installed with all electrical, water and drain connections in accordance with state and local codes. A standard electrical supply (115 V AC only, 60 Hz), properly grounded in accordance with the National Electrical Code and local codes and ordinances, is required.
- Do not kink or pinch the power supply cord of the appliance.
- The size of the fuse (or circuit breaker) should be 15 amperes.
- It is important that the appliance be leveled in order to work properly. You may need to make several adjustments to level it.
- All installations must be in accordance with local plumbing code requirements.
- Make certain that the pipes are not pinched, kinked or damaged during installation.
- Check for leaks after connection.
- Never allow children to operate, play with or crawl inside the appliance.
- Do not use solvent-based cleaning agents or abrasives on the interior. These cleaners may damage or discolor the interior.
- Use this appliance only for its intended purpose as described in this *Instruction Manual*.
- Keep fingers out of the “pinch point” areas. Clearances between the drawers and cabinet are necessarily small. Be careful closing drawers when children are in the area.

DANGER

Risk of child entrapment!

Child entrapment and suffocation are not problems of the past. Junked or abandoned appliances are still dangerous, even if they will “just sit for a few days”.

Before discarding your old appliance:

- *Take off the doors*
- *Leave the shelves in place so that children may not easily climb inside.*

- SAVE THESE INSTRUCTIONS -

LOCATION OF PARTS

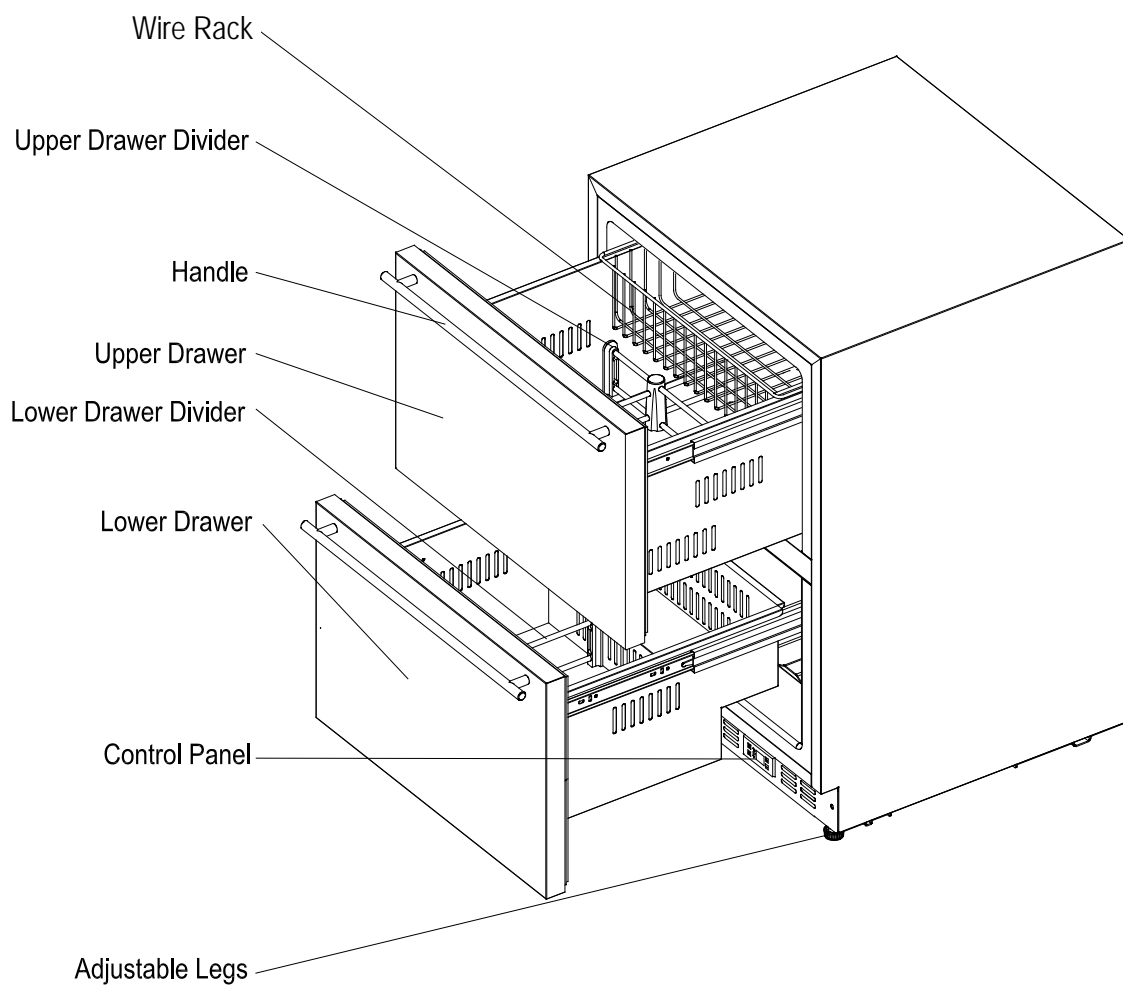

INSTALLATION INSTRUCTIONS

BEFORE USING YOUR APPLIANCE

- Remove the exterior and interior packing.
- Before connecting the appliance to the power source, let it stand upright for approximately 2 hours. This will reduce the possibility of a malfunction in the cooling system from handling during transportation.
- Clean the interior surface with lukewarm water using a soft cloth.
- Install the handles on the drawers, if they are not already attached. (See page 8.)

INSTALLATION OF YOUR APPLIANCE

- The appliance is designed for built-in or recessed or free-standing installation and for indoor only.
- **CAUTION:** This appliance is not designed for the storage of medicine or other medical products.
- Place your appliance on a floor that is strong enough to support it when it is fully loaded. To level the unit, adjust the front leveling legs.
- For free-standing installation, 5" (127mm) of space between the back and sides of the unit, and 4" (102mm) at the top, are suggested. This allows the proper air circulation to cool the compressor and condenser. Even for built-in installation, it is a must to keep ¼" (6.35mm) space on each side and at the top and 2" (51mm) at the rear. Take care that the air vent at the front of the appliance is never covered or blocked in any way.
- **NOTE:** It is recommended that you do not install the appliance near an oven, radiator or other heating source. Direct sunlight may affect the outer coating and heat sources may increase electrical consumption. Don't install in a location where the temperature will fall below 44°F (7°C). For best performance, do not install the appliance behind a cabinet door or block the base grille.
- Avoid locating the unit in moist areas.
- Plug the appliance into an exclusive, properly grounded wall outlet.

ELECTRICAL CONNECTION



WARNING

Improper use of the grounded plug can result in the risk of electrical shock. If the power cord is damaged, have it replaced by a qualified electrician or an authorized service center.

This appliance should be properly grounded for your safety. The power cord of this appliance is equipped with a three-prong plug which mates with standard three-prong wall outlets to minimize the possibility of electrical shock.

Do not under any circumstances cut or remove the third (ground) prong from the power cord supplied. For personal safety, this appliance must be properly grounded. Any questions concerning power and/or grounding should be directed toward a certified electrician or an authorized service center.

This appliance requires a standard 115/120 Volt AC ~ 60Hz three-prong grounded electrical outlet. Have the wall outlet and circuit checked by a qualified electrician to make sure the outlet is properly grounded. When a standard 2-prong wall outlet is encountered, it is your responsibility and obligation to have it replaced with a properly grounded 3-prong wall outlet.

To prevent accidental injury, the cord should be secured behind the appliance and not left exposed or dangling.

The appliance should always be plugged into its own individual electrical outlet which has a voltage rating that matches the rating label on the appliance. This provides the best performance and also prevents overloading house wiring circuits that could cause a fire hazard from overheating. Never unplug the appliance by pulling on the power cord. Always grip the plug firmly and pull straight out from the receptacle. Repair or replace immediately all power cords that have become frayed or otherwise damaged. Do not use a cord that shows cracks or abrasion damage along its length or at either end. When moving the appliance, be careful not to damage the power cord.

EXTENSION CORD

Because of potential safety hazards under certain conditions, it is strongly recommended that you do not use an extension cord with this appliance. However, if you must use an extension cord, it is absolutely necessary that it be a UL/CUL-Listed, 3-wire grounding type appliance extension cord having a grounding type plug and outlet and that the electrical rating of the cord be 115 volts and at least 10 amperes.

ANTI-TIP BRACKET INSTALLATION

To reduce the risk of tipping the unit by abnormal usage or improper loading, the appliance must be secured by properly installing the anti-tip device packed with the appliance.

- Place the anti-tip bracket on the floor as shown in the figure. An anti-tip bracket can be installed on either right or left side.
- Mark the locations of the 4 holes of the anti-tip bracket on the floor.
- Use a 5/16" masonry drill bit and insert plastic anchors.
- Secure bracket to floor using screws.
- Slide appliance into position and make sure the leg engages the anti-tip bracket.

NOTE: If the unit is relocated, the bracket must be removed and installed in the new location.

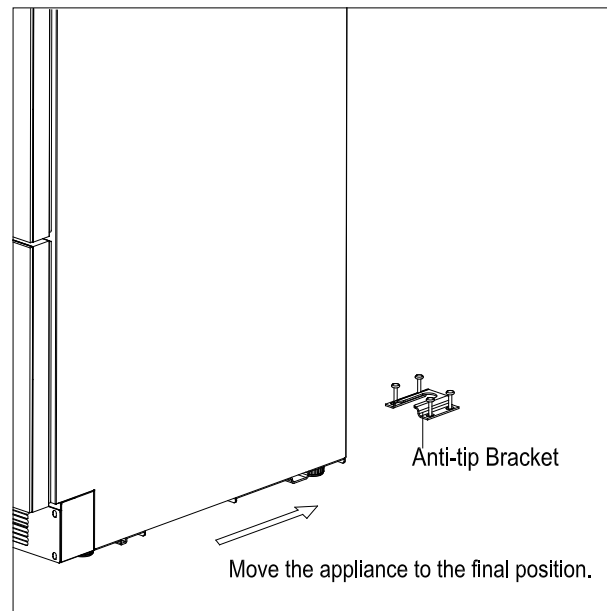
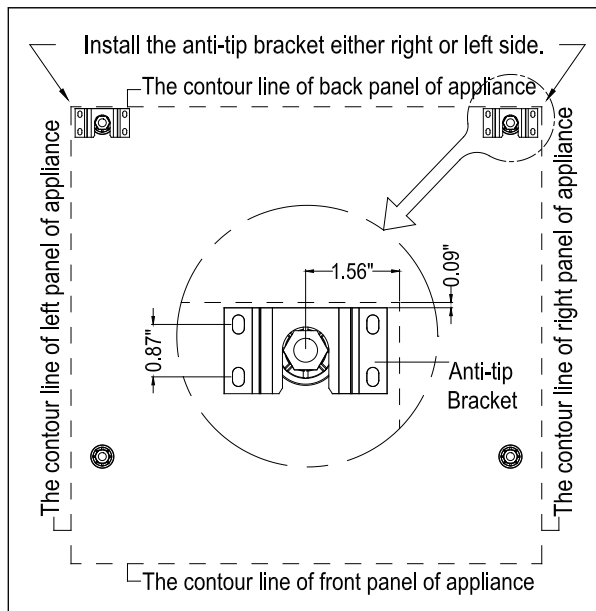

INSTALLING THE STAINLESS STEEL HANDLES

This appliance includes two stainless steel handles that are not required to operate the unit. To install the handles, follow the instructions below:

1. Remove the door gasket.
2. Install the handle with the screws provided. (DO NOT over-tighten as this will cause damage to the stainless steel door surface.)
3. Replace the door gasket.

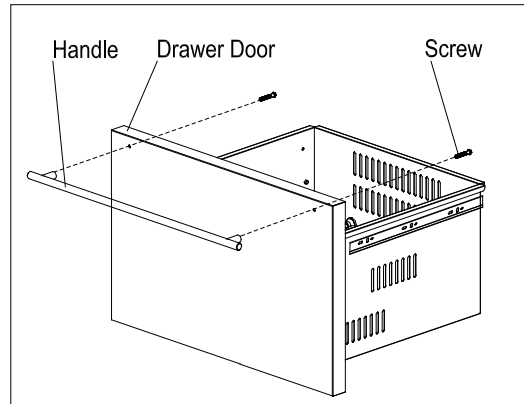

OPERATING YOUR APPLIANCE

It is recommended you install the appliance in a place where the ambient temperature is between 44° and 95°F (7° - 35°C). If the ambient temperature is above or below the recommended temperatures, the performance of the unit may be affected. For example, placing your unit in extremely cold or hot conditions may cause interior temperatures to fluctuate. The expected operating temperature range may not be reached.

CONTROL PANEL for FF642D



ON/OFF Power

To turn the appliance ON or OFF, touch the  symbol and hold for 5 seconds.

NOTE: Pressing the POWER key once can switch off the audible alarm when the alarm is on.

UP

Used to increase (warm) the set temperature by 1°C/1°F.

DOWN

Used to decrease (cool) the set temperature by 1°C/1°F.

°F/°C Selector

Select the temperature display in Fahrenheit or Celsius degrees. To change the temperature from Fahrenheit to Celsius or from Celsius to Fahrenheit, press and hold the **LIGHT** key for 5 seconds.

Setting the Temperature Control

- You can set the temperature by touching the **UP** and **DOWN** symbols. When you push either of the two buttons for the first time, the LED readout will show the original temperature set previously. (The temperature preset at the factory is 38°F or 3°C.)
- The temperature you are setting will increase by one degree each time you touch the **UP** symbol, and will decrease by one degree each time you touch the **DOWN** symbol.
- The range of the temperature control is from 36°F to 43°F.
- To view the set temperature at any time, touch the **UP** or **DOWN** symbol. The set temperature will flash in the display window for 5 seconds. After 5 seconds, the temperature inside the unit will reappear in the display window.

Interior Light

- The interior light makes it easy to view your items. Touching the LIGHT symbol toggles between 2 modes of operation for the internal lights: functional (default) mode and showcase mode. If

you are in functional (default) mode, the lights will turn on only when a drawer is open. If you are in showcase mode, the lights will be on whether or not the drawer is open.

CONTROL PANEL for SCFF532D

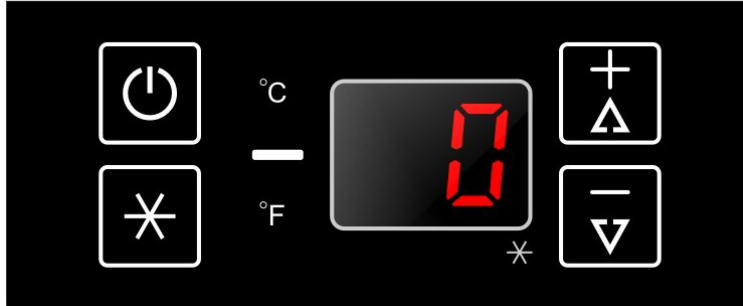

ON/OFF Power

To turn the appliance ON or OFF, press and hold the POWER key  for 5 seconds.

NOTE: Pressing the POWER key once can switch off the audible alarm when the alarm is on.

SuperFreeze

SuperFreeze is used to freeze fresh food quickly. The function overrides the thermostat control and will make the compressor operate continuously. It is not necessary to adjust the thermostat setting when using this function. When the function is selected, the SuperFreeze indicator will be ON. The function can be exited by pressing the key again and the indicator will turn OFF. SuperFreeze will turn off automatically after 8 hours.

UP

Used to increase (warm) the set temperature by 1°C/1°F.

DOWN

Used to decrease (cool) the set temperature by 1°C/1°F.

°F/°C Selector

Select the temperature display setting in Fahrenheit or Celsius degree. To change the temperature from Fahrenheit to Celsius or from Celsius to Fahrenheit, press and hold the **SUPERFREEZE** key for 5 seconds.

Setting the Temperature Control

- You can set the temperature by pressing the **UP** and **DOWN** keys. When you press either of the two keys for the first time, the LED readout will show the original temperature set previously. (The temperature preset at the factory is 0°F or -18°C.)
- The temperature you are setting will increase by one degree each time you press the **UP** key, and will decrease by one degree each time you press the **DOWN** key.
- The range of the temperature control is from -11°F to 11°F.
- To view the set temperature at any time, press the **UP** or **DOWN** key. The set temperature will flash in the display window for 5 seconds. After 5 seconds, the temperature inside the unit will reappear in the display window.

Interior Light

The unit is equipped with an interior LED light which will be turned ON when a drawer is open.

NOTE:

- If the unit is unplugged or power is lost or turned off, you must wait 3 to 5 minutes before restarting the unit. If you attempt to restart before this time delay, the unit will not start.
- When you use the unit for the first time or restart the unit after it has been shut off for a long time, there could be a few degrees variance between the temperature you select and the one indicated on the LED readout. This is normal and is due to the length of the activation time. There should not be a problem once the unit has been running for a few hours.

SABBATH MODE

Sabbath mode is available for the observance of certain religious holidays. This mode turns off the displays, interior light and audible alarms and prevents them from turning on again. Normal cooling operations will still take place.

To initiate Sabbath mode, press the **POWER** and **LIGHT** keys at the same time for at least 5 seconds for FF642D or press the **POWER** and **SUPERFREEZE** keys at the same time for at least 5 seconds for SCFF532D. The indicator light will flash four times and confirm the Sabbath mode is ON.

Sabbath mode can be exited by repeating the above process. The Sabbath Mode will automatically turn off after 96 hours.

TEMPERATURE MEMORY FUNCTION

- In the event of a power interruption (power surge, breaker switch, etc.), the unit can remember the previous temperature settings, and when power is recovered, the cabinet temperature will return to the same set temperature as before the power went off.

DEFROSTING

- Under normal operating conditions, the unit requires no manual defrosting.
- The evaporator behind the rear wall of the unit defrosts automatically. The condensate collects in the drainage channel behind the rear wall of the unit and flows through the drainage hole into the drip tray by the compressor where it evaporates.
- However, frost may accumulate on the evaporator if the unit is repeatedly opened in high heat or high humidity locations. If this frost pattern does not clear within 24 hours, your unit will require manual defrosting.

USING THE FREEZER SCFF532D

- This unit is designed for the long-term storage of frozen food. Storage time is up to three months.
- The storage life of frozen foods varies and the recommended storage time should not be exceeded.
- Pre-packed commercially frozen food should be stored in accordance with the frozen foods manufacturer's instructions for a three-star frozen food storage compartment or home freezer.
- Place frozen food into the freezer as quickly as possible after purchase. If there are instructions on the packet, carefully follow these instructions regarding storage times.

TEMPERATURE ALARM / DOOR ALARM

- An audible alarm sounds if the storage temperature is not cold enough. The temperature display flashes at the same time.
- The cause of the temperature being too high may be:
 - Warm fresh food was placed inside
 - Too much warm ambient air flowed in when rearranging and removing food
 - Power failure for some time
 - The appliance is faulty
- The audible alarm is automatically silenced and the temperature display stops flashing when the temperature is sufficiently cold again.
- If a drawer has been left open for more than 60 seconds, the alarm will sound. Pressing the POWER key once can switch off the audible alarm.

CARE AND MAINTENANCE

CLEANING YOUR APPLIANCE

- Turn off the power, unplug the appliance, and remove all items, including racks and dividers.
- Wash the inside surfaces with a solution of warm water and baking soda (about 2 tablespoons of baking soda to a quart of water).
- Wash the racks and dividers with a mild detergent solution.
- Wring excess water out of the sponge or cloth when cleaning the area where the controls are located, or any electrical parts.
- Wash the outside cabinet with warm water and mild liquid detergent. Rinse well and wipe dry with a clean soft cloth.
- Use an approved stainless steel cleaner to clean the doors and handles. Do not use steel wool or a steel brush on the stainless steel.

CAUTION:

Failure to unplug the appliance before cleaning could result in electrical shock or other personal injury.

POWER FAILURE

Most power failures are corrected within a few hours and should not affect the temperature of your appliance if you minimize the number of times the drawers are opened. If the power is going to be off for a longer period of time, you need to take the proper steps to protect the contents.

VACATION TIME

- **Short vacations:** Leave the appliance operating during vacations of less than three weeks.
- **Long vacations:** If the appliance will not be used for several months, remove all items and turn off the appliance. Clean and dry the interior thoroughly. To prevent odor and mold growth, leave the drawers open slightly, blocking them open if necessary.

MOVING YOUR APPLIANCE

1. Remove all items.
2. Securely tape down all loose items (racks, dividers) inside your appliance.
3. Turn the adjustable legs up to the base to avoid damage.
4. Tape the drawers shut.
5. Be sure the appliance stays secure in the upright position during transportation. Also, protect the outside of the appliance with a blanket or similar item.

ENERGY-SAVING TIPS

- The appliance should be located in the coolest area of the room, away from heat-producing appliances and out of direct sunlight.
- Ensure that the unit is adequately ventilated. Never cover air vents.
- Do not keep the drawers open any longer than necessary.
- Let hot foods cool to room temperature before placing in the unit. Overloading the unit forces the compressor to run longer.
- Be sure to wrap foods properly, and wipe containers dry before placing them in the unit. This cuts down on frost build-up inside the unit.
- Unit bins and racks should not be lined with aluminum foil, wax paper, or paper toweling. Liners interfere with cold air circulation, making the unit less efficient.
- Organize and label food to reduce drawer openings and extended searches. Remove as many items as needed at one time, and close the drawer as soon as possible.

TROUBLESHOOTING

You can solve many common problems easily, saving you the cost of a possible service call. Try the suggestions below to see if you can solve the problem before calling the servicer.

Troubleshooting Guide

PROBLEM	POSSIBLE CAUSE	REMEDY
Appliance does not operate.	<ul style="list-style-type: none"> • Appliance is not connected to a power supply. • The appliance is turned off. • Tripped circuit breaker or blown fuse 	<ul style="list-style-type: none"> • Connect the appliance. • Switch on the appliance. • Switch on circuit breaker or replace fuse.
Appliance is not cold enough.	<ul style="list-style-type: none"> • The temperature is not set correctly. • The ambient temperature could require a lower temperature setting. • Drawers were opened too often. • A drawer was not closed completely. • Drawer is not hermetically sealed. • The condenser is too dirty. • The ventilation opening is blocked or too dusty. 	<ul style="list-style-type: none"> • Check the set temperature. • Set a lower temperature. • Do not open drawers more often than necessary. • Close drawer properly. • Check the seal and clean or replace. • Clean the condenser when necessary. • Clear the obstructions and clean off the dust.
Appliance turns itself on and off frequently.	<ul style="list-style-type: none"> • The room temperature is higher than average. • A large amount of food has been added to the unit. • Drawers are opened too often. • A drawer is not closed completely. • A drawer gasket does not seal properly. 	<ul style="list-style-type: none"> • Put the appliance in a cooler place. • Leave the appliance to work for a while until the set temperature has been reached. • Do not open the drawers more often than necessary. • Close drawer properly. • Check the drawer seal and clean or replace it.
The light does not work.	<ul style="list-style-type: none"> • Appliance is not connected to a power supply. • Tripped circuit breaker or a blown fuse. • The light was switched off on the control panel. 	<ul style="list-style-type: none"> • Connect the appliance. • Switch on circuit breaker or replace fuse. • Switch on the light.
Vibrations	<ul style="list-style-type: none"> • The appliance is not properly leveled. 	<ul style="list-style-type: none"> • Level the appliance with the adjustable feet.
The appliance seems to make too much noise.	<p>The rattling noise may come from the flow of the refrigerant, which is normal. As each cycle ends, you may hear gurgling sounds caused by the flow of refrigerant in your appliance. If temperature fluctuations occur, the contraction and expansion of the inner walls may cause popping and crackling noises.</p>	
	<ul style="list-style-type: none"> • The appliance is not properly level. 	<ul style="list-style-type: none"> • Level the appliance with the adjustable feet.
Drawers will not close properly.	<ul style="list-style-type: none"> • The appliance is not properly leveled. • The gaskets are dirty. • The racks or bins are out of position. 	<ul style="list-style-type: none"> • Level the appliance with the adjustable feet. • Clean the drawer gaskets. • Check the racks and bins and refit correctly.

<p>Display “E0”, “E1”, “E2”, “E3”, “E4”, “E5” or “E7”.</p>	<ul style="list-style-type: none"> • “E0” indicates the communication error for 3 zone models. • “E1” or “E2” indicates that the air temperature sensor has failed. • “E3” or “E4” indicates that the defrost sensor in the evaporator has failed. • “E5” indicates defrost heater failure. • “E7” indicates door switch failure. 	<ul style="list-style-type: none"> • Call for service.
<p>The alarm sounds and the temperature display flashes.</p>	<p>Has a drawer been open for longer than 60 seconds? If not, then the temperature has risen higher or fallen lower than the temperature that has been set. This could be due to:</p> <ul style="list-style-type: none"> • The appliance drawers being opened too often. • The ventilation opening being covered or too dusty. • A lengthy interruption in the power supply. • A large amount of food has been added to the unit. 	<p>If yes, close the drawer.</p> <ul style="list-style-type: none"> • Do not open drawers more often than necessary. • Clear the obstructions and clean off the dust. • Leave the appliance to work for a while until the set temperature has been reached.
<p>The icon “--” is lit and flashing in the temperature display.</p>	<ul style="list-style-type: none"> • The display temperature is out of range. 	<ul style="list-style-type: none"> • Only temperatures within the range 0~99°F/-9~37°C for FF642D and the range -49~99°F/-45~37°C for SCFF532D can be displayed. If the temperature is not within this range, the icon “--” will be displayed instead. This is normal.

If you've checked the table above and find that you still need help with your appliance, call our Customer Service facility at **800-932-4267** between 9:00AM and 5:00PM ET. We will do our best to answer your questions.

LIMITED WARRANTY

ONE-YEAR LIMITED WARRANTY

Within the 48 contiguous United States, for one year from the date of purchase, when this appliance is operated and maintained according to instructions attached to or furnished with the product, warrantor will pay for factory-specified parts and repair labor to correct defects in materials or workmanship. Service must be provided by a designated service company. Outside the 48 states, all parts are warranted for one year from manufacturing defects. Plastic parts, shelves and cabinets are warranted to be manufactured to commercially acceptable standards, and are not covered from damage during handling or breakage.

5-YEAR COMPRESSOR WARRANTY

1. The compressor is covered for 5 years.
2. Replacement does not include labor.

ITEMS WARRANTOR WILL NOT PAY FOR:

1. Service calls to correct the installation of your appliance, to instruct you how to use your appliance, to replace or repair fuses or to correct wiring or plumbing.
2. Service calls to repair or replace appliance light bulbs or broken shelves. Consumable parts (such as filters) are excluded from warranty coverage.
3. Damage resulting from accident, alteration, misuse, abuse, fire, flood, acts of God, improper installation, installation not in accordance with electrical or plumbing codes, or use of products not approved by warrantor.
4. Replacement parts or repair labor costs for units operated outside the United States.
5. Repairs to parts or systems resulting from unauthorized modifications made to the appliance.
6. Expenses for travel and transportation for product service in remote locations.
7. The removal and reinstallation of your appliance if it is installed in an inaccessible location or is not installed in accordance with published installation instructions.

DISCLAIMER OF IMPLIED WARRANTIES; LIMITATION OF REMEDIES

CUSTOMER'S SOLE AND EXCLUSIVE REMEDY UNDER THIS LIMITED WARRANTY SHALL BE PRODUCT REPAIR AS PROVIDED HEREIN. IMPLIED WARRANTIES, INCLUDING WARRANTIES OF MERCHANTABILITY OR FITNESS FOR A PARTICULAR PURPOSE, ARE LIMITED TO ONE YEAR. WARRANTOR SHALL NOT BE LIABLE FOR INCIDENTAL OR CONSEQUENTIAL DAMAGES. SOME STATES DO NOT ALLOW THE EXCLUSION OR LIMITATION OF INCIDENTAL OR CONSEQUENTIAL DAMAGES, OR LIMITATIONS ON THE DURATION OF IMPLIED WARRANTIES OF MERCHANTABILITY OR FITNESS, SO THESE EXCLUSIONS OR LIMITATIONS MAY NOT APPLY TO YOU. THIS WARRANTY GIVES YOU SPECIFIC LEGAL RIGHTS AND YOU MAY ALSO HAVE OTHER RIGHTS, WHICH VARY FROM STATE TO STATE.

FELIX STORCH, INC.
770 Garrison Avenue
Bronx, NY 10474
Phone: (718) 893-3900
Fax: (844) 478-8799
www.summitappliance.com

SUMMIT

For parts and accessory ordering,
troubleshooting and helpful hints, visit:
www.summitappliance.com/support

Printed in the U.S.A.