

ID-30R



FEATURES

Accepts custom panels for an integrated look within cabinetry or stainless-steel accessory panels and handles to match other Sub-Zero, Wolf, and Cove products

Controls temperature within one degree of setpoint

Assure maximum freshness with low-temp, high-humidity crisper and deli drawers

Locks in cold air to ensure freshness with magnetic door seals

Control brightness with soft-on LED lighting

Open and close doors silently with soft-close technology

ACCESSORIES

Crisper Cover

Dual Installation Kit

Egg Container

Reduced Toekick Divider

Stainless Steel Pro Handles

Stainless Steel Tubular Handles

Stainless Steel Drawer Panels With Pro Handles - 4" Toe Kick

Stainless Steel Drawer Panels With Pro Handles - 6" Toe Kick

Stainless Steel Drawer Panels With Tubular Handles - 4" Toe Kick

Stainless Steel Drawer Panels With Tubular Handles - 6" Toe Kick

Stainless Steel Dual Installation Kickplates

Accessories are available through an authorized dealer.
For local dealer information, visit subzero-wolf.com/locator.



HANDLE ACCESSORIES

PRO



TUBULAR



PRODUCT DETAILS

REFRIGERATOR

- Adjustable drawer dividers
- LED lighting

PRODUCT SPECIFICATIONS

Model	ID-30R
Dimensions	30"W x 34 1/2"H x 24"D
Drawer Clearance	18 3/8"
Weight	210 lbs
Refrigerator Capacity	5.2 cu. ft.
Electrical Supply	115 VAC, 60 Hz
Electrical Service	15 amp dedicated circuit

ELECTRICAL

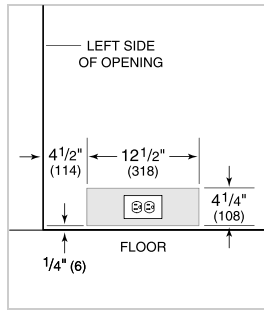

PANEL SPECIFICATIONS For complete panels specifications including width/height, weight requirements and thickness requirements visit subzero-wolf.com/reveal.

NOTE: Dimensions in parenthesis are in millimeters unless otherwise specified

INTERIOR VIEW

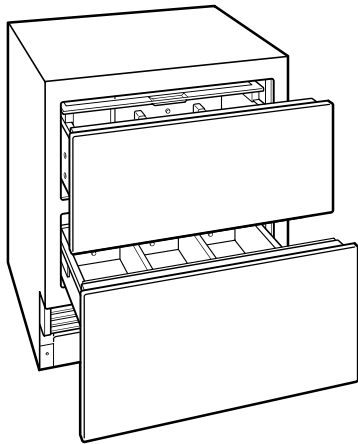

This illustration is intended for interior reference only and may not represent the exterior of the model being specified.

DIMENSIONS

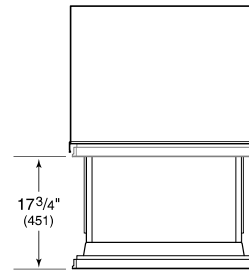
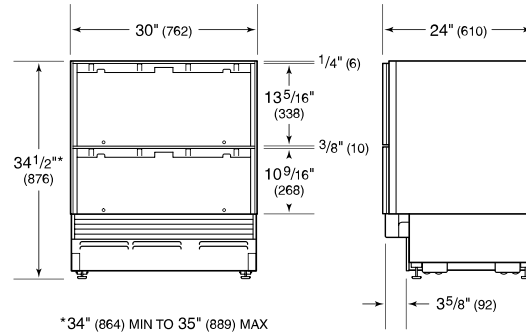

STANDARD INSTALLATION

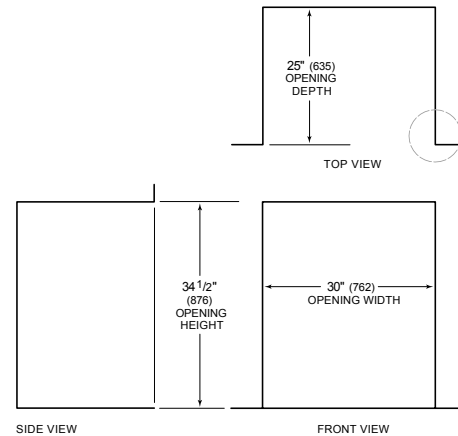

NOTE: 3 1/2" (89) finished returns will be visible and should be finished to match cabinetry

