



CAUTION! Remove Doors

Always remove the doors from your medicine cabinet during installation (see page 3) and store them away from the work area. This will make your cabinet lighter, easier to move and position, and safer to handle. Doors open unexpectedly and unbalance the cabinet while you are moving it, causing personal injury or damage to your cabinet. Plus, door faces will be protected from damage during installation. If stored away from your project.

Damage caused during installation is not covered by warranty.

Installing Simplicity Medicine Cabinets

Our medicine cabinet mounting system is easy to use and very secure.

1. Remove the doors for ease of handling and safety.
2. Determine the desired location of the Medicine Cabinet (before crown molding is installed) and mark the wall at top center of the Cabinet box. See Figure 1.

Figure 1.

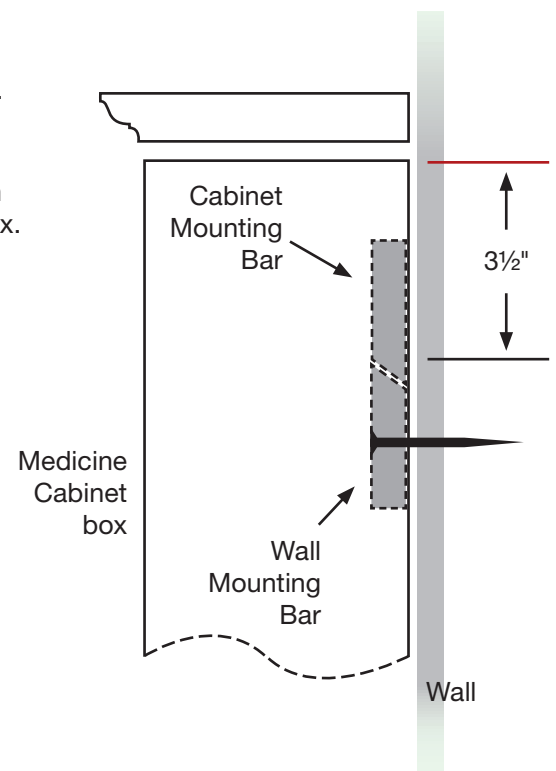
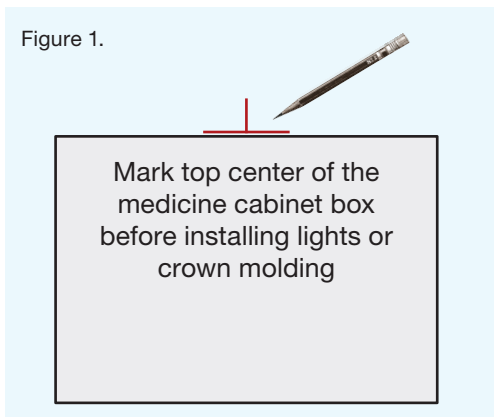

3. Measure down 3½" and make a level horizontal line. The top edge of the Wall Mounting Bar will be at this line. See Figure 2.

Figure 2.

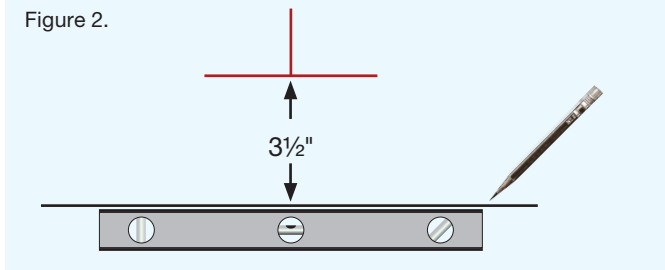

4. Locate wall studs. Use two to four large (min. 3") screws to secure Wall Mounting Bar to the wall. Pre-drill screw holes in the bar slightly larger than the screws being used. Run screws through bar, sheetrock and well into studs. If you are not familiar with types of screws, load, or how to do this for your specific application; ask at a home center. Do not bend the Wall Mounting Bar even if wall is curved. Use shim(s) where necessary.
5. Place Medicine Cabinet against the wall and slide down until the Medicine Cabinet Mounting Bar mates with the Wall Mounting Bar.

Changing Medicine Cabinet Door Swing

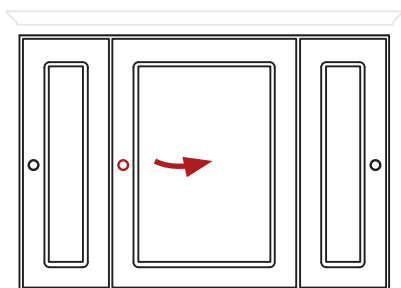

To change the door swing from *left-opening* to *right-opening* or vice versa, simply rotate the cabinet body 180 degrees and hang on your wall.

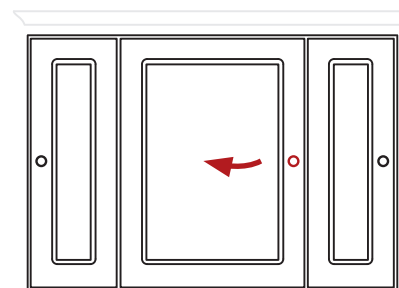

Removing and Re-installing Doors with 6-way Adjustable Hinges

To remove doors, loosen screw indicated on both hinges of a door at least 2 full turns. Slide door outward as shown and disengage.

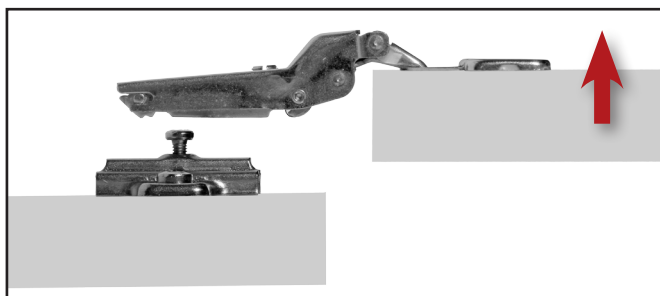
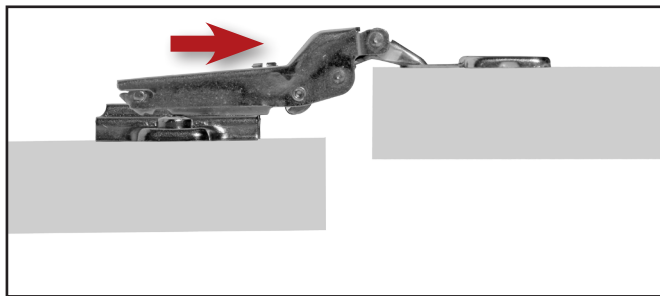
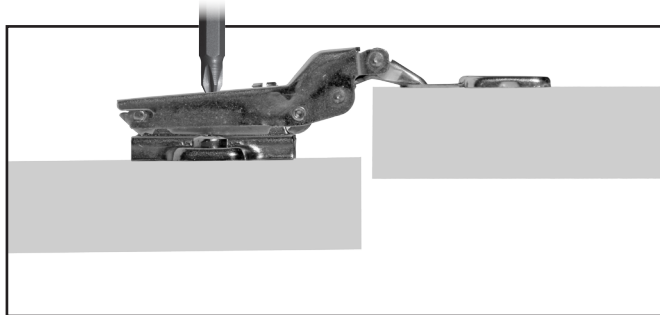

To re-install doors, simply reverse the removal process. Tighten screws part way, adjust door position, and tighten the screws securely.

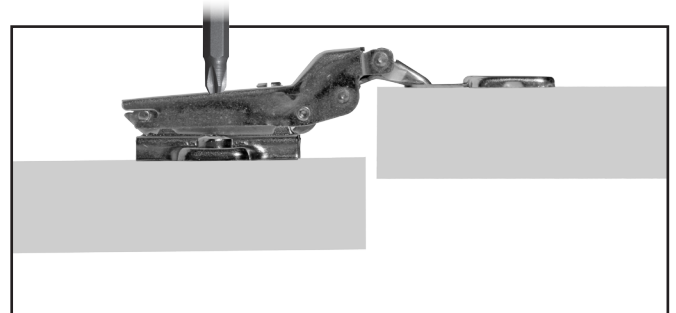
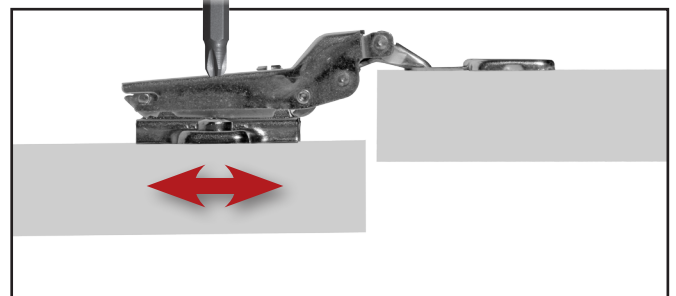
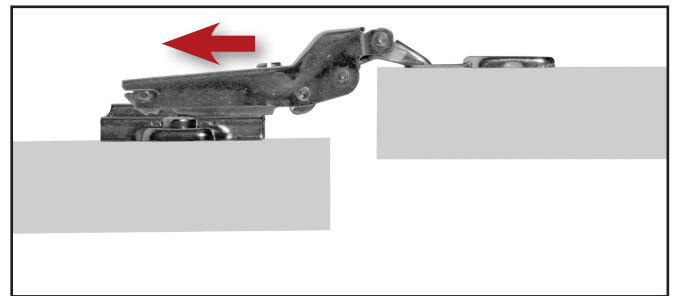
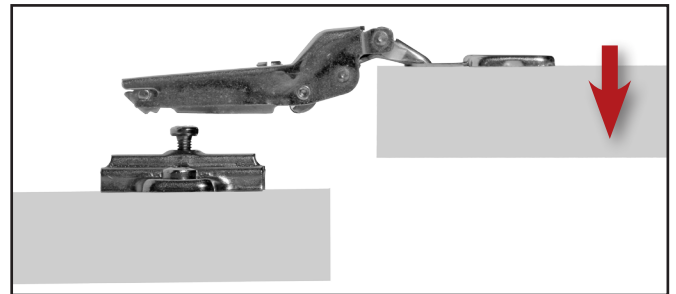

Adjusting Door Face Alignment

Adjusting door up & down

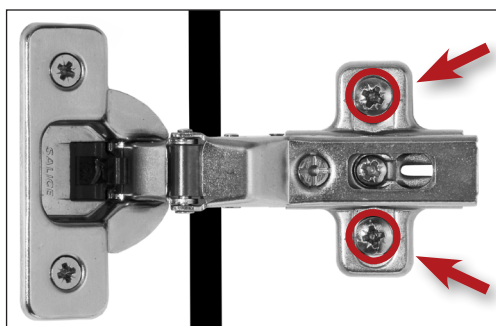
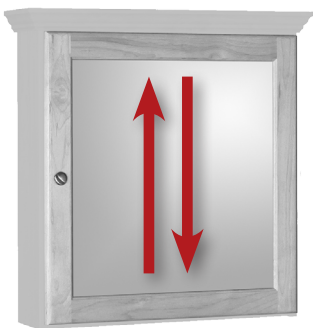

Loosen indicated screws on **both** hinges to adjust door up/down. **Never** adjust one hinge without also adjusting the other hinge.

Note: you may need to tap hinge hardware up or down as it may be stuck to cabinet finish initially.

Adjusting door in & out

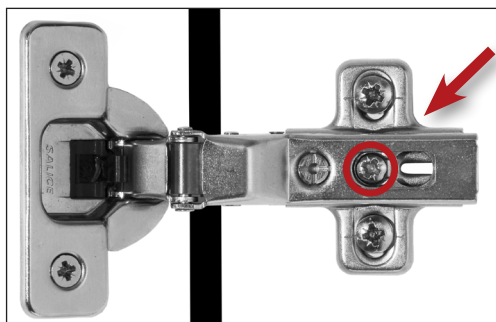

Loosen indicated screw $\frac{1}{2}$ turn and adjust door in/out. Then tighten.

Note: as the door corner at the hinge moves in one direction, the diagonally opposite corner moves in the other direction.

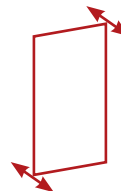

Adjusting door left & right

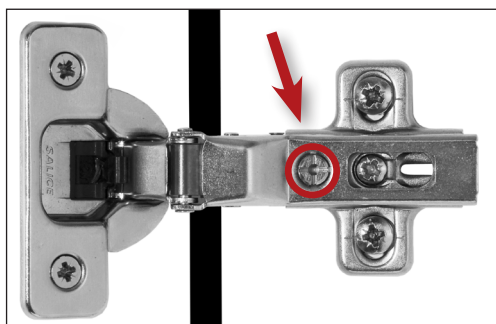
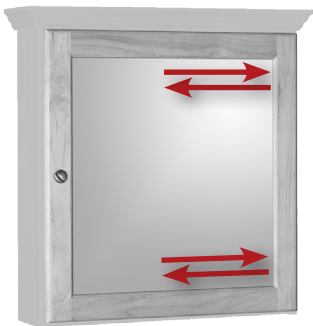

Simply turn indicated screw to adjust door left/right.

Cleaning

- **Always** use only a damp soft cloth to clean your medicine cabinets.
- **Never** use abrasive cleansers on any part of your cabinet.
- **Never** use a scouring sponge.
- **Never** use bleach, solvents (like nail polish remover), or harsh cleaners on your cabinets.
- **Clean mirrors** with a glass cleaner that does **not** contain ammonia or vinegar and use only on glass surfaces.
Never use a glass cleaner on the finished frames of mirrors or any other non-glass surfaces of your Simplicity cabinets! Doing so will, over time, damage the finish.

If you have questions, don't hesitate to call our Customer Service
Toll Free 1-800-445-0494, 7AM-4PM Pacific Coast Time.

Thank you for purchasing Strasser Woodenworks Products for your bath.

Crafted in USA. to Last a Lifetime

