



STEAM BATH GENERATOR USER GUIDE

BLACK SERIES

MODELS

4.5KW

6KW

7.5KW

9KW

10.5KW

12KW

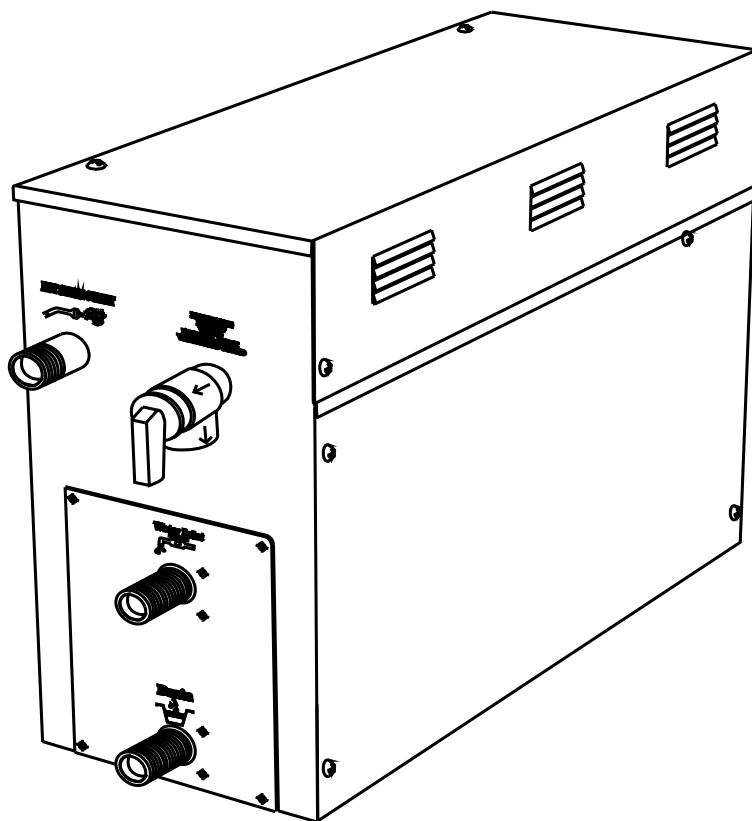

DON'T WAIT! REGISTER NOW!

Register your product within 90 days to ensure your steam bath generator is recognized as an official purchase and is eligible for warranty coverage.

Mail in the completed registry card (Pg. 2) or register online at www.SteamSpa.com/register.



PRODUCT REGISTRATION*

IMPORTANT: Your warranty will not be recognized unless this card is fully completed and returned or online registration is completed.

To ensure that your warranty is registered and confirmed please do one of the following:

1. Register online at www.SteamSpa.com/register. You will be asked to fill out the same information you would in the registration card. Registering online is fast, secure and ensures we receive your information.

2. Complete, cut-out and mail the registration card below. By returning this registration card we confirm the date of purchase for your new product. This confirmation will allow us to process any warranty claims.

Mail the card to: 5701 NW 35 Avenue, Miami, FL 33142



Product Registration Card

Name Address

City State Zip

Phone Email.....

Date of Purchase..... **Order or Purchase #**..... **SKU or Model #**.....

Installer's Name Phone

I have read the Owner's Guide carefully and understand and agree that any installation, operation or maintenance of the steam generator and generator accessories must be done strictly in accordance with instructions and guidelines contained in the owner's manual and installation guide.

Signature..... **Date**.....

IMPORTANT WARRANTY INFORMATION!



The installation of a quick connect and release system is essential to the care and maintenance of your steam bath generator unit. Additionally, the use of an inline water filter with fresh cartridges prevents mineral deposit and built up from damaging the generator's internal plumbing and components.

Please be advised failure to comply with any of the following will VOID the warranty.

1. The User must register product within 90 days of delivery. See www.SteamSpa.com/register.
2. Installation must be performed by a licensed professional.
3. A quick connect & release system must be used for reliable periodic maintenance.
4. An inline water filter must be installed to prevent mineral deposit and build up.
5. Filter cartridge must be replaced no later than every 6 months.

Malfunctions, damages, parts replacement and labor resulting from improper installation, negligence, or lack of care and maintenance will NOT be covered under the SteamSpa Warranty.

For more information visit www.SteamSpa.com/warranty or call 1-800-856-0172.

STEAM QUICK CONNECT & RELEASE KIT w/ WATER FILTER PLUS EXTRA CARTRIDGES STMKIT-02



READ ME FIRST!

IMPORTANT NOTE: As you follow these instructions, you will notice warning and caution symbols. This blocked information is important for the safe and efficient installation, operation and maintenance of this generator. These are types of potential hazards that may occur during this installation and operation:

 **WARNING** states a hazard may cause serious injury or death if precautions are not followed.

 **CAUTION** signals a situation where minor injury or product damage may occur if you do not follow instructions.

IMPORTANT NOTE: This highlights information that is especially relevant to a problem-free installation.

IMPORTANT SAFETY INSTRUCTIONS

When installing and using this electrical equipment, basic safety precautions should always be followed, including the following:

1. READ AND FOLLOW ALL INSTRUCTIONS

2.  **WARNING** To reduce the risk of injury, children under the age of 16 should not use the steam bath.

3.  **WARNING** To reduce the risk of injury:

- A. The wet surfaces of steam enclosures may be slippery. Use care when entering or leaving.
- B. The steam head is hot. Do not touch the steam head and avoid the steam near the steam head.
- C. Prolonged use of the steam system can raise excessively the internal human body temperature and impair the body's ability to regulate its internal temperature (hyperthermia). Limit your use of steam to 10-15 minutes until you are certain of your body's reaction.

D. Excessive temperatures have a high potential for causing fetal damage during the early months of pregnancy. Pregnancy or possibly pregnant women should consult a physician regarding correct exposure.

E. Obese persons and persons with a history of heart disease, low or high blood pressure, circulatory system problems, or diabetes should consult a physician before using a steam bath.

F. Persons using medication should consult a physician before using a steam bath since some medication may induce drowsiness while other medications may affect heart rate, blood pressure and circulation.

4. SAVE THESE INSTRUCTIONS

HYPERTHERMIA

The causes, symptoms, and effects of hyperthermia may be described as follows: Hyperthermia occurs when the internal temperature of the body reaches a level several degrees above the normal body temperature of 98.6° F. The symptoms of hyperthermia include an increase in the internal temperature of the body, dizziness, lethargy, drowsiness, and fainting.

The effects of hyperthermia include:

- a) Failure to perceive heat
- b) Failure to recognize the need to exit the steam bath
- c) Unawareness of impending risk
- d) Fetal damage in pregnant women
- e) Physical inability to exit the steam bath
- f) Unconsciousness.

 **WARNING** The use of alcohol, drugs, or medication can greatly increase the risk of hyperthermia.

 This peel-n-stick warning label must be applied to the wall of the shower or steam enclosure, at a point visible to all users. Failure to install sticker may result in serious injury or death. For replacement label contact SteamSpa at 1-800-856-0172 or info@steamspa.com.

WARNING

REDUCE THE RISK OF OVERHEATING AND SCALDING

1. EXIT IMMEDIATELY IF UNCOMFORTABLE, DIZZY OR SLEEPY. STAYING TOO LONG IN A HEATED AREA IS CAPABLE OF CAUSING OVERHEATING.
2. CHILDREN UNDER THE AGE OF 16 SHOULD NOT USE THE STEAM BATH.
3. CHECK WITH A DOCTOR BEFORE USE IF PREGNANT, DIABETIC, IN POOR HEALTH OR UNDER MEDICAL CARE.
4. BREATHING HEATED AIR IN CONJUNCTION WITH CONSUMPTION OF ALCOHOL, DRUGS, OR MEDICATION IS CAPABLE OF CAUSING UNCONSCIOUSNESS.
5. DO NOT CONTACT STEAM HEAD OR STEAM AT THE STEAM HEAD.

REDUCE THE RISK OF SLIPPING AND FALL INJURY

1. USE CARE WHEN ENTERING OR EXITING THE STEAM ROOM. FLOOR MAY BE SLIPPERY.

NOTE: FOR ADDITIONAL SAFETY CONSIDERATIONS SEE OWNER'S MANUAL

TABLE OF CONTENTS

PROLOGUE.....	6
USER INSTRUCTIONS	6
CHOOSING THE RIGHT LOCATION	6
INSTALLATION DRAWING OF STEAM GENERATOR	7
PLUMBING INSTALLATION	10
STEAM GENERATOR SPECIFICATIONS	12
ELECTRICAL REQUIREMENTS	13
ASSEMBLY GRAPH FOR POWER WIRE	14
WIRING DIAGRAM.....	15
STEAM GENERATOR DISSECTION DIAGRAM.....	17
CARE & USE FOR THE CONTROL PANEL	18
CONTROLLER BOX CONTENT	18
CONTROL PANEL INSTALLATION INSTRUCTIONS	20
INSTALLING LIGHT	25
INSTALLING SPEAKERS	25
TESTING MACHINE	26
STEAM GENERATOR MAINTENANCE	29
TROUBLE SHOOTING	28
TECHNICAL PARAMETERS.....	31
STEAM SPA TROUBLE SHOOTING	32

IMPORTANT!

PRIOR TO INSTALLATION, LET WATER RUN THROUGH THE WATER PIPE TO CLEAN ANY POSSIBLE DEBRIS BEFORE CONNECTING THE GENERATOR.

PROLOGUE

Thank You for choosing SteamSpa for health, beauty and relaxation. Now you can enjoy your own private sanctuary in the comfort of your own home. Let your stress melt away as you relax in your state of the art Steam Room.

WARRANTY

SteamSpa warrants that this steam bath generator unit will be free from manufacturer defects and malfunctions. For terms and condition please refer to latest SteamSpa Warranty at www.SteamSpa.com/warranty.

Please be advised failure to comply with any of the following will VOID the warranty.

1. Generator and Use are registered within 90 days of delivery. See www.SteamSpa.com/register.
2. Installation must be performed by a licensed professional.
3. A quick connect & release system must be used for reliable periotic maintenance.
4. An inline water filter must be installed to prevent mineral deposit and build up.
5. Filter cartridge must be replaced no later than every 6 months.

USER INSTRUCTIONS

1. Check for visible damages upon delivery of Generator. Any damages to packaging should be reported immediately to shipping company delivery representative and SteamSpa's Customer Service Dept.
2. Check model and accessories are correct, including voltage input. Any discrepancies are to be reported to SteamSpa's Customer Service Dept. within 48 hours of delivery.
3. Read installation instructions in detail for a secure and effective installation of SteamSpa generators.
4. SteamSpa recommends the use of a licensed plumber and electrician for proper installation of SteamSpa generators.
5. SteamSpa shall not be responsible for product damage or malfunction caused by self-installation or installation procedures which do not comply with user manual.
6. SteamSpa generators are for indoor use only.

CHOOSING THE RIGHT LOCATION

1. The generator should be less than 25ft from the steam room for best performance.
2. The steam generator should not be installed in the steam room
3. Do not install outdoor or in any places that will influence the performance of the machine by the environment.
4. Do not install in a frigid location or any places where the water will freeze.
5. Do not install near flammable chemicals.
6. Install in a dry place where the ventilation is good.
7. Install an exhaust fan outside of the steam room for the excess steam to be expelled from the shower room.
8. The steam generator has a hanging groove for wall installations..
9. Both sides and the top of the steam generator need to reserve at least 12 inches space.
10. The area where the machine is installed must be easily cleaned up and convenient for the disassembly of the machine.
11. The installation area must be convenient for the steam generator draining system.
12. The steam tube, safety valve, drain valve, water tube and steam outlet remain very heated after the steam generator has stopped working for some time.
13. The controller panel should be installed away from the steam head to avoid false readings, please read the instructions for the controller's installation and operation.

INSTALLATION DRAWING OF STEAM GENERATOR

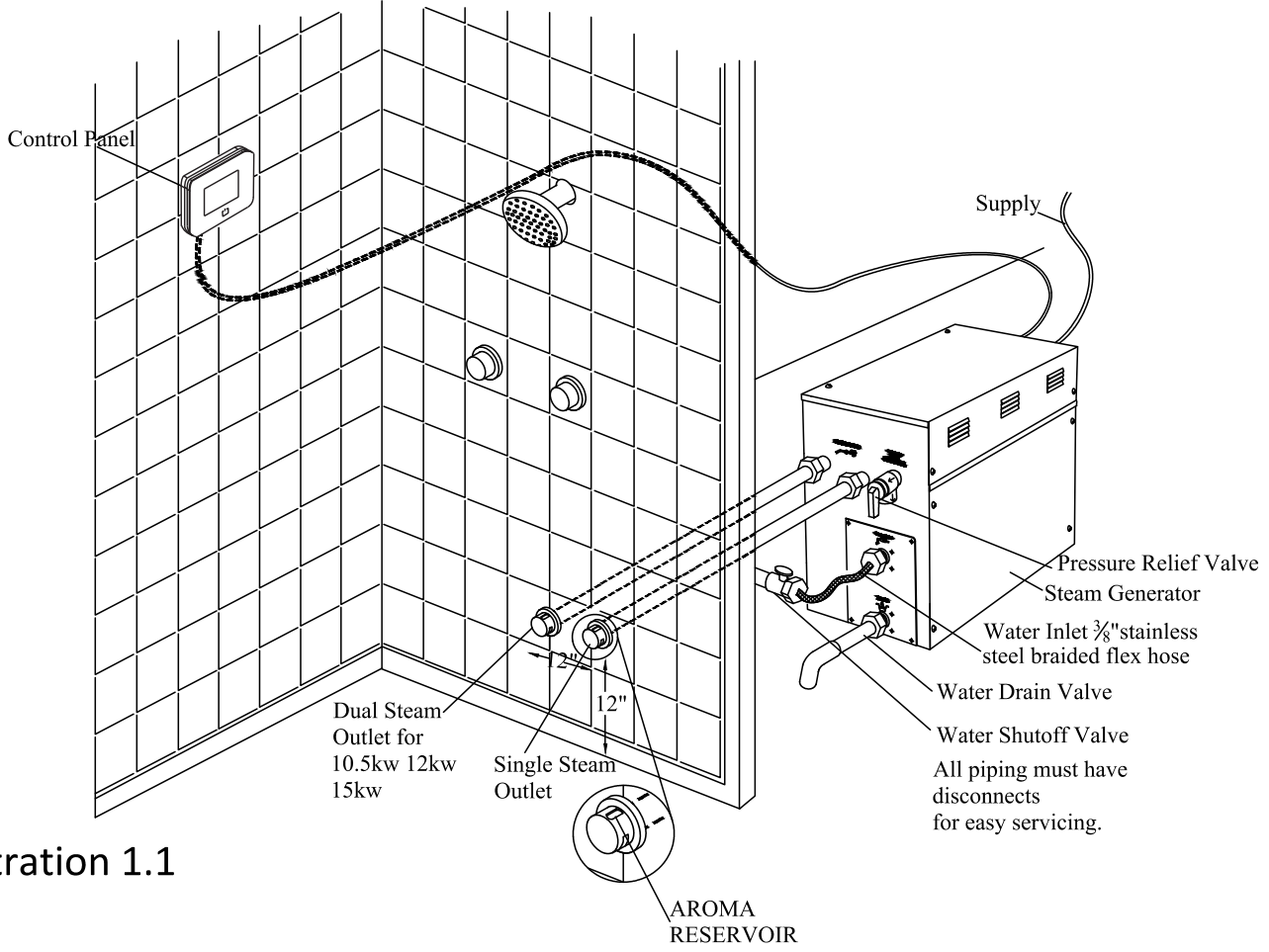

Illustration 1.1

ATTENTION! The drawing is only for explanation purposes. As for practical design of steam room, please consult with a qualified designer, architect or builder.

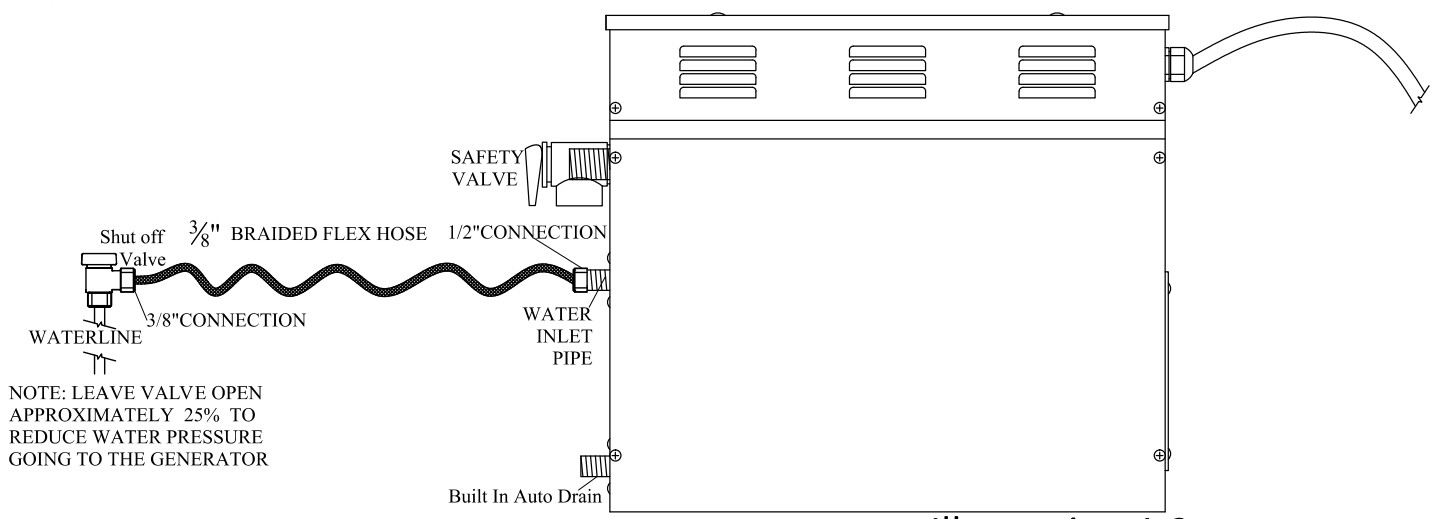

Illustration 1.2

INSTALLATION & USER GUIDE

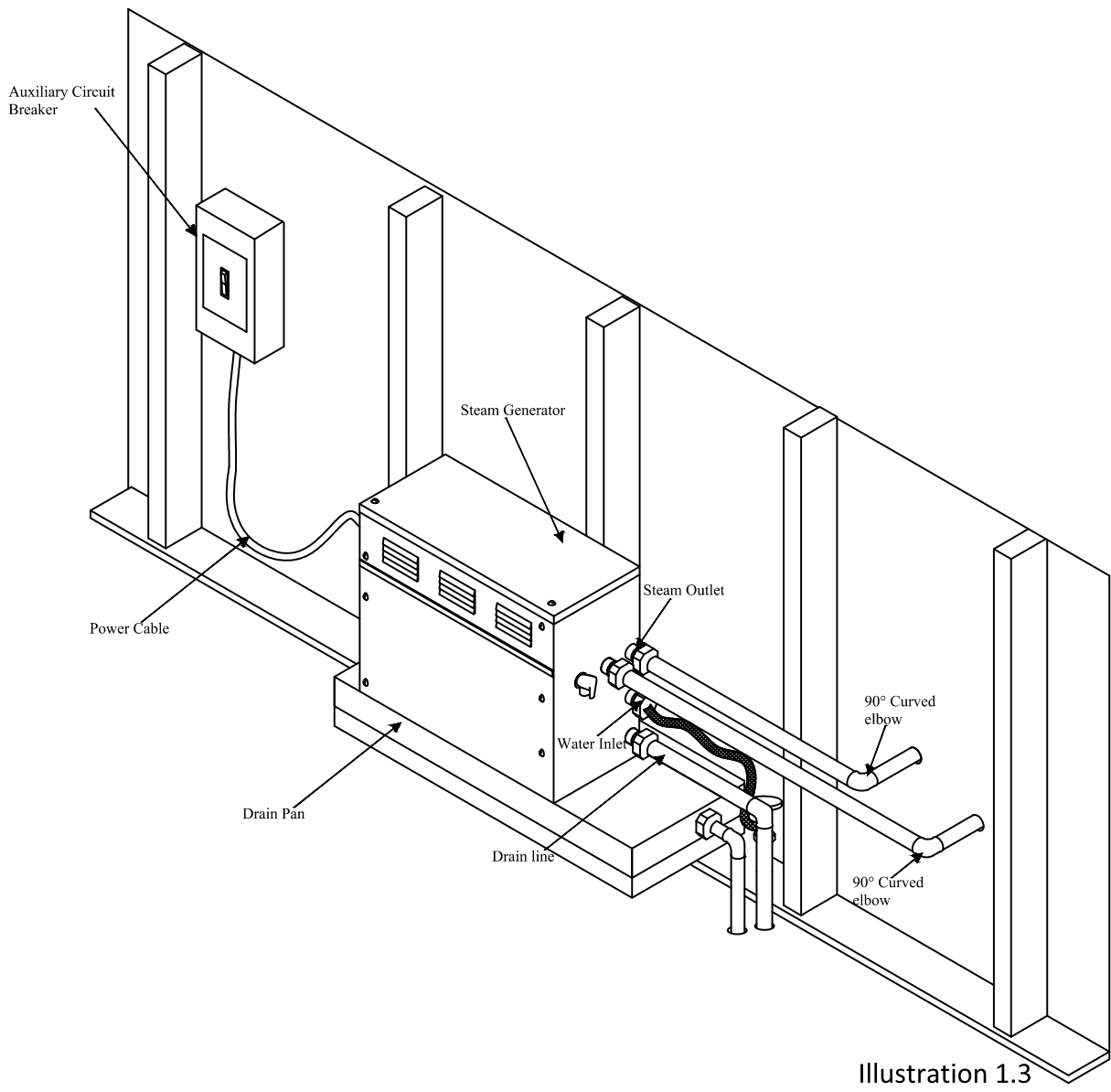
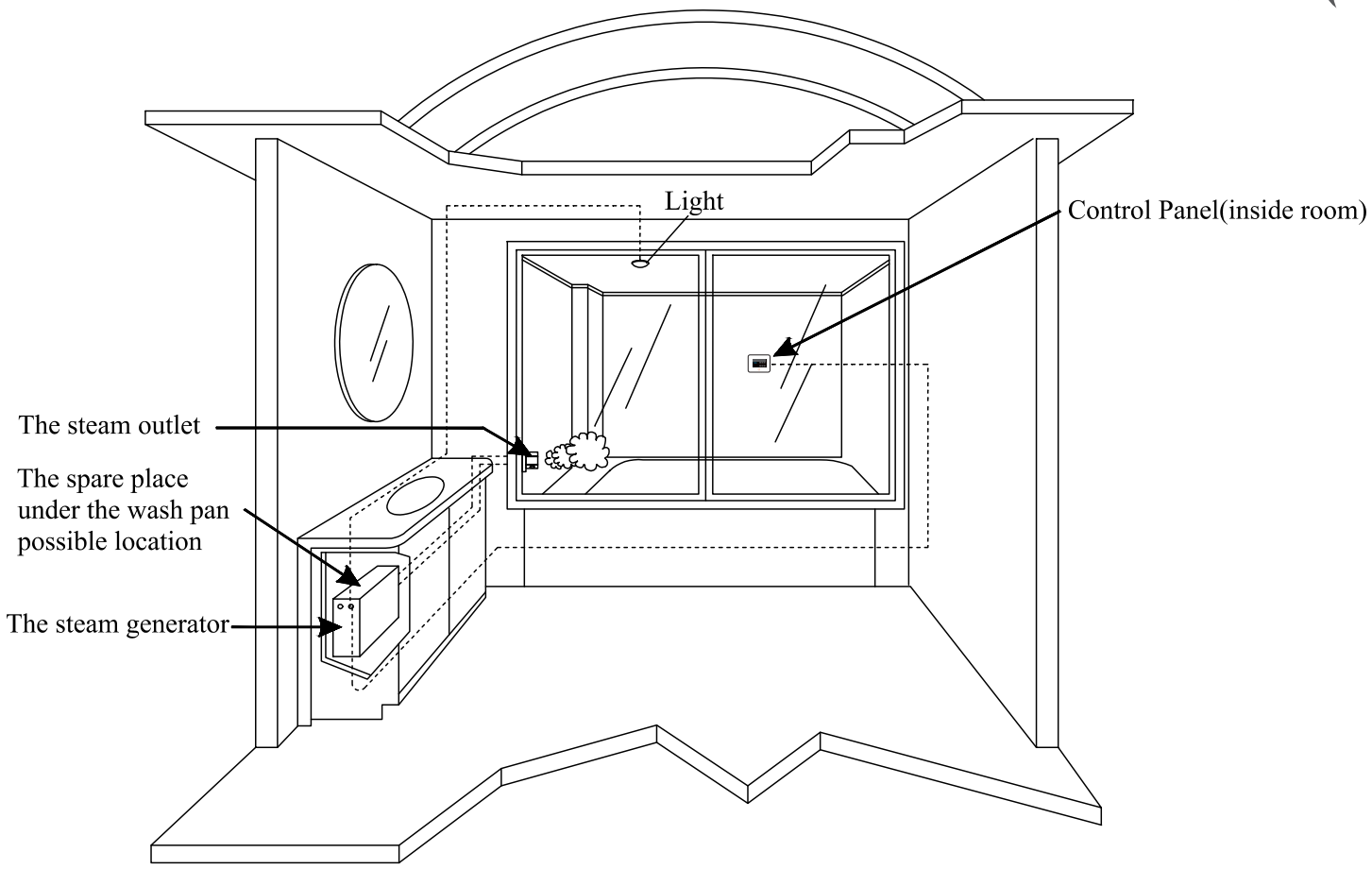

Illustration 1.3

ATTENTION! The drawing is only for explanation purposes, please consult with a qualified designer, architect or builder.

IMPORTANT! All pipe connections should have unions and adapters for easy disconnect.

ATTENTION! Proper installation is a critical requirement per the SteamSpa Warranty terms and conditions. A licensed professional must be used to ensure proper installation. A quick release system, inline water filter and regular maintenance are required.



ATTENTION! The illustration is just an example; the practical installation must comply with the nation's electrical criteria, and be done by a professional electrician.

The steam generator maybe installed in these location.

1. In closet located behind the shower.
2. In Attic
3. In basement etc.

ATTENTION! If the installation of the steam generator will be more then 10 to 15 feet away from the steam room. It is recommended to increase the size of the generator 1 or 2 kilowatts higher to increase the steam flow.

PLUMBING INSTALLATION

WARNING! The installation of all water supply lines should be in accordance to all national and local codes by a licensed plumber.

1. Use unions when connecting pipes.
2. Use brass pipes or copper pipe only.
3. Do not use black and galvanized or PVC pipes.

ATTENTION! Please ensure a quick connect and release system is employed when installing steam generator to plumbing. Doing so will ensure quick and easy access to the generator for regular care and maintenance and is a critical condition for an active SteamSpa Warranty protection.

WATER SUPPLY PIPE (1/2")

1. Connect hot water or cold water pipes. However it should not exceed 160F.
2. Install a shut off valve in the water supply line. The shut off valve should be installed in a place where it is easily accessible in case of an emergency.
3. Flush the water supply line completely before connecting the water pipe to the steam generator, to remove any sediments in the water.
4. Use a 3/8" steel braided flex hose with a shut off valve to connect the main waterline to the generator. See page 5 illustration 1.2.
5. The shut off valve should be open approximately 25% to reduce water pressure to the generator. The water pressure to the generator should be between 15 to 20 PSIG if necessary, decrease the pressure accordingly.
6. If necessary, install a Hydro pneumatic device which reduces pressure spikes.
7. Do not use PEX or PVC tubing.

STEAM PIPE (3/4")

1. Do not install any stop valves in the steam pipes. The steam can never be obstructed.
2. Install a 3/4" copper or brass pipe between the steam generator and the steam nozzle.
3. If needed, the heat insulation material used to insulate the steam pipe should be resistant to temperatures as high as 240F or higher.
4. The shorter the distance, the better. Use curved elbows when connecting pipes to allow the steam to flow smoothly through the steam pipe.

STEAM HEAD (3/4")

ATTENTION! Steam Head and the steam outlet gets very hot, try to avoid installing the steam head in a position which will easily come into contact with the person bathing.

1. Install the steam head approximately 12 inches above the ground floor. If the steam room material is acrylic or non-heat-resistant sheet, please consult with material manufacturer about steam room applications.
2. The steam head outlet should be installed face down. To prevent scalding bather with steam or water.

ATTENTION! Tighten steam head by hand. Do not use a spanner or other tools, use a little soap water and soft sponge to wipe, and do not use erosive chemical solutions or crude cleaning tools.

IMPORTANT!

1. Please consult manufacturer of materials like acrylic, fiber glass or other anti-heat sheet about the installation of the steam head.
2. In the entire steam room, it is required that steam does not leak out. The pipes, its accessories and the holes should be air proof by applying sealant so that no steam will enter the holes in the wall.

DRAINPIPE (1/2")

ACCORDING TO THE NATIONAL AND LOCAL PLUMBING CODES: The steam generator drain valve should be equipped with a drainpipe. The steam generator drains the water by gravity. Check local code requirements for drain valves. Do not connect the safety valve or steam line to drain line.

SAFETY VALVE (3/4")

1. Safety valve is an automatic system that is actuated by pressure in order to prevent steam pressure increasing in the interior of the generator .
2. The pressure limit range of the safety valve is 15 PSIG and the pressure will begin to decrease if pressure should come over this value.
3. If it is allowed by local codes, provide the safety valve with exterior drainpipe.
4. Do not dismantle the pressure relief valve while generator is in operation..
5. To maintain the proper automatic operation of the safety valve, make sure the safety valve connection pipe is smooth.

STEAM GENERATOR SPECIFICATIONS

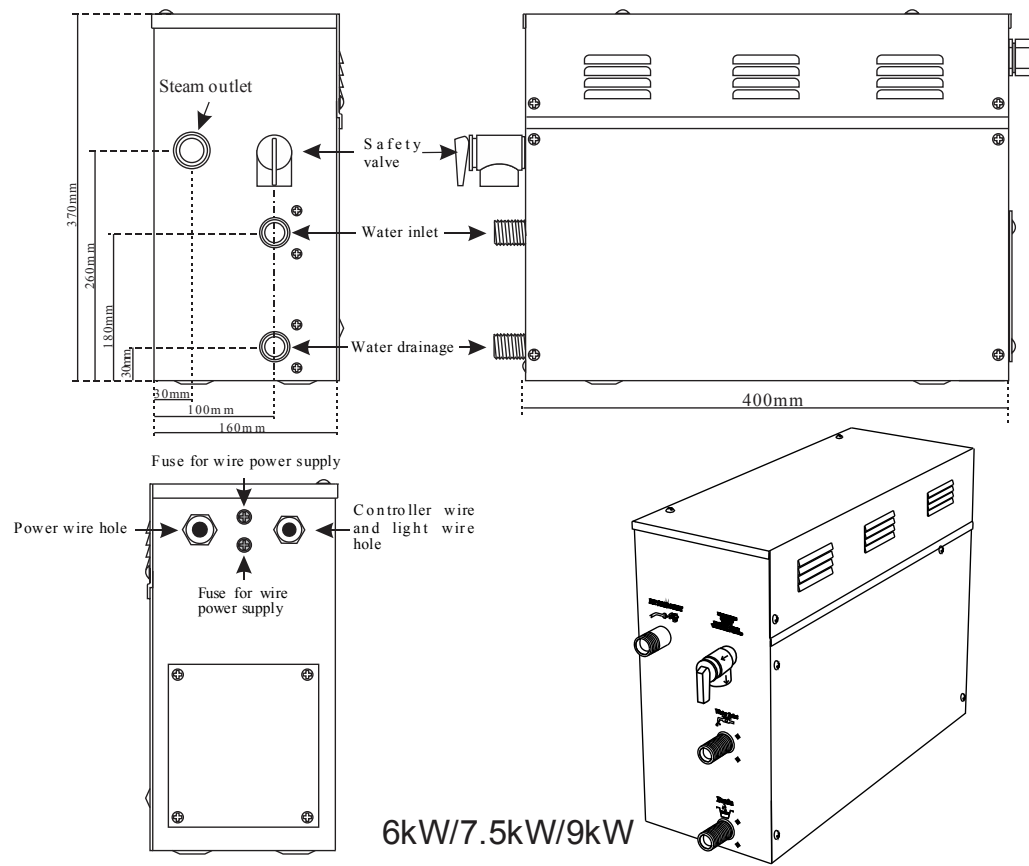
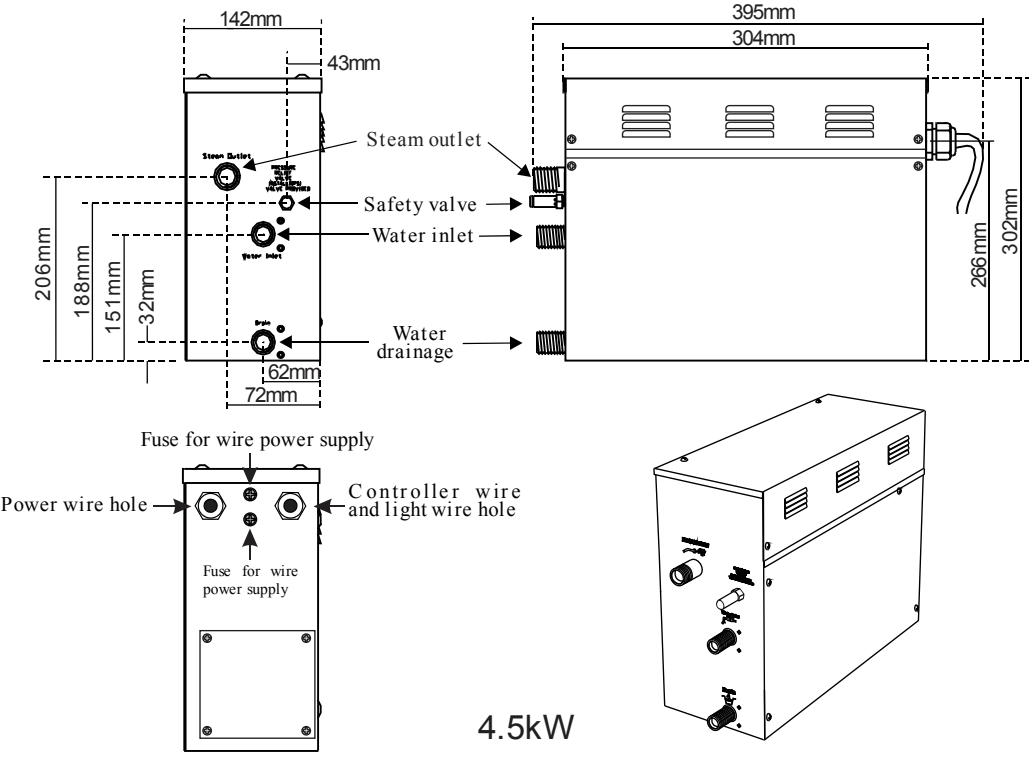

INSTALLATION & USER GUIDE

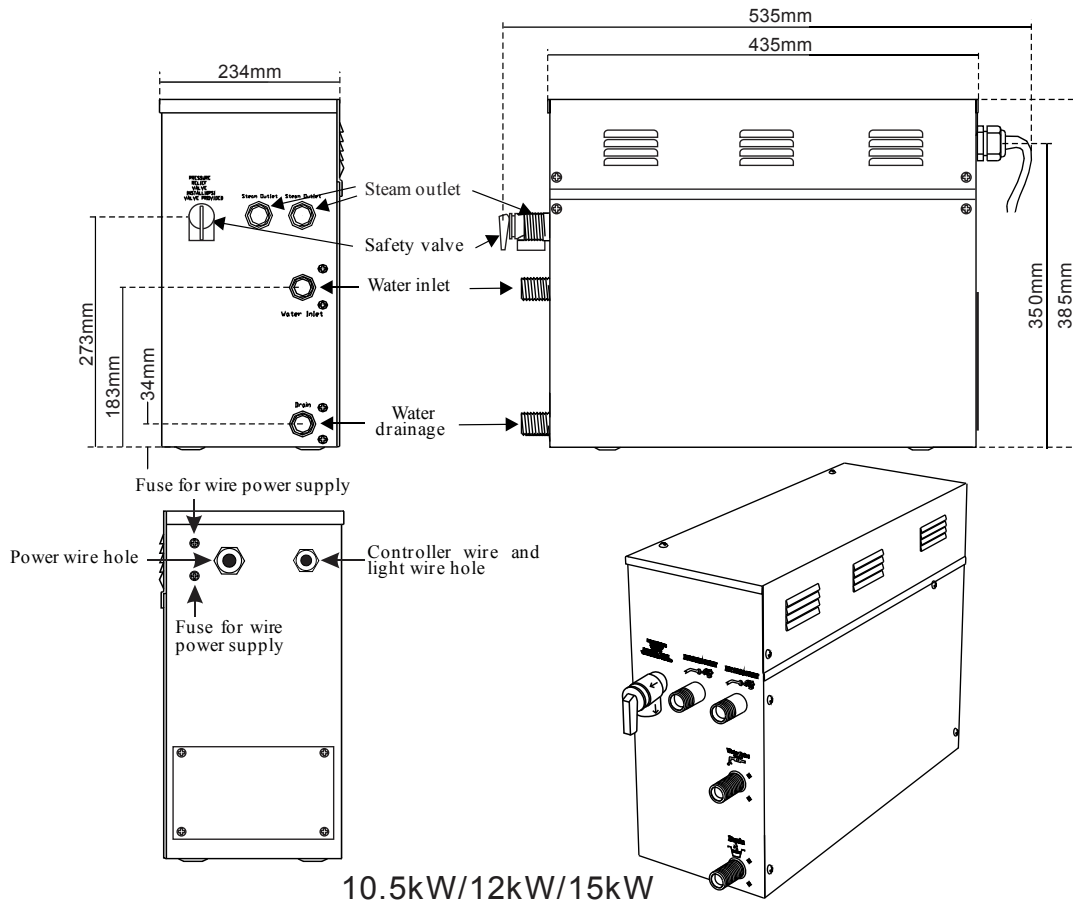

10.5kW/12kW/15kW

ATTENTION! To facilitate maintenance, keep the steam engine clean. If the information provided is limited, do not operate on the pipeline and electric equipment arbitrarily as shown in the figure for proportion.

ELECTRICAL REQUIREMENTS

ELECTRICAL SUPPLY CIRCUITRY

1. Test the voltage of the power supply and make sure suitable voltage is used for the steam generator.
2. Insulated copper wire should be used with an anti-heat temperature of 90 C and a specified voltage of 300V. Refer to national or local electricity consumption code for the specifications. Refer to the ammeter for the ampere.
3. Connect suitably sized equipment grounding wire into the ground terminal.
4. All the connections must be in accordance with national and local electricity consumption codes and be installed by professional electricians.

Ampere Meter

Type	Applicable space of the room (cu.Ft. *)	Power KW	Electricity supply (1PH)	Electric current (A)	Specifications for power wire (AWG)
B-450	90	4.5	240V	19	12
B-600	150	6	240V	25	10
B-750	225	7.5	240V	32	8
B-900	300	9	240V	38	8
B-1050	400	10.5	240V	44	6
B-1200	450	12	240V	50	6

The data provided above is for 240V single-phased motors. Install an independent circuit breaker between supply line and steam generator. Install a power disconnect within sight of steam generator to cut-off power when not in use.

ASSEMBLY GRAPH FOR POWER WIRE

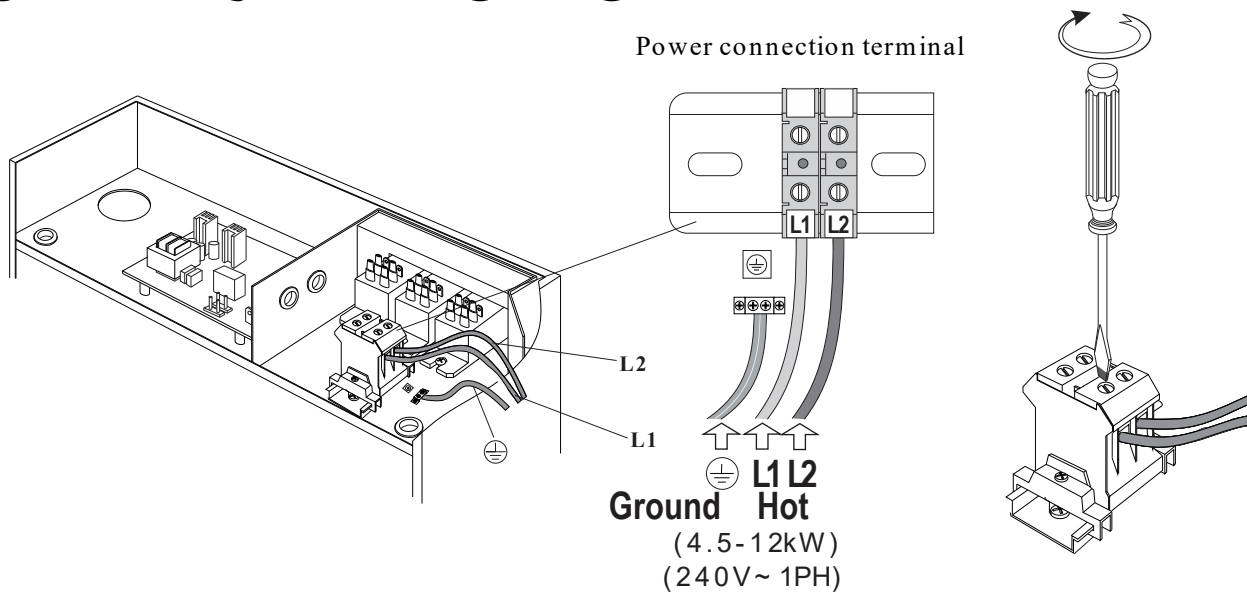

ATTENTION! To avoid damage to the equipment, do not connect electric current directly to heating elements.

WARNING! This graph is for explanation only. For actual installation, refer to national and local electricity consumption codes by professional electricians.

WIRING DIAGRAM

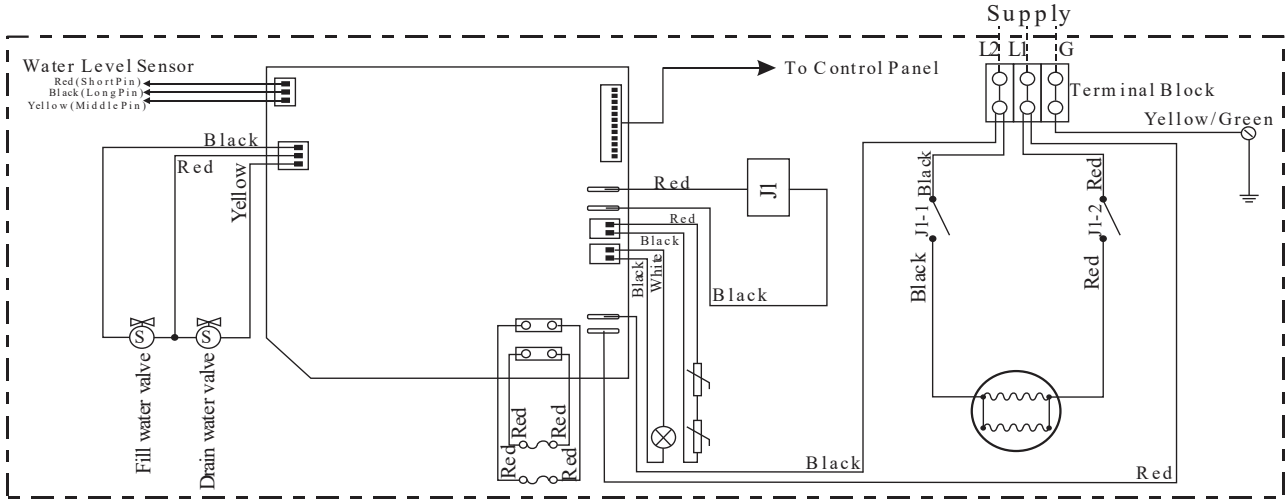

B-450

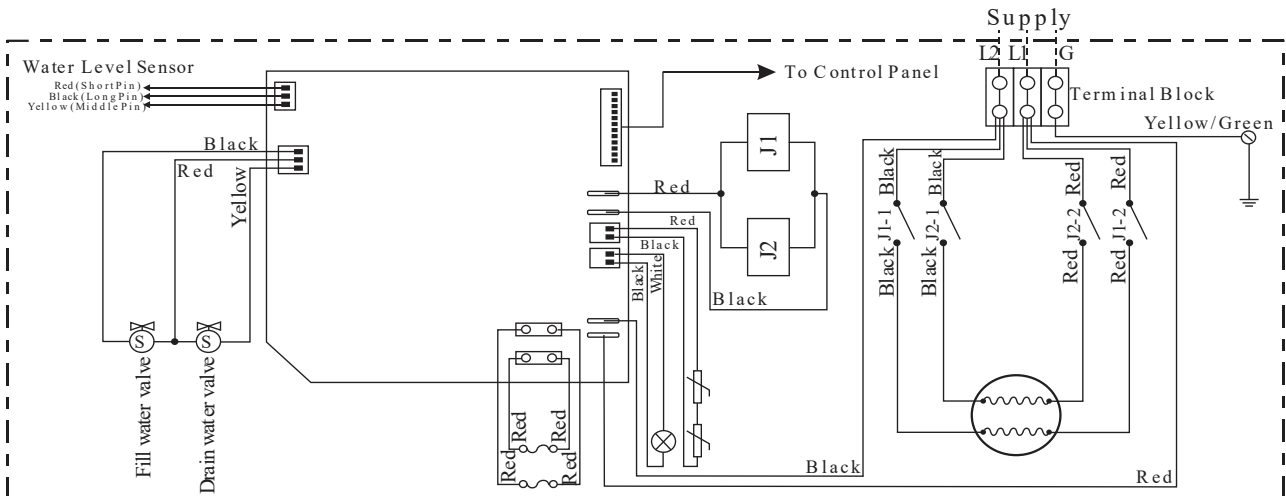

B-600

INSTALLATION & USER GUIDE

WIRING DIAGRAM

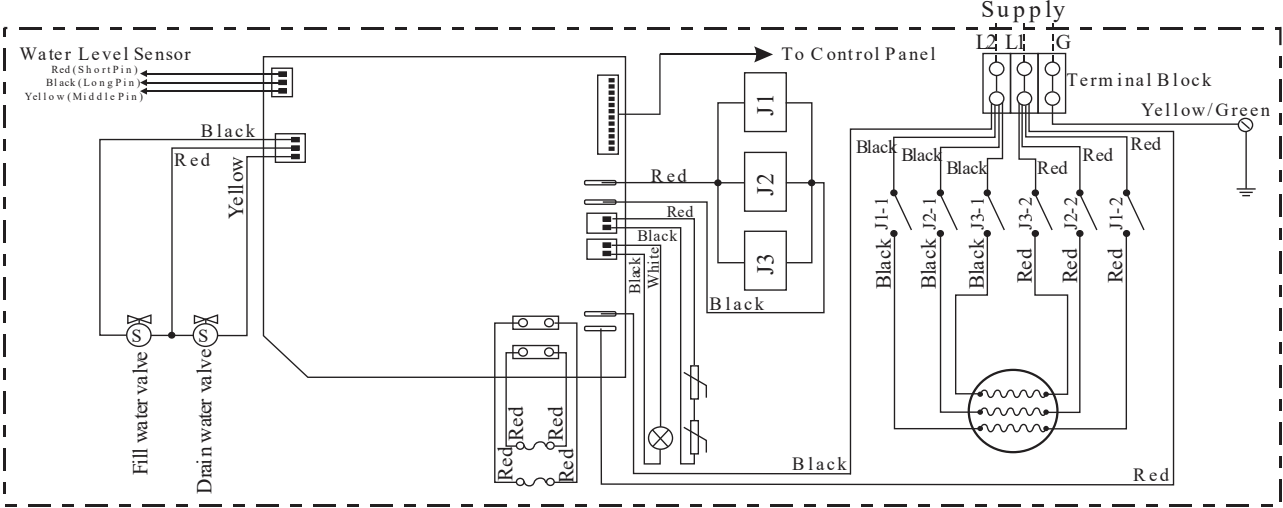

B-750 B-900

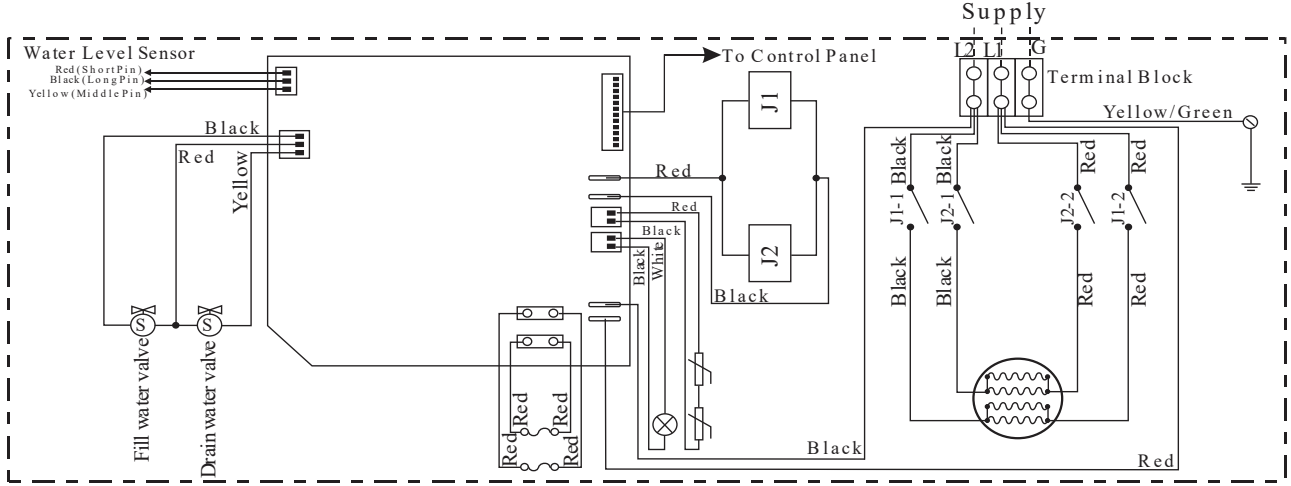

B-1050 B-1200

INSTALLATION & USER GUIDE

STEAM GENERATOR DISSECTION DIAGRAM

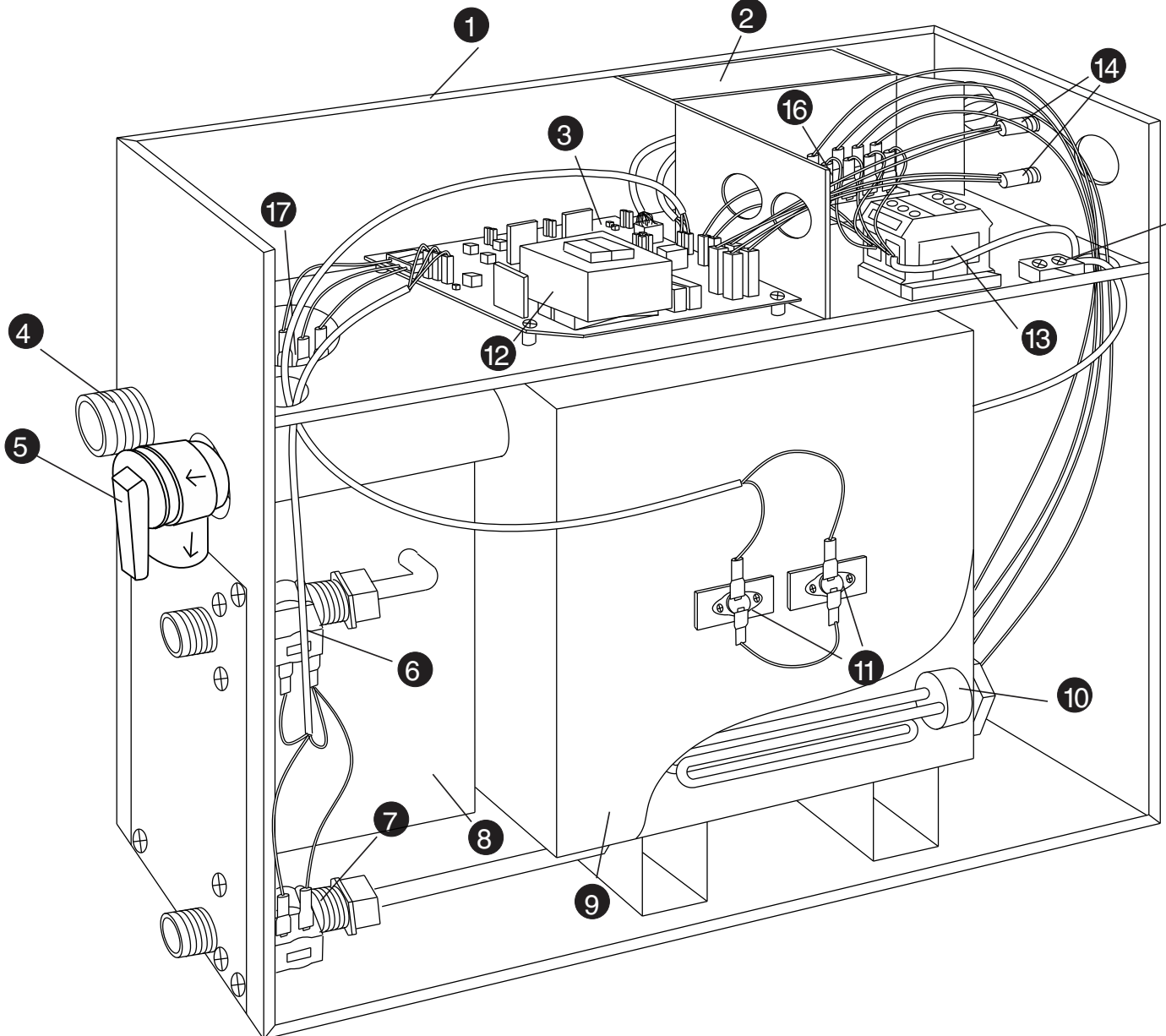

- | | | |
|--------------------------|--------------------------|---------------------------|
| 1. ENCLOSURE | 7. WATER DRAIN VALVE | 13. TERMINAL BLOCK |
| 2. INSULATION BRACKET | 8. SUBSIDIARY WATER TANK | 14. FUSE |
| 3. CIRCUIT BOARD | 9. MAIN WATER TANK | 15. GROUND WIRE CONNECTOR |
| 4. STEAM OUTLET | 10. HEATING ELEMENT | 16. RELAY |
| 5. PRESSURE RELIEF VALVE | 11. 221 F HI-LIMIT | 17. WATER LEVEL SENSOR |
| 6. WATER FILL VALVE | 12. TRANSFORMER | |

INSTALLATION & USER GUIDE

CARE & USE FOR THE CONTROL PANEL

1. Use soft cloth with a little soap water to clean the control panel.
2. Do not use crude cleaning tools.
3. If the decorating facade is damaged, contact service electrician to change it.

Do not install any SteamSpa controls without reading and understanding the SteamSpa generator Installation and Instruction manual. Failure to read and understand these instructions will result in inoperative control, generator, hazardous overheating, and/or inadequate heating of the steam room.

Do not route control wiring inside or close to power lines conduit, hot water or steam piping. Doing so may result in an inoperative control, generator, and/or hazardous installation.

Do not install SteamSpa controls with other than SteamSpa compatible steam generators. Doing so may result in possible generator damage or inoperative installation.

Single Control Panel with Temperature sensor must be installed inside bathing area 5 feet above floor. Do not install Control directly above Steam Head or below shower head but rather in the seating area on a vertical wall. Doing so may result in improper temperature reading and/or inoperable control.

Turn power to the steam generator off before connecting the control to the generator. Failure to turn the power off generator prior to connecting controls will result in an inoperable control.

Discontinue use of the steam generator or control if the steam generator is damaged. Continue to do so may result in an inoperative or hazardous installation.

CONTROLLER BOX CONTENT

- One (1) SteamSpa Black Control Console
- Two (2) Chroma Color Light
- One (1) LED White Light
- Two (2) Shower Speakers with Grills
- One (1) Rim Extension
- One (1) Control Box
- Four (4) Extension Cables
- User guide

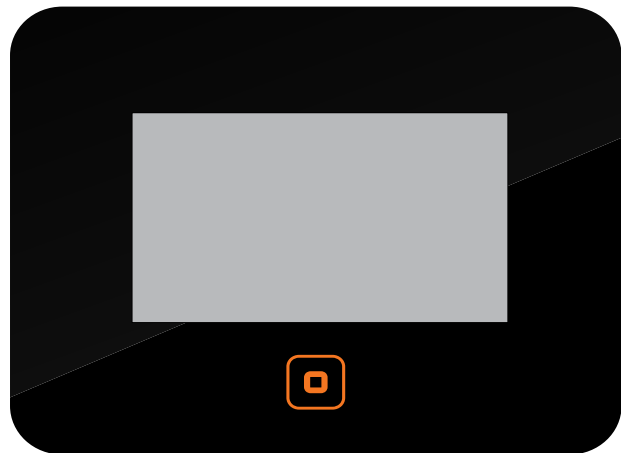

CONTROLLER SPECS

WITH EXTENSION RIM

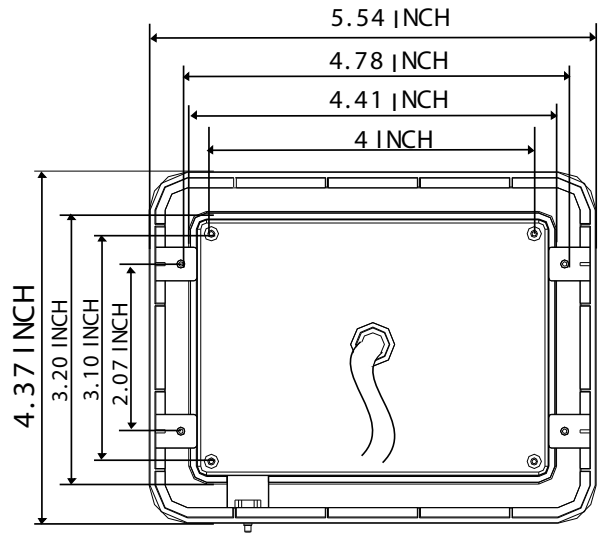
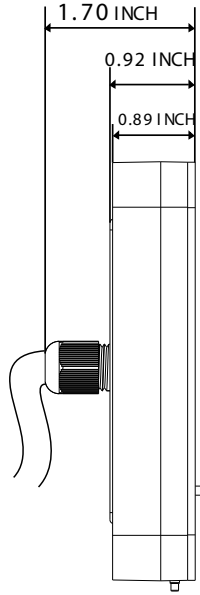
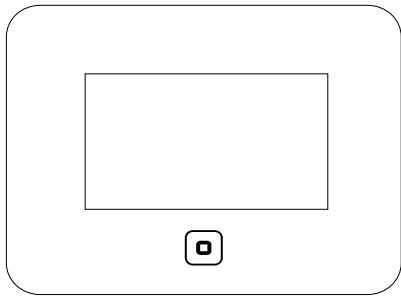

NO EXTENSION RIM

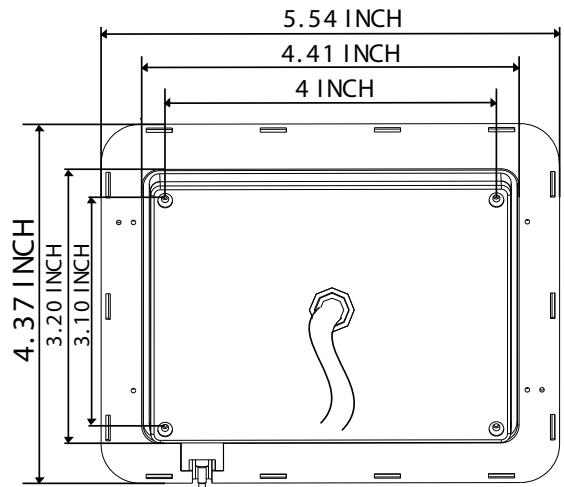
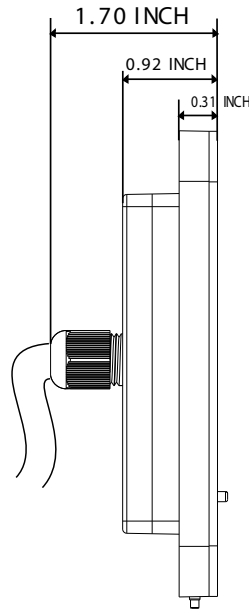
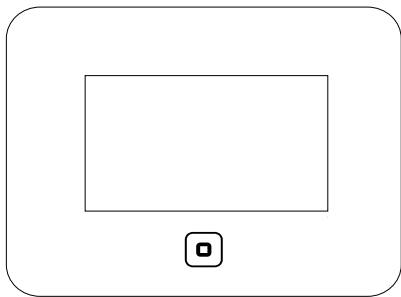

CONTROL PANEL INSTALLATION INSTRUCTIONS

STEP ONE

Determine the installation location of the control panel. The master control panel is designed to be installed in the steam room only, please install:

1. 4-5 feet from the ground.
2. Keep away from the steam head and do not expose under the direct spray of steam.
3. Install in the perpendicular wall.
4. The position of installation should facilitate easy operation and convenient wiring.

A. Recess mount onto the wall using the control box.

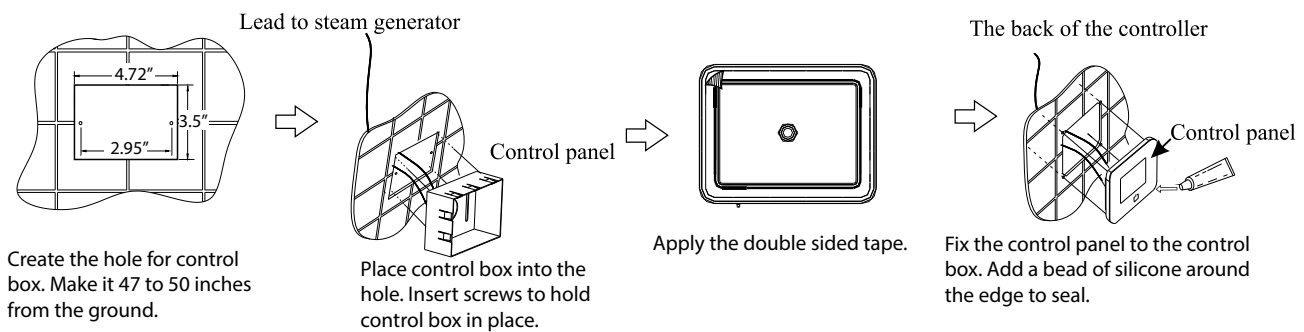

B. Recess mount with mounting plate.

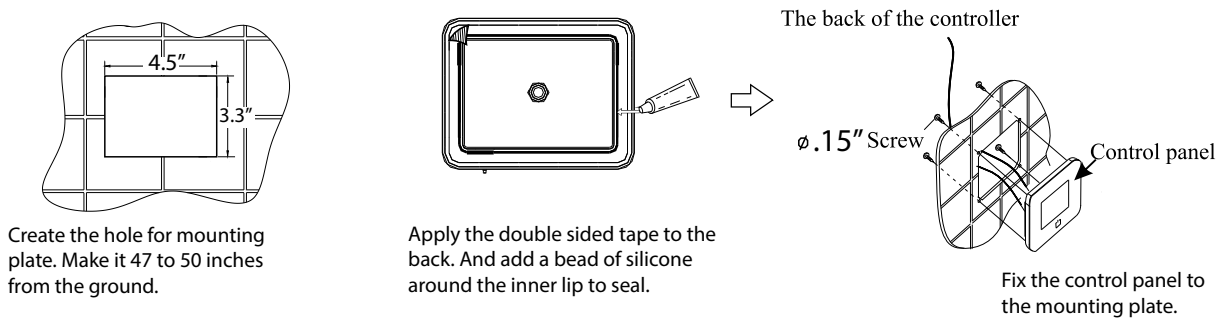

C. Using the double-sided adhesive.

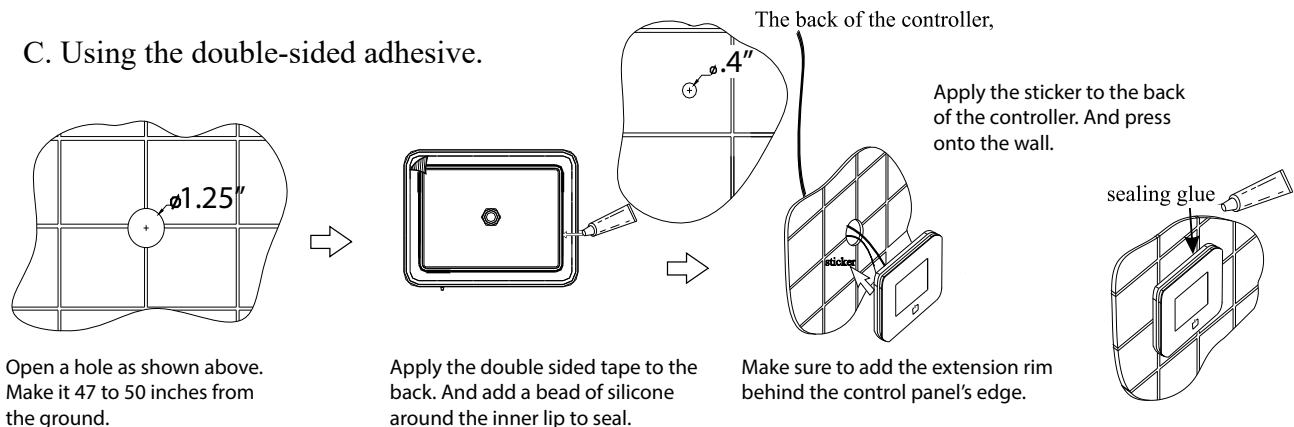

FUNCTIONS



LED LIGHT



STEAM



BLUETOOTH



CHROMA LIGHT

OPERATIONAL APPROACH

1. START-UP/SWITCH OFF

(1) POWER ON

The control panel will BEEP when it's connected to a power source.

(2) START-UP

When the system is under stand-by mode, press the  key to start-up. The current ambient temperature in the room and bluetooth music icon will be displayed on the screen as shown in Figure 1. After the interface is fully displayed, press the function key on the screen to unlock.



If a user has set the a scheduled start up function, when the secduled time arrives, the system will start-up automatically and begin the process of producing steam.

(3) POWRE-OFF





Press the  key to power down the control panel and enter standby mode. During this mode the clock will be displayed on screen.

The system will power-off automatically when the pre-set time is reached. (The system will be shut down after 2 minutes of the steam function closed.)



2. Control of White LED Light (If Equipped)

After power-on, the lighting section interface is shown in Figure 4 as follows: Press  to turn on the light ; Press  to turn off the light.



3. Control of Color Changing Light (If Equipped)



When the system is power-on, enter in the lighting interface as shown in Figure 4: Press  key to turn on the Color-Changing light, and then press   key to change the color of the light. Press the  key to turn off the Colored-light Function after the color-changing light function is started.

4. STEAM FUNCTION





Select the steam interface shown in Figure 1 after power-on: Press  to start the steam function; The steam key is shown as Figure ; Press the  again to stop the steam Function.





Steam temperature setting: Set temperature by pressing the key of "temperature+" or "temperature-". Steam time Settings: Set to 5-60 minutes of steaming in 5 minute steps by pressing the "time+" or "time-" keys.



Save user information: Through the user interface shown in Figure 5; select the user bar to be used by pressing  or  key, then save your temperature and timing by pressing the  button.

To select your setting: Through the user interface shown in Figure 5: Select the setting to be used with the  or  key, and press  to select the saved user setting.



Scheduled start-up setting: Select the function bar of "Working Mode" shown in Figure 6 on the setting interface, press OK key to enter the interface shown in Figure 7 to set relative parameters.

① Time setting: Stop the cursor on the desired "Timing" by using the  or  key, set hours by pressing  key, and minutes by  key. The parameters are set in loop with 1 hour increments and a range of 0-23 hours; And a 10 minute increments and a range of 0-50 minutes.

② Working mode: Move the cursor from Sunday to Monday bar with   key, Then select the function options of: off, one-time schedule, or repeat schedule with   key. If the one-time schedule mode is selected, the system will change the setting to "off" automatically after one-time scheduled cycle is complete.

③ Save information by pressing  key and run as per the set parameters. Exit the setting interface by pressing the  key.

④ When system is running under the scheduled start-up mode, the temperature and steamer working time set by user1 shall be taken as default. For example, if the temperature is 110°F and the working time is 30 minutes set by user1, then the temperature shall be 110°F and the working time shall be 30 minutes under the scheduled start-up mode. If the working time is adjusted after start-up, the scheduled shut off time shall subject to the final set time.

- ⑤ The system will automatically drain the generator 30 minutes after the last use for 5 minutes.
- ⑥ The system can be manually drained by holding the  key after the system has been turned on but steam generation has not started. Holding the  key again or starting up the steam will stop the drainage process. The drainage process will automatically stop when all water is gone.





5.CHANGE BETWEEN FAHRENHEIT & CELSIUS

Selection "F/C" function bar on the setting interface shown in fig.6 after power on, press OK key to enter the interface shown in Figure 9. Press the "OK" key again to shift between degrees Celsius and Fahrenheit.

6. RESTORE FACTORY SETTINGS FUNCTION



Select "Factory Setting" bar on the setting interface, and press the "OK" key shortly to restore the factory parameter. The steam control temperature will return to 110°F and the steaming time to 30 minutes.



7.SET REAL-TIME CLOCK



Select the "Real Time" function through setting interface shown in Figure 6 after power on, and press OK key to enter the interface shown in Figure 8. Move the cursor to the parameters need to be set by pressing   key, e.g.: Hour, minute, date, month, year, displaying time or not after power off etc. Then adjust the parameters by pressing   key. The parameter of "week" will be calculated automatically by date input system. Press the "OK" key to save the parameters set. Exit the interface by pressing "ESC" key. The parameters won't be saved if the "OK" key is not pressed before pressing "ESC" key.

Remarks: The real-time clock shall be recalibrated after they power interruption of the system is more than one week.

8.BLUETOOTH MUSIC FUNCTION

(1) Starting up Bluetooth: Connect your phone or other device to the control panel after power on, select the interface as shown in Figure 3 and press  key to power on/off the bluetooth music function. The key state prompts under play mode are shown as  .

(2) Song switching: When the bluetooth music is playing: It can be switched to the previous song by pressing key  and the next song by pressing  key.

(3) Volume adjustment: The music volume can be adjusted by pressing   key on the interface of bluetooth. The volume range (0-15) e.g. "10dB" may be shown on the screen. It will be recalibrated after they power interruption of the system is more than one week.

(4) The bluetooth connection will be cut off automatically 10 seconds after system power-off. When the cell phone is going to be restarted after 10 seconds, the bluetooth shall be connected through the cell phone, then start the music player to play the music. The bluetooth can be operated normally only after the synchronous success. The bluetooth equipment was named as "sauna".

(5) The bluetooth status indicating icon  will be flash on the bluetooth interface when the bluetooth equipment is not connected, then, otherwise, it will stop flashing.

TECHNICAL PARAMETERS

Working conditions and characteristics				
Rated voltage	AC240/AC220V	Rated frequency	50Hz	
Rated current		Rated power		
Insulation resistance		Waterproof level		
Load the configuration parameters				
Loading	Amount of load voltage	Rated load frequency	Rated load power	Other
Music box	AC100-240V	50Hz	8W*2	
Light	AC12V		< 3W	
Chroma light	DC12V		< 5W	
Solenoid valve	DC12V		5W*2	

INSTALLING LIGHT

CAUTION! Installer must take some moisture proof measures in the process of installation. Electrophorus components cannot be exposed to moisture, as it will cause damage to the light components causing a possible short circuit.

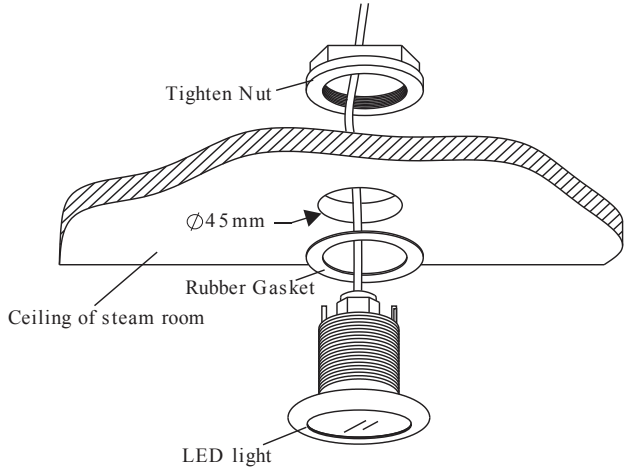

INSTALLING SPEAKERS

1. Chose a proper place on ceiling inside the steam room.
2. Open 4 holes with 5mm depth and 100mm diameter.
3. Fix the speaker and grill on the ceiling with the provided screws as pictured.

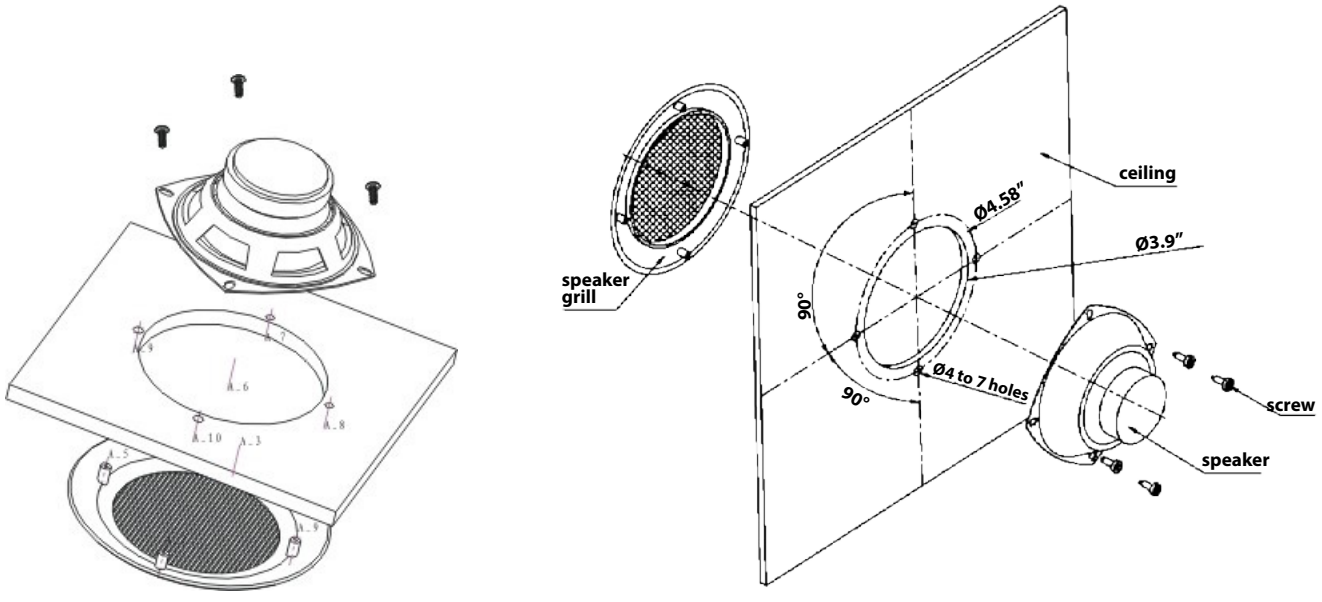

TESTING THE MACHINE

1. Make sure the power switch of the control panel is turned on (the control panel displays ---), and the water supply valve will open.
2. Press the steam switch, , the control panel will display the temperature of the environment, the steam engine begins to input water to start the steam function, and while opening the steam, press the button to open light function.
3. When there is steam output, press again, the steam will stop and the light will go off automatically.
4. Press the button to start the steam, the steam will come out of the steam generator in no more than 1-2 minute. As time goes on, the temperature displayed in the control panel will rise with the temperature in the room before it stops and stays at the set temperature.
5. Based on different requirements of the user for temperature and steam time, the control panel can adjust temperature and steam time.
6. When the set steam time is due, the system will shut off the steam and light function automatically to stop water input and steam production .
7. 30 minutes after the steam is shut off, the system will start drainage automatically for 7 minutes. After testing the machine and it is working properly. Then the machine can be operated normally.

WARNING! Do not dismantle the safety pressure decrease valve arbitrarily.

IMPORTANT! Do not switch the water input pipe when the steam generator is working.

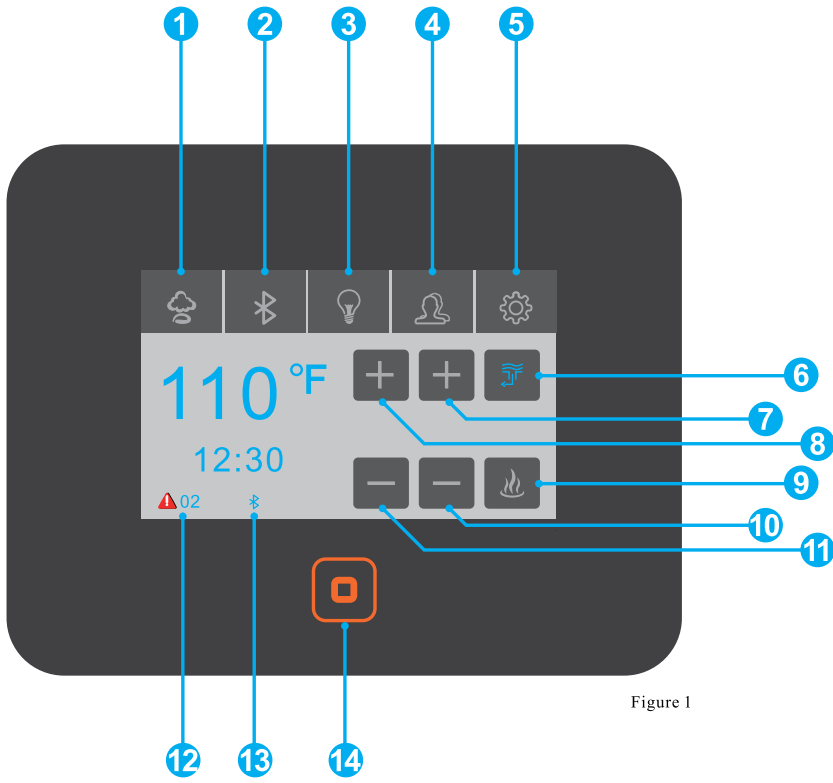

Figure 1

1. Steam Controls
2. Bluetooth Controls
3. Light Controls
4. User Presents
5. Settings
6. Steam Temp +
7. Steam Time +
8. Drain Water
9. Steam Temp -
10. Steam Time -
11. Start Steam Production
12. Error Codes
13. Bluetooth Icon
14. Standby Button



figure1 - main screen

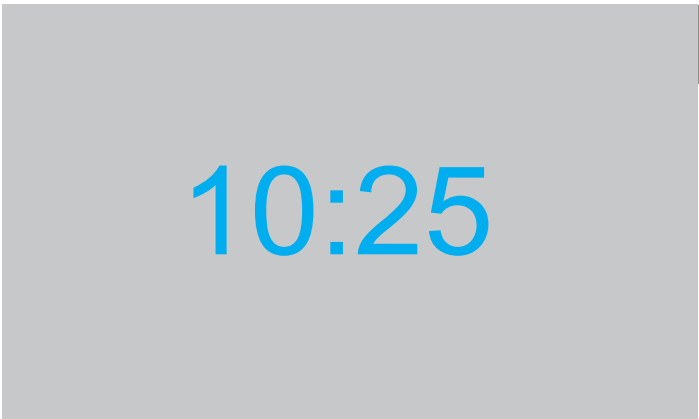

figure 2 - clock screen

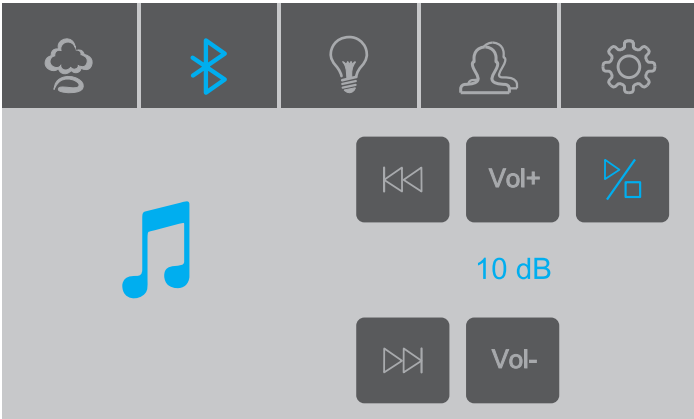

figure 3 - bluetooth screen

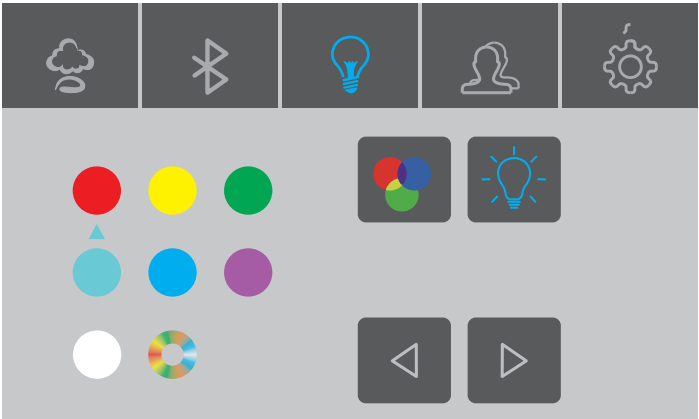

figure 3 - light screen

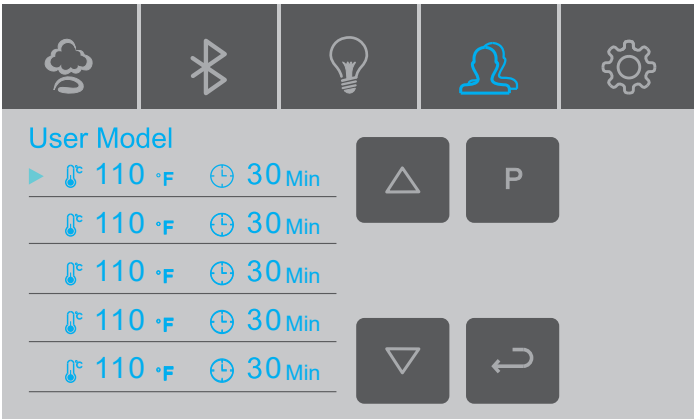

figure 4 - user presents

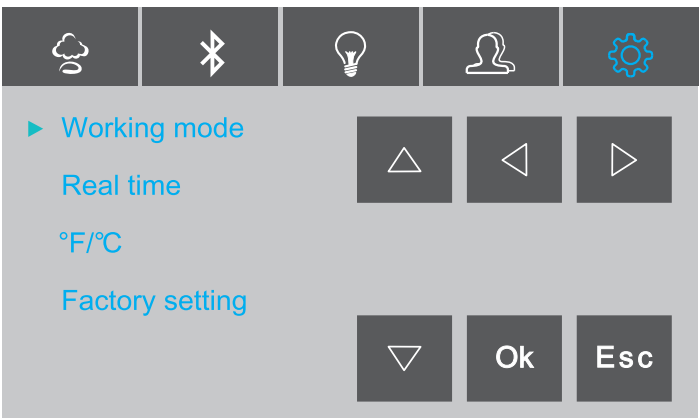

figure 5 - settings

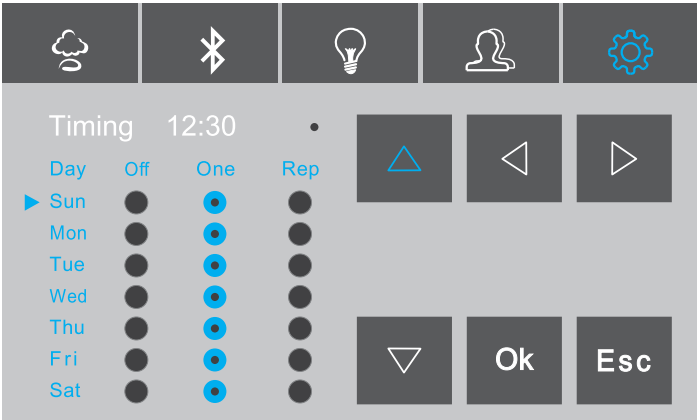

figure 7 - schedule screen

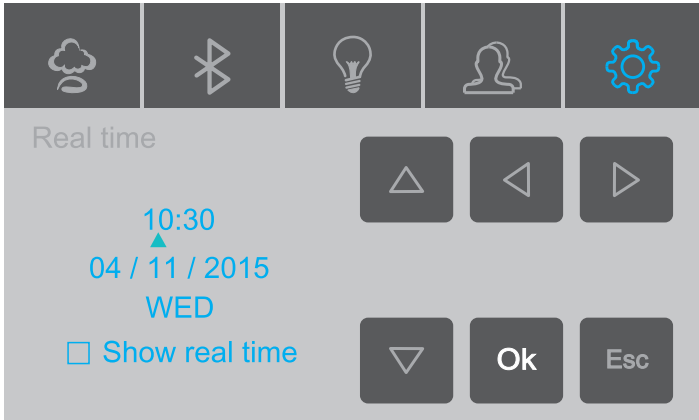

figure 8 - clock settings



figure 9 - temp settings

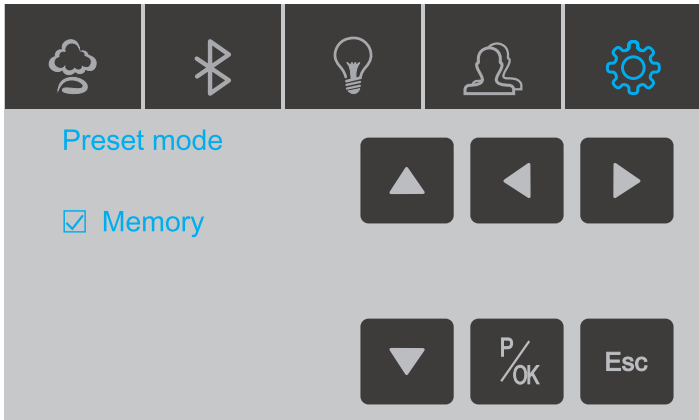

figure 10 - presents mode

STEAM GENERATOR MAINTENANCE

IMPORTANT! The steam generator automatically performs a water discharge operation after each use.

1. Wait for the completion of automatic water discharge after each time using the steam generator to make sure the water in the tank is discharged completely before cutting off power supply.
2. There should not be any leakage or damage among the steam generator, steam nozzle, components and pipes. They should be checked and repaired annually.
3. Clean the water supply pipes of the steam generator once a year.
4. Check all the pipe connections, to ensure wether they are tight and not damaged due to overheat.
5. It is recommended that the water sensor prong gets clean once every six month.

1. Remove the casing of the generator.
2. Locate the water sensor.
3. Label each electrical connections then carefully remove all connections.
4. With a wrench or a 32mm ratchet socket carefully unscrew the water sensor.
5. Thoroughly clean any residue buildup accumulated on the prong.

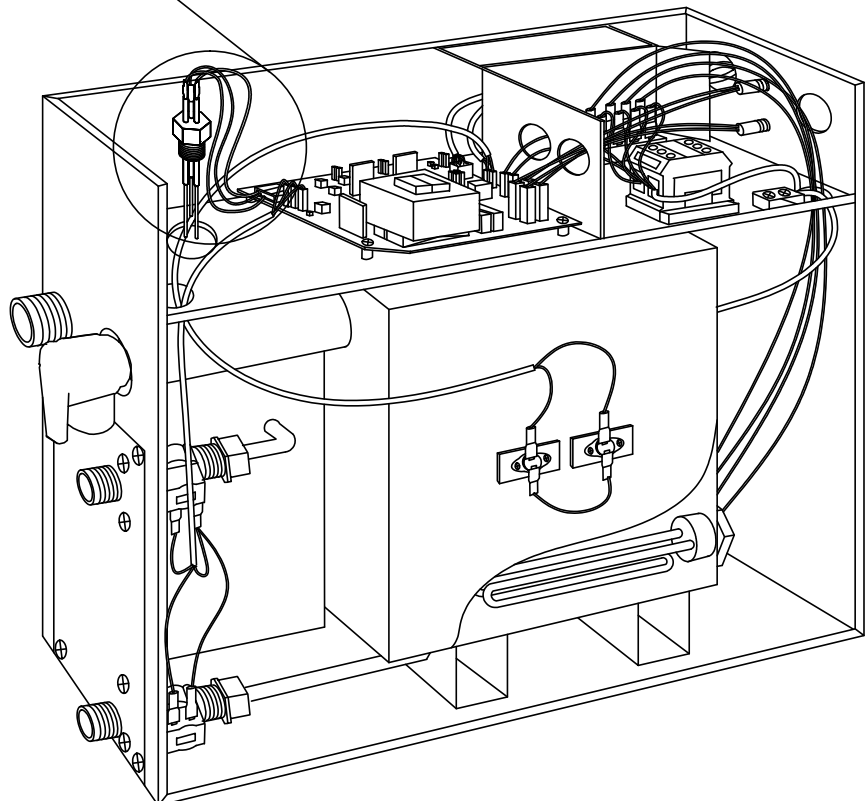
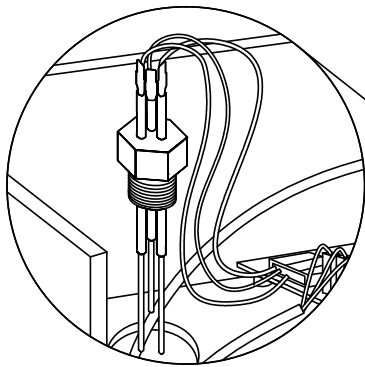

TROUBLESHOOTING GENERATOR

PROBLEM	POSSIBLE CAUSES	SOLUTIONS
The machine does not start when powered	<ol style="list-style-type: none"> 1. Burned out fused 2. The electrical wiring became loose 3. Control panel connection loose 	<ol style="list-style-type: none"> 1. Replace fuse (0.8A/240V) 2. Cut power Supply and reconnect wiring 3. Reconnect control panel and reset Controller (turn off and on) 4. Controller (turn off and on)
Breakers are tripping	<ol style="list-style-type: none"> 1. Check gauge size 2. Damaged heating element 	<ol style="list-style-type: none"> 1. Replace wire with correct gauge 2. Replace heating element
When the machine is started, hot water comes out with little or no steam	<ol style="list-style-type: none"> 1. Check inlet valve 2. Check cable pins 	<ol style="list-style-type: none"> 1. Clean or replace valve 2. Clean or replace pins
The display screen on the control panel does not display anything	<ol style="list-style-type: none"> 1. The control panel wire is not connected properly 2. Trouble with generator motherboard 	<ol style="list-style-type: none"> 1. Check whether the connection plug between the control panel and the generator has become loose, and whether the power circuitry has good contact 2. Replace the motherboard
Water leakage	<ol style="list-style-type: none"> 1. The water pipe connector becomes loose or pipe is broken. 2. Water leakage in the water input valve or the water drainage valve 	<ol style="list-style-type: none"> 1. Tighten the loose connection or change the broken pipe 2. Change the water input valve or the water drainage valve
No steam when starting the machine	<ol style="list-style-type: none"> 1. No electricity 2. No water 3. The set temperature is too low 4. Wiring connection problem 	<ol style="list-style-type: none"> 1. Check the power supply and connections 2. Check the water input pipe and water input valve 3. Reset the temperature 4. Check wiring connection and tighten
The steam does not come out, the water sounds in the machine	<ol style="list-style-type: none"> 1. Check heating element 	<ol style="list-style-type: none"> 1. Clean or replace heating elements
Light doesn't turn on	<ol style="list-style-type: none"> 1. Bad LED light bulb 2. Wiring connection improperly connected or light cable damage 	<ol style="list-style-type: none"> 1. Change LED light bulb 2. Tighten connection or replace light cable
Cold water is coming from the steam head	<ol style="list-style-type: none"> 1. The water sensor cable is loose or water level sensor is defected 2. Check cable pins 3. Check inlet water valve 	<ol style="list-style-type: none"> 1. Make sure that the water level cable isn't loose if the cable is well connected replace the water sensor 2. Replace cables 3. Clean or replace inlet valve
05 Error Code	<ol style="list-style-type: none"> 1. Water inlet problem 	<ol style="list-style-type: none"> 1. Check water supply for proper flow 2. Check inlet valve for blackage. It many need cleaning or replacement.

TECHNICAL PARAMETERS

Type	4.5KW	6KW	7.5KW	9KW	10.5KW	12KW
Power (KW)	4.5	6	7.5	9	10.5	12
Voltage (V)	240	240	240	240	240	240
Current (A)	19	25	32	38	44	50
Errors Range	+10%	+10%	+10%	+10%	+10%	+10%
Anti-Static Constant	>1500V	>1500V	>1500V	>1500V	>1500V	>1500V
Insulation Resistance	>20M Ω	>20M Ω	>20M Ω	>20M Ω	>20M Ω	>20M Ω
Head Lamp	~12V/3W	~12V/3W	~12V/3W	~12V/3W	~12V/3W	~12V/3W
Time Set Range (min)	1-60	1-60	1-60	1-60	1-60	1-60
Steam Press (psi)	3	4	4	4	5	5
Steam Vol. (cu. in./min)	9	11	13	16	19	21
Steam Spray Time (sec)	100-180	180-240	150-210	120-180	170-230	150-160
Water Vol. (cu. in.)	80	160	160	160	330	330
Applicable Space of the Room (cu. ft.)	90	150	225	300	400	450

IMPORTANT! The list above is for reference only. Actual checking and repairing should be based on national and local codes, ask professional service personnel to operate.

IMPORTANT! The parameter listed above will vary by geographical location and environment. Please consult a qualified designer and architect for more detailed use.

INSTALLATION & USER GUIDE

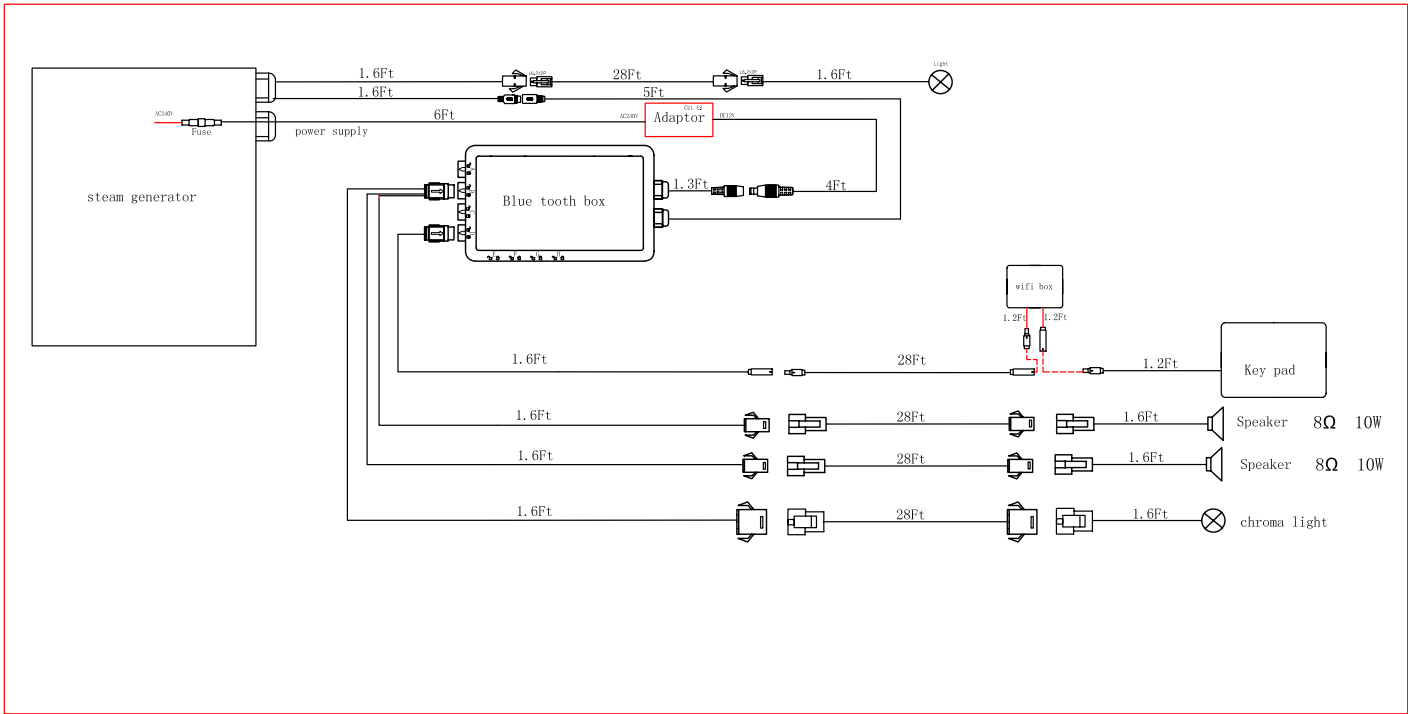

STEAM SPA TROUBLE SHOOTING

Generator Maintenance and Service should be completed by Licensed Plumber or Electrician

Turn Off Electrical Breaker and Water Supply Before Any Work On Electrical Connection is attempted

UNIT LEAKING WATER OUT OF THE STEAM OUTLET:

- **PSI TO UNIT GREATER THAN 15-20PSI:** Confirm that the PSI going to the unit is regulated between 15-20 PSI (Most House Lines Run Off approx. 50-100, (a Pressure Regulating Valve may be required).
- **WATER SENSOR IS DEFECTIVE:** (New Generator/Elements): Remove heating elements and check for corrosion/burn out of element.
- **SEDIMENT STUCK IN LINE:** Remove threaded line to water intake. Remove Screen before the solenoid valve and check for sediments. If sediment found look into adding or replacing the filter and removing sediment.

MY CONTROL IS NOT TURNING ON:

(To test, plug control panel directly into the Generator via the shorter 1 ft. cable) ***Turn Off Breaker Before Any Work On Electrical Connection is attempted***

- **BREAKER IS NOT TURNED ON:** Have the customer check if the breaker has been turned on for the unit.
- **LOOSE CONTROL PANEL CABLE CONNECTION:** Check to see if “XYZ” arrow on the connection are lined up and plugged into each other completely. The wires need to snap completely in, to where there is no space between both sides of the connector
- **WIRE GAUGE FOR ELECTRICAL CONNECTION INCORRECT:** Check the gauge of wire installed, and compare to the “Ampere Meter” chart on pg. 13 of the manual, to ensure correct gauge wire is being used.
- **AMPERAGE NOT SUFFICIENT:** Check breaker size against the “Ampere Meter” chart on pg. 13 of the manual. If breaker is not sufficient, the breaker will need to be changed.
- **VOLTAGE NOT SUFFICIENT:** Ensure that the generator is connected 240v electrical supply.
- **DAMAGED 1FT. CONTROL CABLE:** Have customer check the pins at the male connection coming from the back of the generator. If pins look to be okay, remove lid to see if connection made at terminal block is loose. If so press connection in completely.
- **DAMAGED CONTROLLER EXTENSION CABLE:** Look at the male and female end of the 20ft extension. Check if there is visible damage to the pins and connection, or if any pins are missing from the male end of the cable.
- **LOOSE CONNECTION AT TERMINAL BLOCK:** Make sure all connection made at the terminal block are inserted and tightened securely.
- **BROKEN FUSE HOLDER:** Unscrew top panel and look at fuse connections. If any damage seen to the fuse holder or connection.
- **FUSE HAS BURNT OUT:** Unscrew fuses (2 black rubber screws located on the exterior of the generator in-between the electrical connection and control panel connection cable). Look to see if fuse wire is broken or dark residue on inside of fuse.
- **MOTHERBOARD MALFUNCTION:** please contact Technical Support to request new Motherboard.

CONTROL PANEL READING E1 (CONTROL CONNECTION) ERROR:

- **CONTROL CABLE CONNECTION LOOSE:** Confirm that control cable connections are tightly made by pressing together firmly at xyz connections.
- **CONTROL CABLE PINS BROKEN:** Confirm that the cable connections are intact and no pins are missing from the generator to extension connection or the extension to control panel extension.
- **LOOSE SHORT CONTROL CABLE:** Remove the top of the unit. Then look to see where the large grey wire runs to the mother board. Press down on white connection and snap into place.
- **DAMAGE TO CONTROL PANEL CONNECTIONS:** Inspect the grey cable that runs from the motherboard to the control panel inspecting the 3 Cables. (1 ft. Generator Cable, 20 ft. Cable Extension, and the grey Control Panel Cable) , looking for kinks in the line where wiring could have broken.
- **LOOSE RELAY CONNECTION:** Check to see if all connections are completely secured on the motherboard and connection points. If any are loose, secure connection.

STEAM SPA TROUBLE SHOOTING

CONTROL PANEL READING EO (WATER LEVEL) ERROR:

- **WATER PRESSURE NOT SET CORRECTLY:** Confirm that the PSI going to the unit is regulated between 15-20 PSI (Most Homes can have approx. 50-100psi).
- **FLOW TO UNIT NOT REDUCED:** Reduce flow of water by closing shut-off valve on water intake line to 20% open and 80% closed.
- **WATER LEVEL SENSOR CONNECTION IS LOOSE:** Remove top panel of generator and check to see if there are loose connections on the water level sensor by removing rubber cover. If so snap into place and replace rubber cover.
- **WATER LEVEL SENSOR HAS SEDIMENT OR CALCIUM BUILDUP:** Remove Water level Sensor and check for corrosion/buildup. If there is build-up on the sensor prongs, soak for approx. 15-20 min in vinegar then wipe off the residue buildup. If the sensor is corroded, contact Technical Support to request a new Water Level Sensor.
- **SEDIMENT STUCK IN LINE:** Remove threaded line to water intake connection. Check inside of the inlet connection for sediments. If sediment found look into adding or replacing the filter and removing sediment from the inside of the connection. (Water inlet valve may need to be removed from generator for service)

GENERATOR TRIPS BREAKER:

- **INSUFFICIENT VOLTAGE:** Confirm that Voltage to the unit is 208v/220v/240v.
- **INSUFFICIENT AMPERAGE:** Confirm that Amperage to the unit sufficient (max output + 20%)
- **IMPROPER GAUGE WIRE:** Confirm gauge of wire for the electrical connection to the unit. If it is larger than the required size decrease until you are at the recommended gauge or lower.

CONTROL PANEL ON WITH NO FUNCTION:

- **CONTROL CABLE PINS BROKEN:** Confirm that the cable connections are intact and no pins are missing from the generator to extension connection or the extension to control panel extension.
- **CONTROL CABLE CONNECTION IS LOOSE:** Confirm that control cable connections are tightly made by pressing together firmly at xyz connections.
- **LOOSE RELAY CONNECTION:** Check to see if all connections are completely secured on the motherboard and connection points. If any are loose, secure connection.
- **DEFECTIVE MOTHERBOARD:** Faulty motherboard. Faulty motherboard; please contact Technical Support to request new Motherboard.

DECREASED STEAM PRODUCTION/ NO STEAM PRODUCTION :

- **HEATING ELEMENTS ARE CORRODED/DAMAGED:** Remove top, side, and small back access panels. Disconnect leads from the heating elements and remove the elements from the generator, and inspect the elements for corrosion or damage.
- **HEATING ELEMENTS HAVE CALCIUM OR SEDIMENT BUILDUP:** Remove top, side, and small back access panels. Disconnect leads from the heating elements and remove the elements from the generator, and inspect for build-up. Soak for approx. 15-20 min in vinegar then wipe off the residue buildup. (Buildup on elements a sign that the filter may need to be changed or added)
- **FILTRATION TO THE UNIT HAS NOT BEEN CHANGED:** Customer has not changed the filter to their unit in the recommended time frame (provided within our warranty policy). Remember that heating elements do vary depending on the wattage of the unit.
- **LOOSE WIRE CONNECTION TO HEATING ELEMENT:** Remove the panel underneath the electrical connection and the control panel power cable. Look to see that connection made at element are both properly and securely made.

STEAM BATH GENERATOR USER GUIDE

