

Steambath Generators

Model: TSG-12 & TSG-15



Important: Locate Publication No. 199 "Steam Bath Important Safety Instructions". This publication includes a Warning label that the contractor must install on the wall near the entrance to the steam room in a highly visible location. This label and its additional safety information are packaged with the generator in the envelope containing the installation instructions. If it is lost or missing contact Steamist (201-933-0700) for a replacement Publication No. 199. This publication along with all documents must be left with the owner.

The Steamist "TSG" Generator comes factory assembled, carefully wired and tested.

The Plumbing Installation must conform to local and national codes. All electrical power should be turned OFF when working with Steam Generator.

1. Pre-Installation

- a) Be sure that the proper size Steam Generator has been selected by using the sizing page in the "Full Line Brochure," "Pricing Guide," "The Generator Sizing Guide," "Architectural Guidelines," or in the Residential Systems/Steambath Product Information section of the Steamist website - www.steamist.com.

CAUTION: An improperly sized Steam Generator may NOT produce the amount of steam necessary to reach selected temperature.

- b) For optimum performance, the Steam Generator should be located as close as possible to the Steamroom, Shower or tub enclosure using a 3/4" copper pipe (1/2" copper pipe is also acceptable, but not preferred). If the steam pipe exceeds ten feet, it should be insulated using appropriate pipe insulation rated for a minimum of 212° F. Maximum steam pipe distance should not exceed a total of fifty linear feet. Refer to Installation Suggestions on page 4.

CAUTION: Do NOT install near flammable material such as paints, thinners, gasoline, etc.

CAUTION: Steam generators must NOT be installed outdoors, in moist, humid areas, in areas prone to freezing, or extreme heat such as an unventilated attic. To do so will void the warranty.

- c) The steam line and safety valve reach a temperature of 212°F during operation and should be appropriately protected to prevent personal injury by accidental contact.

2. Plumbing Rough-in

Plumbing is required for the water supply and steam line this should be completed before the walls are closed. For operation, the "TSG" Steam Generator requires a 3/8" O.D. copper tubing to the fitting on the Generator for water inlet and a 3/4" copper or brass pipe for steam outlet.

NOTE: Safety Valve should be connected to a minimum 3/4" indirect waste or as required by local plumbing codes. In the unlikely event this valve should open, the discharge must be directed to prevent damage to the home.

- a) **Water Inlet** - Rough in a water line, 120 PSI max, to the hot or cold supply. A shut off valve with a 3/8" connection to the steam generator is to be provided at the generator location (see Figure 4 on page 3).
- b) **Steam Outlet** - Rough in the steam line using a 3/4" copper or brass pipe; do NOT use black iron or galvanized pipe; it will rust and discolor the wall of the steambath. Do NOT use any plastic type pipe or fittings. The steamhead location should be 12" to 18" above the shower floor or 6" above the rim of the bathtub, as far from the seating area as possible.

CAUTION: No shutoff valve can be installed in the steam line. Do NOT create traps or valleys in this line which would trap condensation and block the flow of steam. The steam pipe should be pitched allowing condensation to run back toward the Steam Generator (preferred), or toward the steamhead. When installing multiple steam generators DO NOT interconnect the steam pipes.

Figure 1- Steam Generator

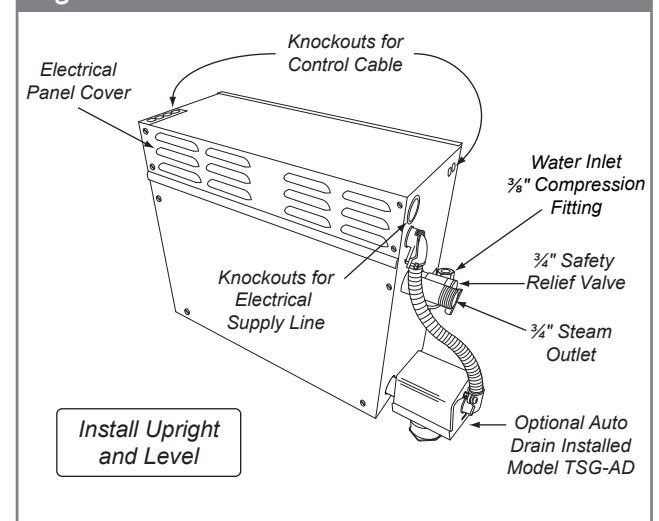

IMPORTANT: The warranty of this product is voided if it is used in a commercial application or for anything other than a residential steambath installation.

Installation Instructions

Model: TSG-12 & TSG-15

3. Steam Generator Installation

The Steam Generator should be mounted in a location convenient for hook-up and service by the plumber and electrician.

CAUTION: The Steam Generator is designed to be used ONLY in an upright and level position; to do otherwise would damage the unit and void the warranty.

a) The Steam Generator can be mounted to a wall or set on the floor. However, the unit must be secured. To secure the unit to a vertical wall, loosen the two screws holding the electrical access cover, remove cover (see Figure 1). Located inside the cabinet near the top left and right corners are mounting holes. Place top cover back and secure.

b) Connect the 3/8" water inlet to a shut off valve as described in Section 2.a. The valve must be kept in an open position during normal operation. In an area where water hammer is a problem install a water hammer arrestor in the line. Refer to Figure 2.

IMPORTANT: Do NOT use a "saddle valve" or piercing type valve for water connection.

c) Connect the steam line from rough-in location described in Section 2 to the 3/4" nipple on the Steam Generator using a union.

Figure 2 - Plumbing Diagram

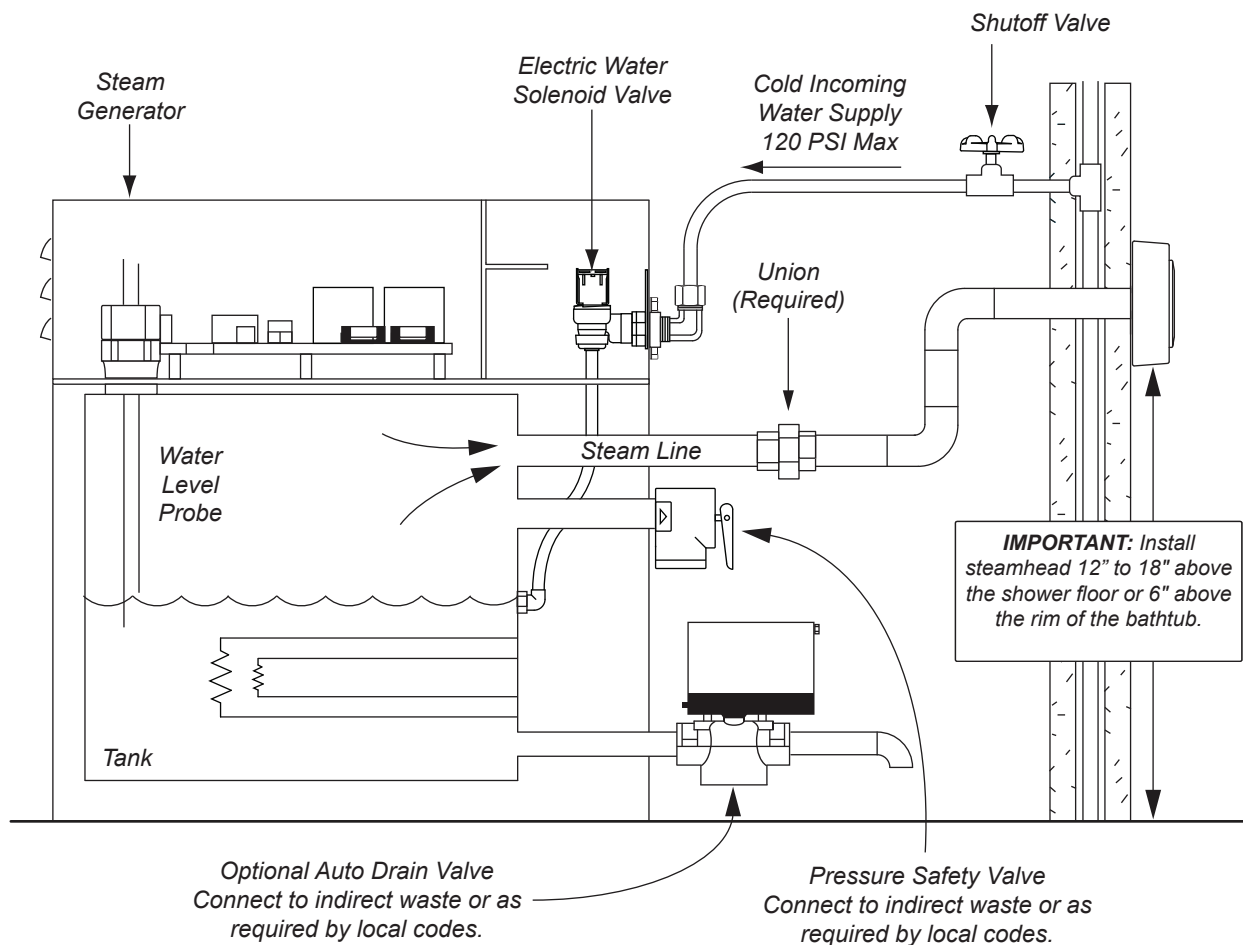
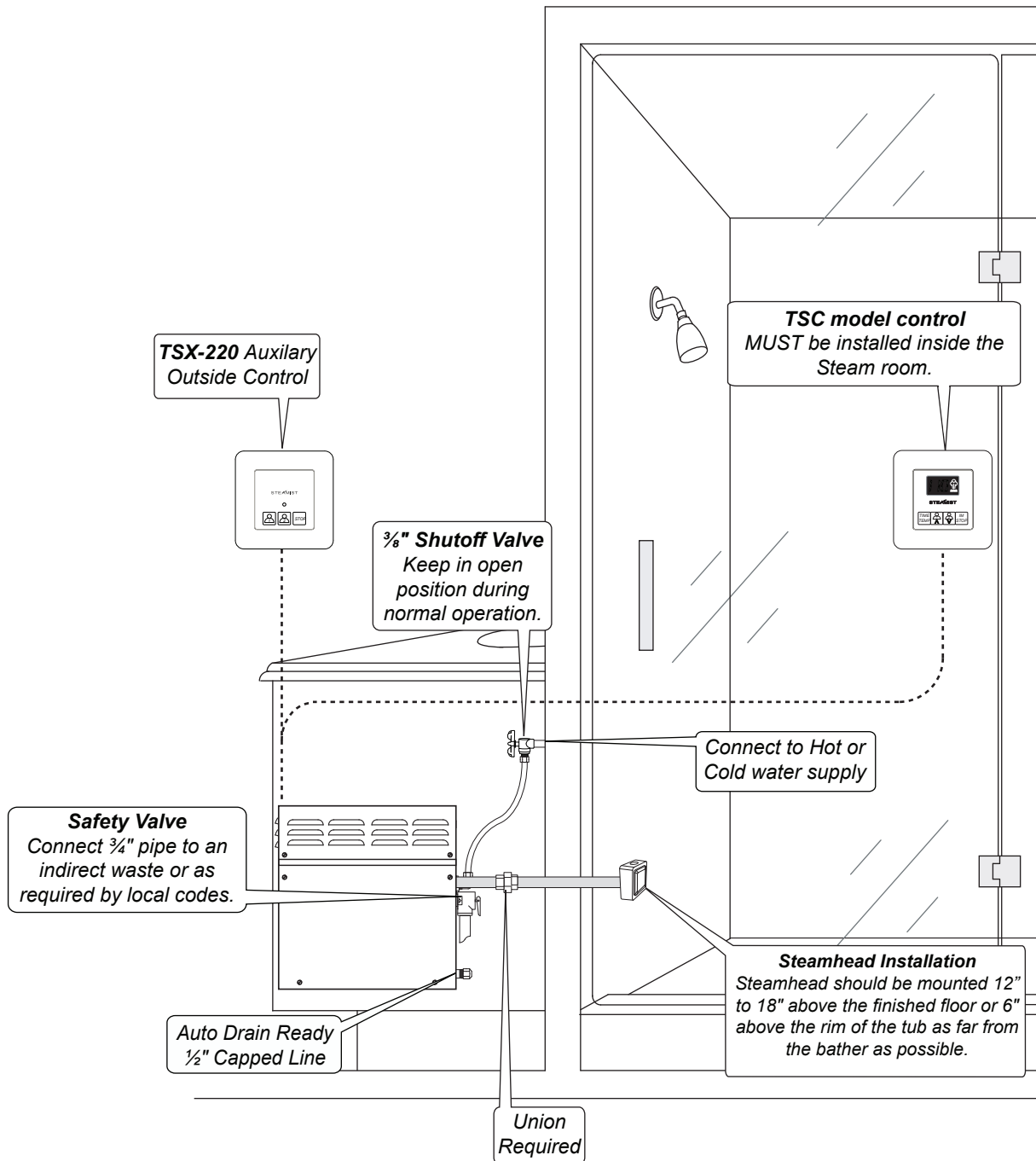

Figure 4 - Typical Installation

Model: TSG-12 & TSG-15

The Plumbing Instructions must be given to the homeowner for future use.



Steam Outlet Pipe - Use a 3/4" Copper or Brass pipe.

CAUTION: Do NOT install a shutoff valve on the steam outlet pipe. Do NOT create traps or valleys in this line which would prevent the flow of steam. The steam outlet pipe should be pitched toward the Steam Generator (preferred), allowing condensation to run back into the Steam Generator or toward the steamhead. If the steam pipe exceeds ten feet, use an appropriate pipe insulation rated for a minimum of 212°F.

Access Requirements

Model: TSG-12 & TSG-15

Select a location for mounting the Steam Generator that is accessible for installation and service. The access requirement indicates the minimum space for convenient access to Steam Generator.

CAUTION: All models must be installed INDOORS, in a DRY, NON-FREEZING location away from flammable materials such as: Gasoline, Paints, Thinners, Etc.

IMPORTANT: Steam Generator must be installed upright and level. The serial number info should be visible and the Steam Generator should be accessible for service.

Figure 5

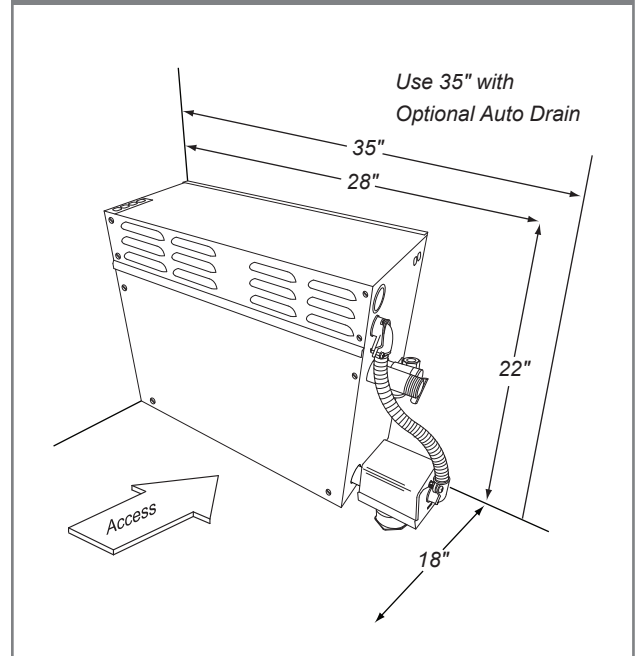

Installation Suggestions

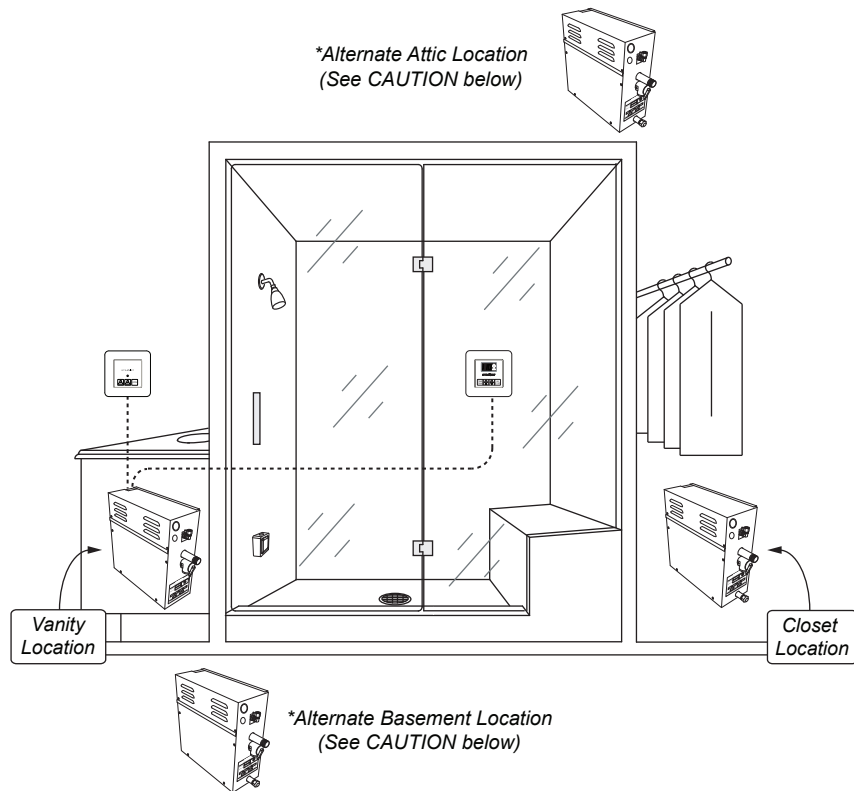

***CAUTION:** Steam generators must NOT be installed outdoors, in moist, humid areas, in areas prone to freezing, or extreme heat such as an unventilated attic. To do so will void the warranty.

Steambath Control

Model: TSC-450



Important: Locate Publication No. 199 "Steam Bath Important Safety Instructions". This publication includes a Warning label that the contractor must install on the wall near the entrance to the steam room in a highly visible location. This label and its additional safety information are packaged with the generator in the envelope containing the installation instructions. If it is lost or missing contact Steamist (201-933-0700) for a replacement Publication No. 199. This publication along with all documents must be left with the owner.

Control Features

1. Timer control
2. Temperature control
3. Multiple user settings
4. AudioSense™ control
5. ChromaSense™ control
6. AromaSense™ control
7. ShowerSense™ control
8. Other Miscellaneous settings

NOTE: For more details see separate operating instructions.

IMPORTANT: Control **MUST** be installed inside the steam room for proper operation of the system.

Total Sense Touch Control



Cleaning Instructions: Use a damp cloth and mild soap. Do NOT use abrasive cleaners which might scratch the surface or the base of the control.

Installation Instructions

1. Pre-Installation - Control Location

The TSC-450 Control must be installed inside the steam room. For convenience the recommended height from the floor is four feet. If a TSSH is also installed we recommend a height of 4½" feet when used for both steam and shower. Provide a 1½" hole in the wall at this location (see Figure 1).

IMPORTANT: Multi-conductor cable must be installed so that the end will not be buried inside the wall. The unit will

not operate unless the control is installed.

2. Electrical Rough-in

Remove the multi-conductor cable from the control packing box. Carefully route the multi-conductor control cable from the steam generator to the TSC-450 located inside the steamroom (see Figure 1). Route multi-conductor cable through a ¾" conduit to protect the cable from damage and to facilitate replacement if necessary.

Figure 1

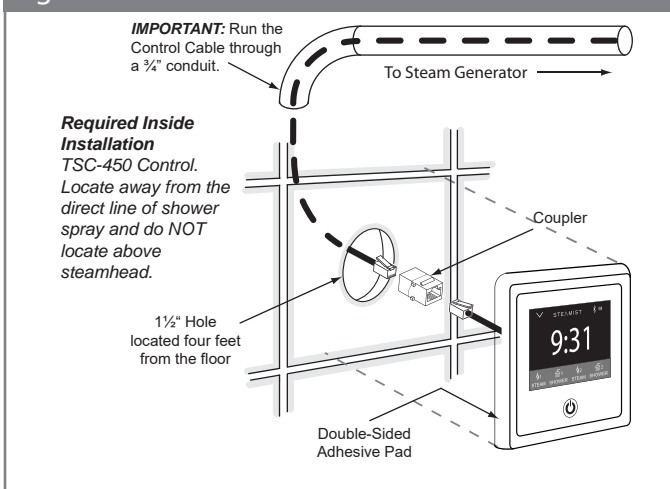
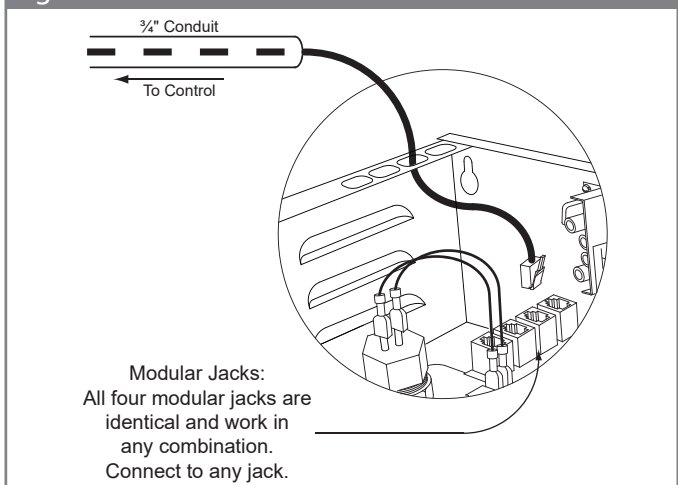

Figure 2 - Cable Installation on Generator



IMPORTANT: The TSC-450 Control will only function with the current TSG steam generators.

3. Control and Cable Installation

- Locate the previously installed cable and black plastic strain relief clamp which is in the control packing box. Locate the knockout on the steam generator for the control cable (see Figure 2).
- Place strain relief around cable about seven inches from the end and insert into the hole. Remove the protective covering labeled "Remove Before Installation" from the modular jack found on the PC board.
- Remove the protective cap from the multi-conductor cable plug. Connect the cable to the modular jack.
- Close and secure generator cover.
- Locate Telco Jack at female coupler, on back of the TSC-450 control. Remove the protective covering labeled "Remove Before Installation". Remove protective cap from cable and plug into jack. Check that the orientation of the plug properly aligns with the jack. A snap will indicate the plug is installed correctly (see Figure 3).

WARNING: Test the control for operation before continuing on to the next step.

- Peel adhesive liner from back of the control. Apply silicone (supplied) into channel around the back of the control to form a watertight seal (see Figure 3).
- Apply the control to the wall. Press firmly and hold for a few seconds. Wipe the excess silicone from around the control.

The TSC-450 Touch Control has a built in temperature sensor and therefore must be installed inside the steam room.

Temperature settings: 60°F min to 125°F max
Max Time setting: 60 Minutes

Figure 3

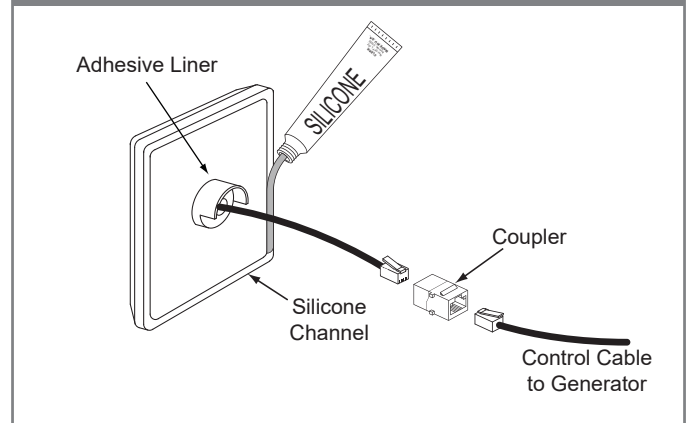

Figure 4



IMPORTANT: The adhesive on the back of the TSC-450 control will NOT seal this control. It is the responsibility of the installer to seal this control to the wall with the supplied silicone. Water damage to the control is not covered by the warranty.

Figure 5 - Installation Suggestions

