

STEAMIST®

Steam Generator

Models: TSG-7 and TSG-10

Features

Limited lifetime warranty - 2-year in home labor warranty where available

Selectable "Instamist"

Proportional Steam

Steady Steam

"Gangable" up to (4) generators

Microprocessor based diagnostics and LED indication

Stainless Steel Tank Construction

Intelligent control communication

UL/CUL Listed

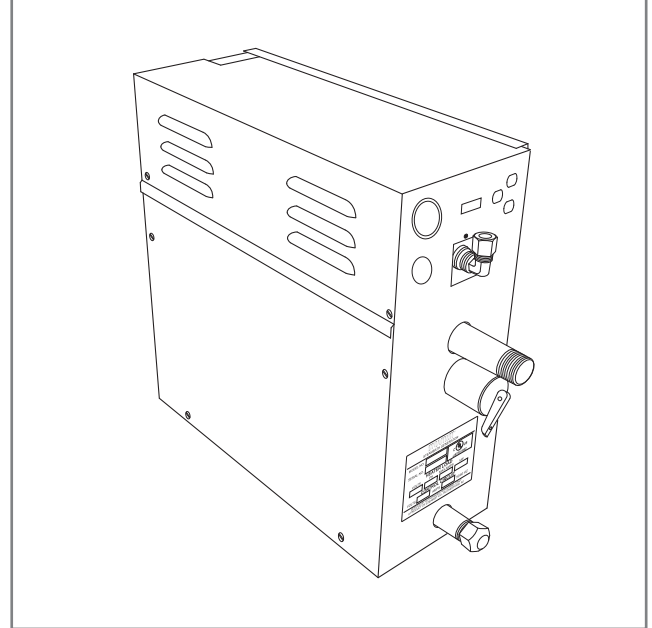

Steam Generator Specification Chart

Product Number	KW Rating	*Max. Cu. Ft. Range	Volts/Phase/Max. Amps	Line Fuse	Dimensions L x W x H
TSG-7 TSG-7-208 TSG-7-208/3	7.5	250	240/1/31 208/1/36 208/3/21	40 50 30	15" x 6" x 15.5"
TSG-10 TSG-10-208 TSG-10-208/3	10	450	240/1/42 208/1/48 208/3/28	50 60 40	15" x 6" x 15.5"

* Refer to sizing guidelines to accurately determine the proper size generator for the installation.
90°C copper wire is required for generator connection. Installation shall be in accordance with NEC and local electrical codes.

Required Equipment

TSC Model Control

Required Electrical Service

Dedicated circuit required: See Specification Chart for proper electrical requirements

Product Information

Water Supply - 3/8" Compression Fitting, 120 PSI Max

Steam Outlet - 3/4" Brass NPT male thread

Pressure Relief Valve - 3/4" NPT female thread

Drain Outlet - Capped 1/2" Brass NPT male thread

Supplied with a 35' control cable

Generator

Weight - 30 lbs.

Installation Notes

For optimum performance, the steam generator should be mounted as close as possible to the steam room. If needed, the steam pipe may be up to 50' long.

Steam Generators should be accessible for service.

Do NOT install near flammable material such as paints, thinners, gasoline, etc.

Steam generators must NOT be installed outdoors, in moist, humid areas, in areas prone to freezing, or extreme heat such as an unventilated attic. To do so will void the warranty.

Steamhead to be mounted 12" to 18" above floor or 6" above rim of tub and as far from the seating area as possible.

Service Access

Minimum: 21" L x 20" W x 22" H (28" L with Auto Drain)

Dimensional Drawing

Models: TSG-7 and TSG-10

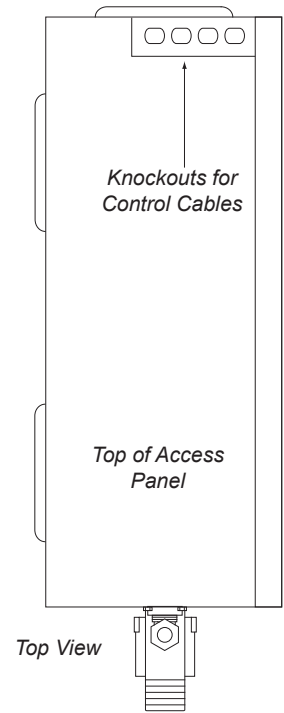
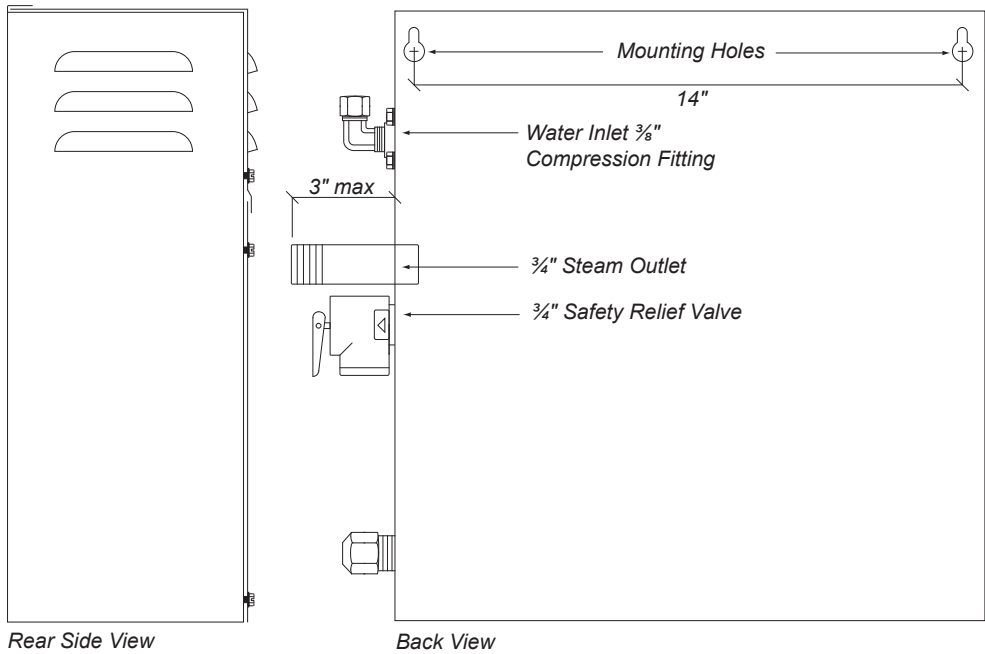

*Add 1/4" to the dimension for the louvers

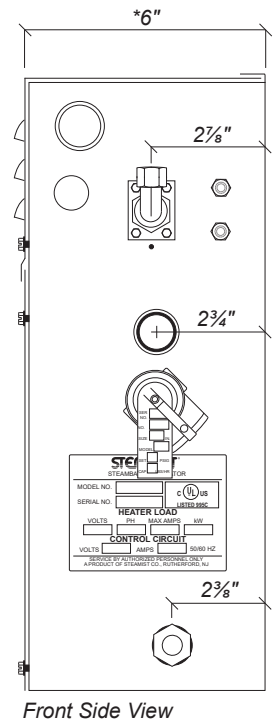
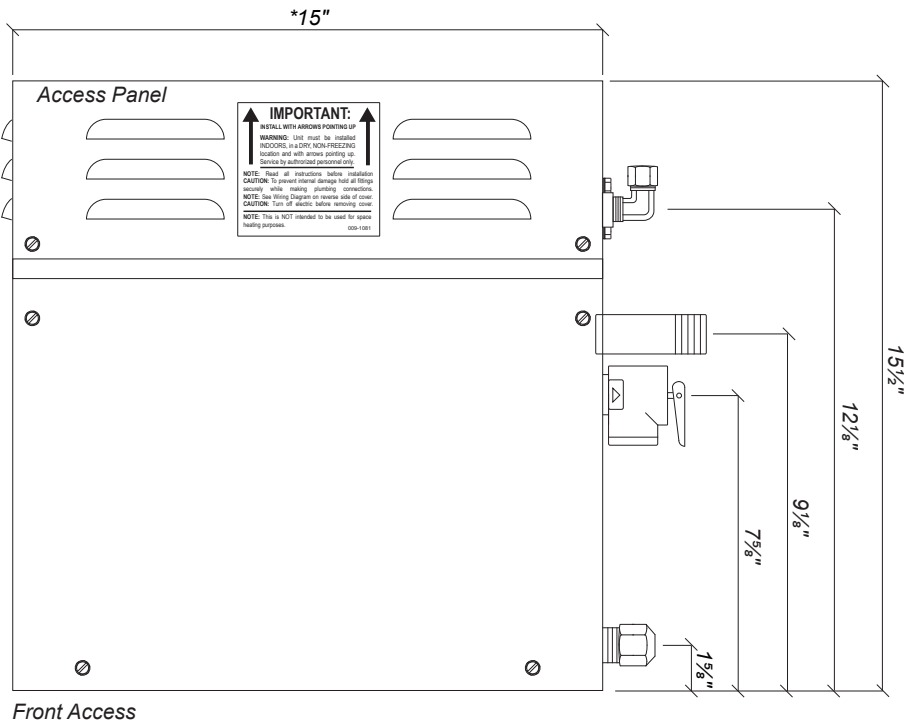

STEAMIST®

Steambath Control

Model: TSC-450

Product Information – TSC-450 with WiFi

2 years parts warranty

Finger-light touchscreen operation

2 memory settings

Programmable Time and Temperature.

Temperature range 50°F min to 125°F max.

Time up to 60 minutes.

Operates AromaSense, AudioSense, ChromaSense and ShowerSense options.

Digital display of ambient and set temperature.

Dimensions: 4½" x 4½"

Package Includes: Control, 6-Pin Coupler, Steamhead (Delivers 360-Degree Steam Dispersion), Strain Relief Clamp, Silicone Sealant, Installation and Operating Instructions.

Required Electrical Service:

Low-voltage connection from TSG generator via multi-conductor cable (supplied with Steam Generator).

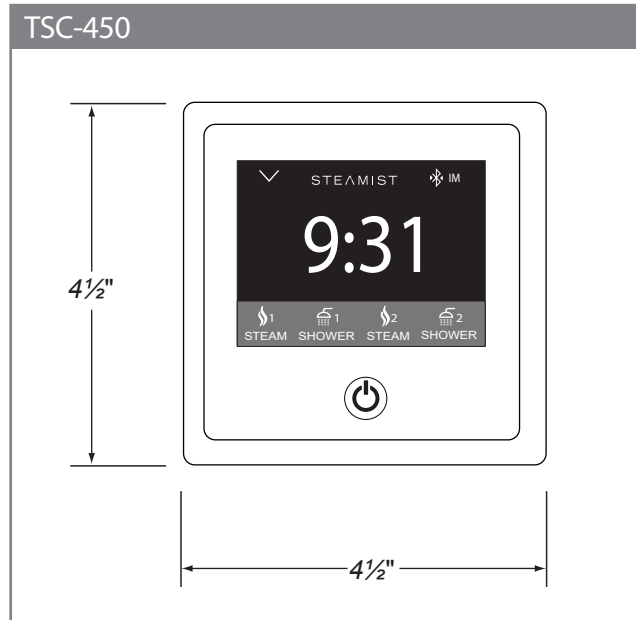

Notes

Installation Notes:

Surface Mount - 1½" hole required.

Must mount inside the steam room.

Steamist recommends that the multi-conductor cable be run through ¾" conduit to protect cable from damage and to facilitate easy replacement.

Mount control near seating area and not above steamhead.

Rough-in Notes:

Control should be mounted 48" above the floor.

Steamhead to be mounted 12" to 18" above the finished floor or 6" above the rim of the tub and as far from the seating area as possible.

Product No. - Finishes:

Contemporary

450-PC - Polished Chrome

450-PN - Polished Nickel

450-BN - Brushed Nickel

450-BB - Brushed Bronze

450-PG - Polished 24K Gold

450-ORB - Oil-Rubbed Bronze

Traditional

450T-PC - Polished Chrome

450T-PN - Polished Nickel

450T-BN - Brushed Nickel

450T-BB - Brushed Bronze

450T-PG - Polished 24K Gold

450T-ORB - Oil-Rubbed Bronze

Package Contents

Strain Relief Clamp

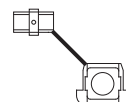

Silicone Sealant

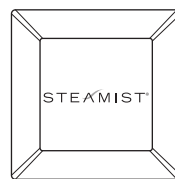

360-Degree Diffusing Steamhead

6-Pin Coupler



Wiring Layout with Spa Options

Model: TSC-450

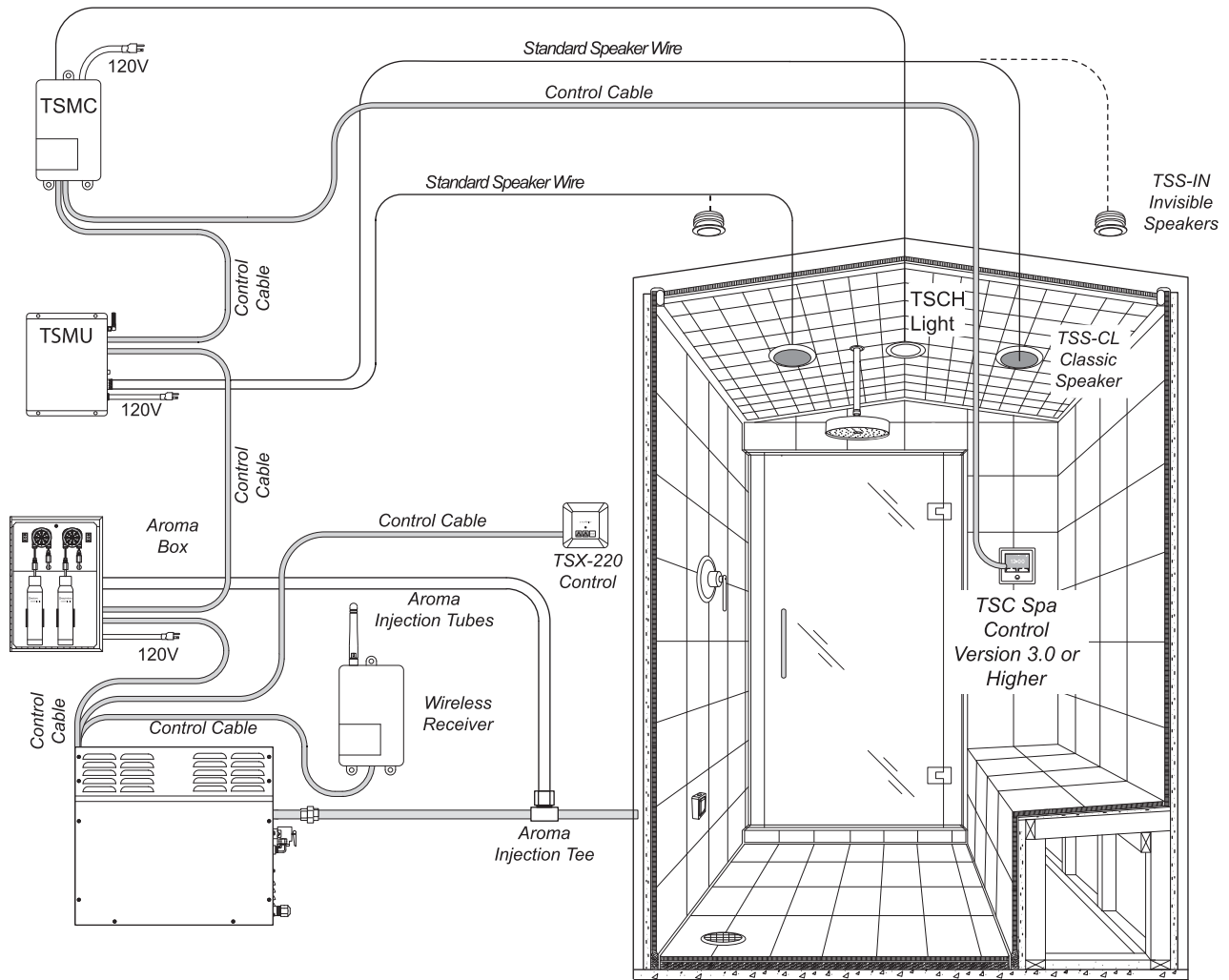

Shown with other Spa Options