

Instructions for Models:

S-3023

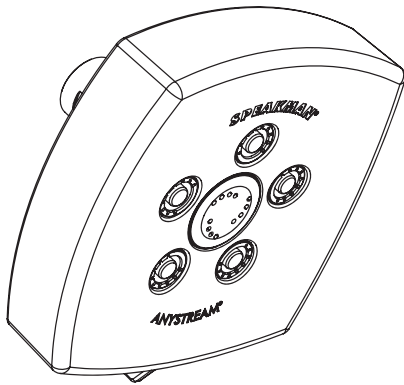

Need Help?

For additional assistance or service call:

SPEAKMAN Company
400 Anchor Mill Road
New Castle, DE 19720

PHONE: 800-537-2107
EMAIL: customerservice@speakmancompany.com
WEB: www.speakmancompany.com

92-S-3023-R1

What You Need To Know:

Tools:

Required:

*Teflon Tape

*Adjustable Wrench



Important Notes:

Be sure to read instructions thoroughly before beginning installation. Do not overtighten any connections or damage may occur.

Safety Tips:

Cover your drain to prevent loss of parts.

Maintenance:

Periodic cleaning using a mild soap and warm water will help keep your showerhead's appearance in its original condition.

For best results, dry immediately with a soft, clean cloth. DO NOT USE harsh and/or abrasive cleaners.

To help restore the finish, occasionally apply a non-abrasive wax to your showerhead body (follow manufacturers' instructions).

On CHROME PLATED SHOWERHEADS, a two (2) part white vinegar, one (1) part water solution can be used to break down excessive mineral deposits on the sprays. Let the showerhead soak in the solution for about ½ hour then rinse thoroughly. Brush off any remaining mineral deposits if necessary.

DO NOT USE the vinegar/water treatment on all special finishes (-BN, -ORB, -PN, -PB).

To reduce mineral build-up, turn the handle to FLOOD position to let the water drain out after every use.

Warranty:

Warranty information can be found at: www.speakmancompany.com

- 1 Apply Teflon Tape to the outlet side of shower arm in a clockwise direction.

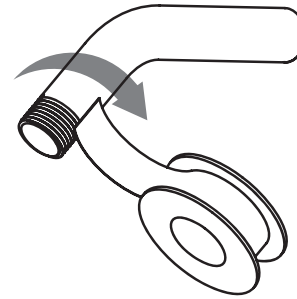

- 2 Thread Showerhead onto shower arm by turning it in a clockwise direction. Tighten with adjustable wrench. Turn water supply on and check for leaks.

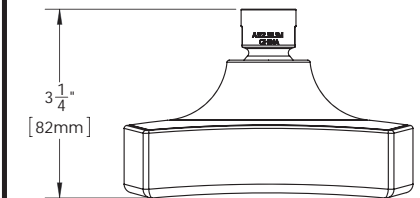
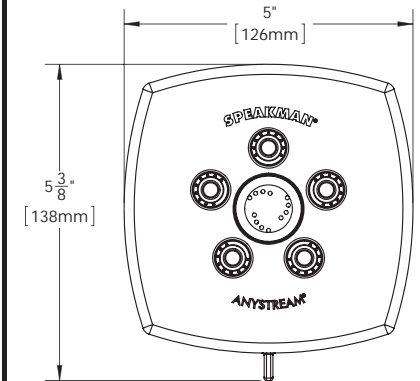
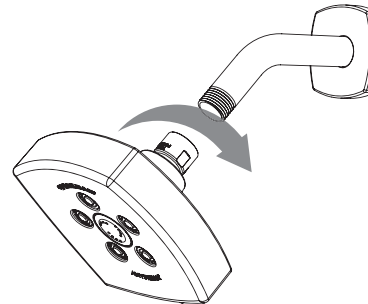

Specifications:

Inlet: 1/2" NPT FEMALE