

Instructions for Models:

SB-1031
SB-1031-BN
SB-1031-PN

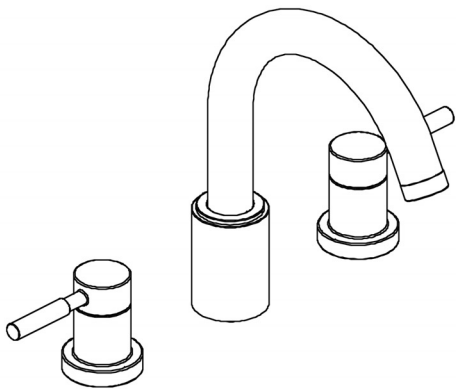

Need Help?

For additional assistance or service call:

SPEAKMAN Company
400 Anchor Mill Road
New Castle, DE 19720

PHONE: 800-537-2107
EMAIL: customerservice@speakmancompany.com
WEB: www.speakmancompany.com

92-3336-R1

What You Need To Know:

Tools:

Required:

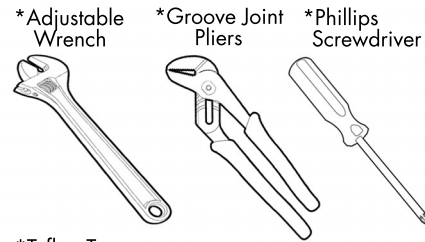

*Teflon Tape



Helpful:

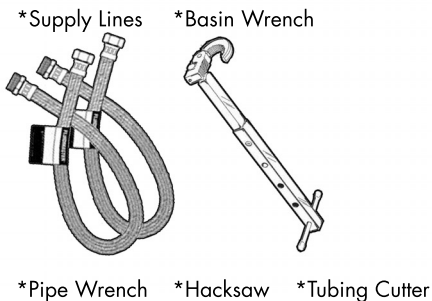

*Utility Knife *Eye Protection

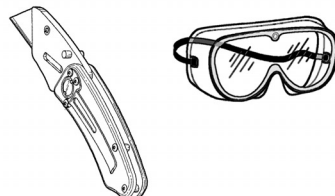

What You Need To Know:

Important Notes:

Be sure to read instructions thoroughly before beginning installation. Do not overtighten any connections or damage may occur. This faucet has an operating range of 20-80 psi.

Safety Tips:

Cover your drain to prevent loss of parts.

Be sure to wear eye protection while cutting pipe.

Maintenance:

Your new Roman Tub Faucet is designed for years of trouble-free performance. Keep it looking new by cleaning it periodically with a soft cloth. Avoid abrasive cleaners, steel wool, and harsh chemicals as these will dull the finish and void your warranty.

1 Drill holes in finished deck per diagram.

Note:

This system is intended for installations up to 2" thick.

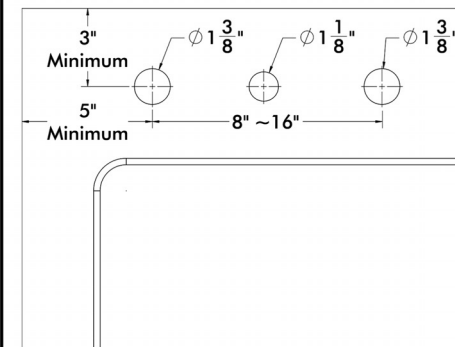

2 From underneath the deck, insert valve body with rubber washer (1), metal washer (2), and mounting nut (3), through holes on the right (COLD) side. From above, thread flange (4) onto valve stem. Tighten mounting nut (3), so that the flange (4) sits flush to the surface of working area. Repeat for left (HOT) side. Note: HOT side end valve is labeled.

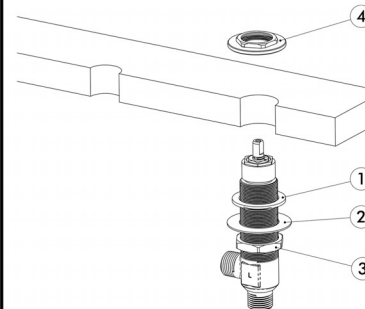

2x

3 Thread Handle Assembly (1) onto Flange (2)

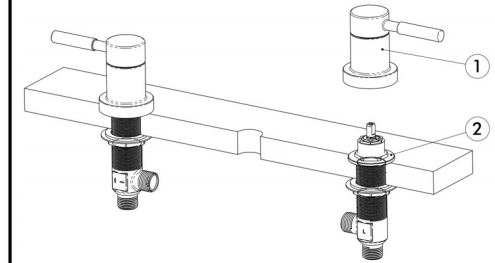

2x

4 Place spout assembly (1) thru mounting hole in deck. Secure spout with rubber washer (2), metal washer (3), and nut (4). Tighten nut (4) securely with wrench.

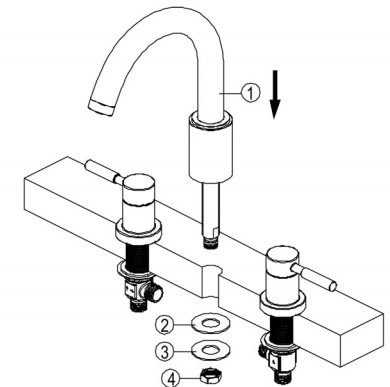

5 Insert T-tube (1) onto spout shank (2) until it is completely seated. Place clip (3) thru slots (4).

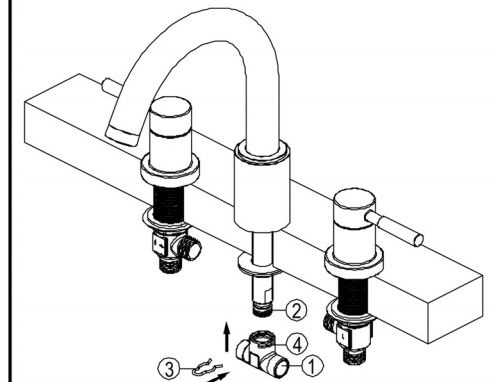

- 6** Connect water supply lines ① to faucet inlets ②
 NOTE: Supply lines are not included.

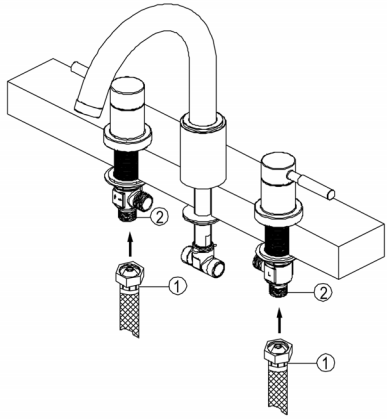

- 7** Connect the flexible water supply hose ① (included) to the bottom of valve bodies ② as shown. Align T-tube ③ to a position which will allow maximum clearance to connect hoses. Carefully bend hoses to fit available space. Thread the hose couplings to the sides of the T-tube ③.

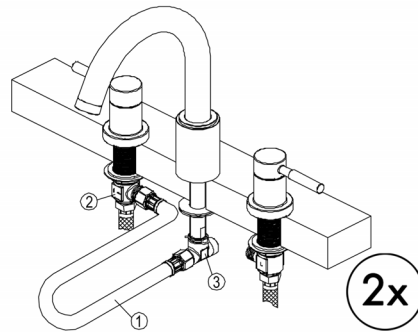

- 8** **IMPORTANT:** After installation is completed, turn on water supply and allow both hot and cold water to run for at least one minute each.

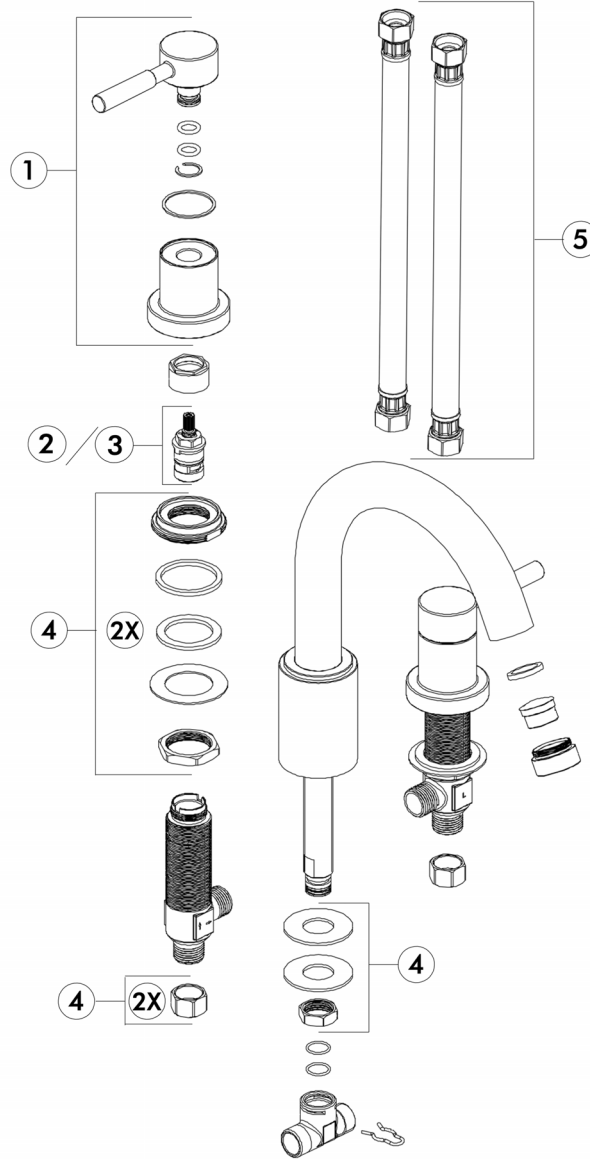
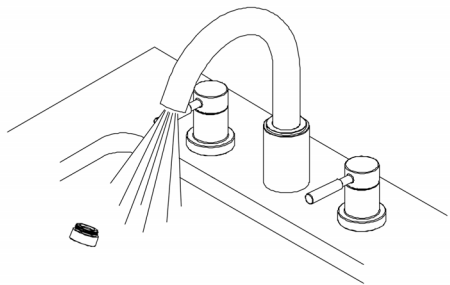

- ① RPG04-0397-(PC,BN,PN)
- ② RPG05-0889 (HOT VALVE)
- ③ RPG05-0890 (COLD VALVE)
- ④ RPG45-0047
- ⑤ RPG63-0085

