

## INSTRUCTIONS FOR MODELS

# VS-118

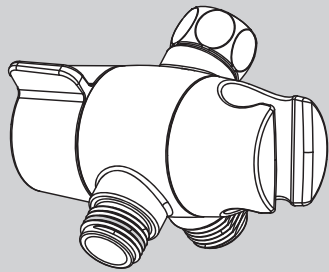

**NOTE:** VS-118 is designed to work with Speakman shower heads. It may or may not work with competitor shower heads.

### NEED HELP?

For additional assistance or service please contact:

**SPEAKMAN®**

800-537-2107

customerservice@speakman.com

www.speakman.com

92-VS-118-02

## TOOLS AND SUPPLIES

Adjustable  
Wrench



Thread Seal  
Tape



### IMPORTANT



- Do not over-tighten any connections or damage may occur.
- Be sure to read instructions thoroughly before beginning installation.

### SAFETY TIPS

Cover your drain to prevent loss of parts.

### MAINTENANCE

Your new Speakman Product is designed for years of trouble-free performance. Keep it looking new by cleaning it periodically with a soft cloth. The use of harsh chemicals and abrasives on any of the Speakman custom finish products may damage the finish and void the product warranty. Please be sure to only use approved cleaners. Please contact Speakman for any clarification of acceptable cleaners.

### WARRANTY

Warranty information can be found at:  
[www.speakman.com](http://www.speakman.com)

- 1 Thread Coupling Nut of Diverter onto Shower Arm. Tighten with Adjustable Wrench. **DO NOT** use Thread Seal Tape at this threaded connection.

**NOTE:** Inspect Diverter to be sure Sealing Washer is in place within Coupling Nut.

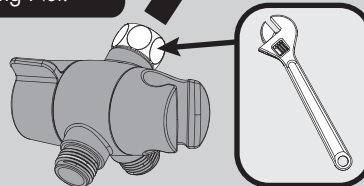

- 2 Verify that a sealing washer is present within the Fixed Shower Head to avoid leaks. If head does not have washer, use the included Thread Seal Tape and apply in clockwise direction to threaded connection. Thread Fixed Shower Head onto front outlet of Diverter. Tighten with adjustable wrench.

**NOTE:** Shower head not supplied with VS-118.

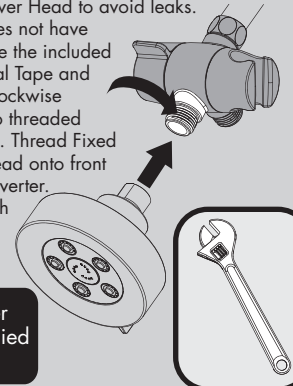

- 3 Thread Hose end with back flow protection device onto bottom outlet of Diverter. Ensure sealing washer is inside hose end to avoid leaks. Hand tighten connection.

**NOTE:** Hose not supplied with VS-118.

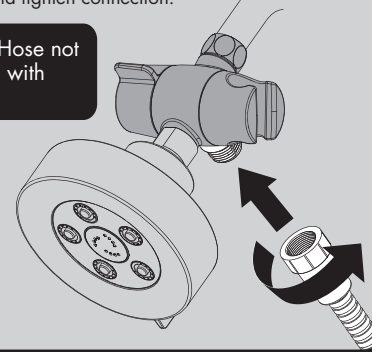

- 4 Thread other end of Hose onto base of Handheld Shower. Ensure sealing washer is inside Hose end to avoid leaks. Hand Tighten connection.

**NOTE:** Hand Shower not supplied with VS-118.

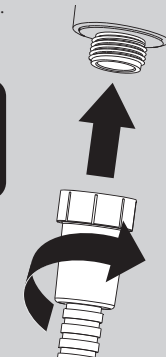

- 5 Place Hand Shower into Diverter Assembly.

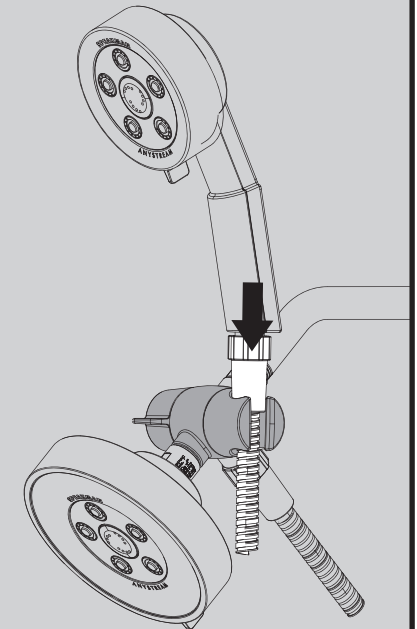

- 6 Turn on water supply and check all threaded connections for leaks. If leaks occur, tighten connection with an Adjustable Wrench or by hand. Check Diverter for proper operation by turning the side handle backward and forward to activate the Fixed or Hand Showers.

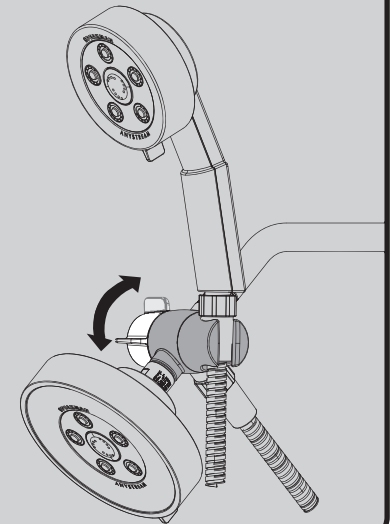

**NOTES:**

**COMPLIANCE:**

ASME A112.18.1/CSA B 125.1

**CONNECTIONS:**

- Inlet: 1/2" NPSF
- Outlets: 1/2" NPSM

Contractor to supply necessary inlet connections.

