

Instructions for Models:

S-3762
S-3762-HS
S-3762-E
S-3762-E-HS

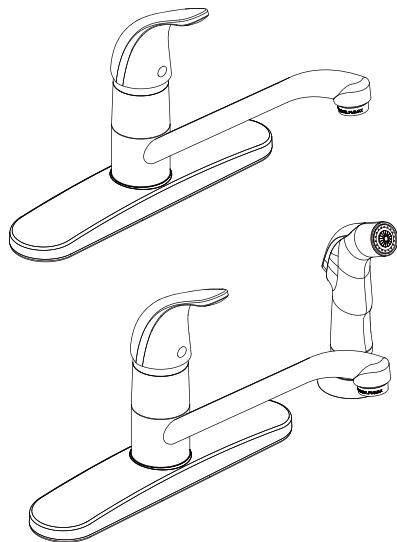

Need Help?

For additional assistance or service call:

SPEAKMAN Company
400 Anchor Mill Road
New Castle, DE 19720

PHONE: 800-537-2107
EMAIL: customerservice@speakman.com
WEB: www.speakman.com

92-S-3762-R3

What You Need To Know:

Tools:

Required:

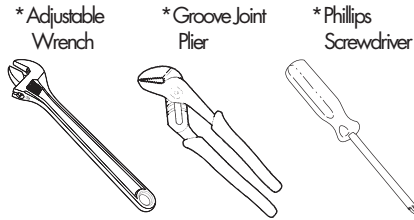

*Teflon Tape



Helpful:

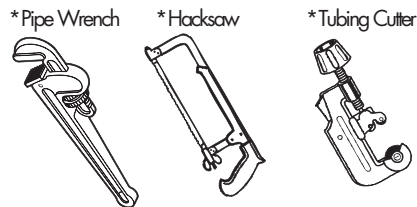
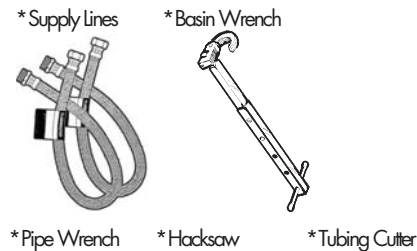

*Utility Knife *Eye Protection

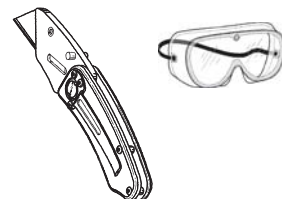

What You Need To Know:

Important Notes:

Be sure to read instructions thoroughly before beginning installation. Do not overtighten any connections or damage may occur. This faucet has an operating range of 20-80 psi.

Safety Tips:

Cover your drain to prevent loss of parts.
Be sure to wear eye protection while cutting pipe.

Maintenance:

Your new Kitchen Faucet is designed for years of trouble-free performance. Keep it looking new by cleaning it periodically with a soft cloth. Avoid abrasive cleaners, steel wool and harsh chemicals as these will dull the finish and void your warranty.

- ③ Insert the side sprayer (1) hose down through the sprayer support (2) and sink. Align the tabs (3 & 4) on the quick connects (5). Push the quick connector housing firmly upward and snap it onto the receiving tube tab. Pull down moderately to ensure the connection has been made. If it is necessary to remove the quick connector, squeeze the tabs on the hose, and pull down to disconnect.

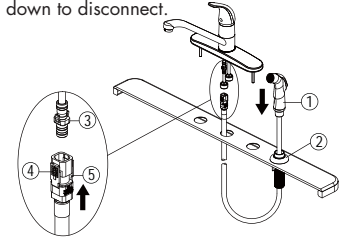

- ① Shut off water supply. Remove old faucet. Clean sink surface in preparation for new faucet. Place the gasket (1) on the bottom of the new faucet assembly (2).
If your model has a side sprayer, proceed to step 2. If your model does not have a side sprayer, skip to step 4.

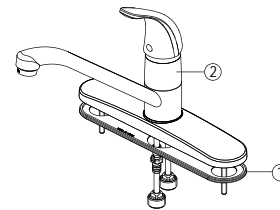

- ④ Place the faucet assembly (1) in position on the sink. Secure the faucet assembly (1) to the sink using the mounting nuts (2) provided. Hand tighten only.
NOTE: If the sink is uneven, use silicone under the gasket (3).

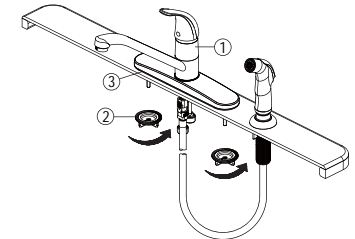

- ② Insert the sprayer support (1) through the far right hole on the sink. Screw the sprayer mounting nut (2) onto the sprayer support (1) shank from underneath the sink, and hand tighten.

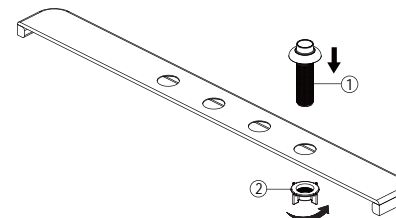

- ⑤ Make connections to water lines. Use 1/2" IPS faucet connections (1) or use the supplied coupling nuts (3) with 3/8" O.D. ball-nose risers (2). Use wrenches to tighten connections. Do not overtighten.

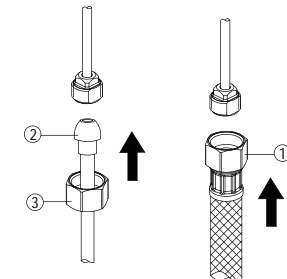

6

IMPORTANT:

After installation is completed, remove aerator. Turn on water supply and allow both hot and cold water to run for at least one minute each. While water is running, check for leaks. Replace aerator. Do not lose the gasket (1) in the aerator.

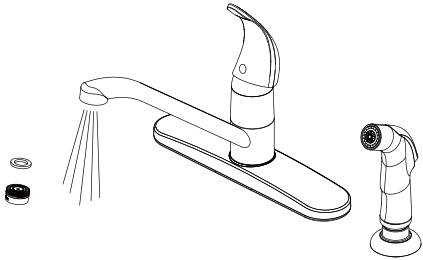

- ① RPG41-0107
- ② RPG05-0822
- ③ RPG49-0004
- ④ RPG05-0797 (1.5GPM)
- ⑤ RPG01-0054
- ⑥ RPG05-0852
- ⑦ RPG05-40049 (1.8GPM)

