

INSTRUCTIONS FOR MODELS

S-2570

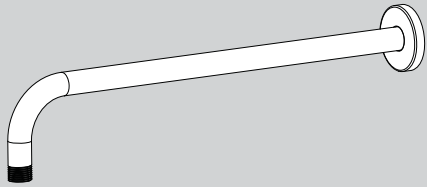

NEED HELP?

For additional assistance or service please contact:

SPEAKMAN® Company
400 Anchor Mill Road
New Castle, DE 19720

800-537-2107

customerservice@speakman.com

www.speakman.com

92-S-2570-01

TOOLS AND SUPPLIES

Thread Seal
Tape



Hex Key Wrench
(INCLUDED)

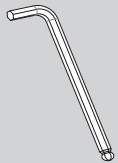

1 Slide the Escutcheon Plate **1** over the long arm of the Shower Arm **2** as shown below.

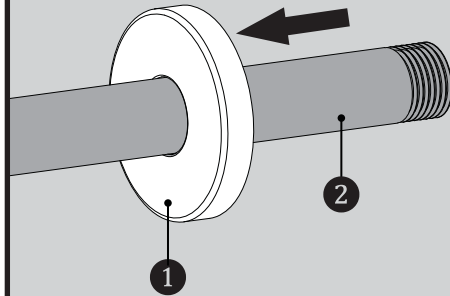

2 Apply Thread Seal Tape to inlet side of Shower Arm **2**. Thread Shower Arm into Female Pipe Fitting within the wall. Firmly tighten, and make sure Shower Arm Outlet is pointing in a downward position.

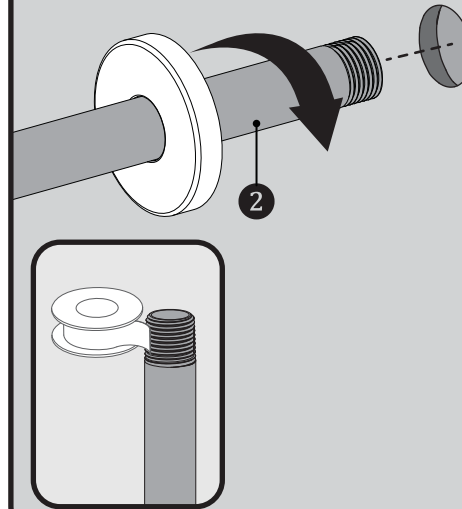

3 Position Escutcheon Plate **1** flat against wall. Secure Set Screw with Included Hex Key Wrench.

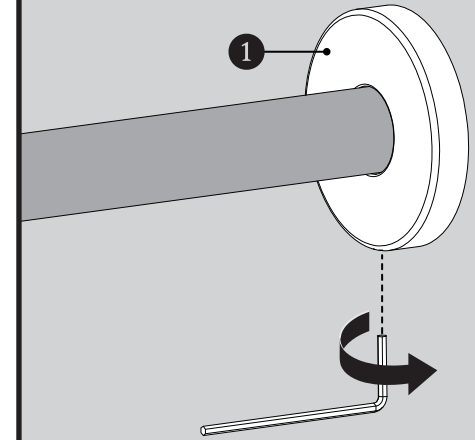

IMPORTANT

Be sure to read instructions thoroughly before beginning installation. Do not overtighten any connections or damage may occur.

SAFETY TIPS

Cover your drain to prevent loss of parts.

MAINTENANCE

Your new Shower Arm is designed for years of trouble-free performance. Keep it looking new by cleaning it periodically with a soft cloth. Avoid abrasive cleaners, steel wool and harsh chemicals as these will dull the finish and void your warranty.

WARRANTY

Additional warranty information can be found at: www.speakman.com

S-2570 ROUGH IN DIAGRAM

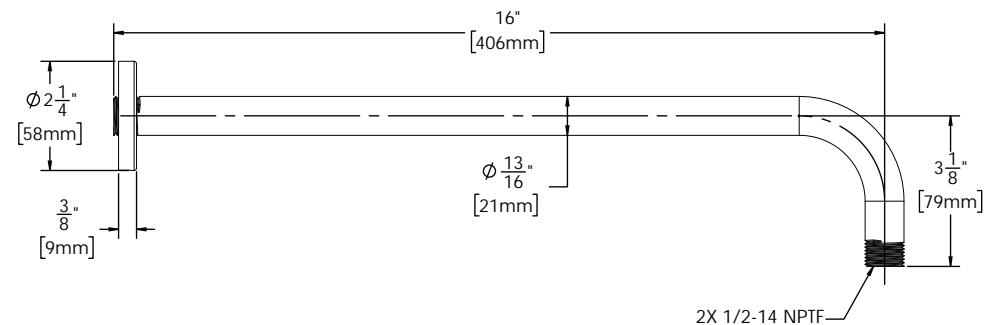

Specifications:

Supply Inlet: 1/2" NPT MALE

Outlet: 1/2" NPT MALE

Note: Dimensions are subject to change without notice

The supply fittings behind the wall shall be properly secured and anchored to support the shower arm and any attachments added.