

OTR24XU



Product family	Microwave oven
Category	Built-in
Installation type	Built-in
Power source	AC
Cooking Method	Microwave
Oven controls	Electronic



Aesthetic

Color	Stainless steel/Black	Silkscreen color	White
Material	Stainless steel and glass	Logo	Silkscreened

Program / Functions



Number of functions	4	Microwave	Yes
Defrost by time	Yes	Microwave special functions	Sensor cook
Defrost by weight	Yes		

Controls



Display	1 LED	Opening	Side opening
Controls	Touch controls		

Options



Timer	Electronic	Turntable stop option	Yes
End-of-cooking acoustic alarm	Yes	Quick-start option	Yes
Child safety lock	Yes		

Technical Features



Cavity material	Galvanized steel	Total no. of door glasses	1
No. of lights	1	Security Thermostat	Yes
Lighting	LED	Microwave door protection screen	Yes
Turntable	Yes	Microwave stops when door is opened	Yes
Turntable dimensions	13 9/16 "	Inner cavity dimensions (HxWxD)	272x388x391 mm
Light on when door is open	Yes	Microwave effective power	1000 W

Accessories Included

Glass tray	Glass tray
------------	------------

Performance / Energy Label





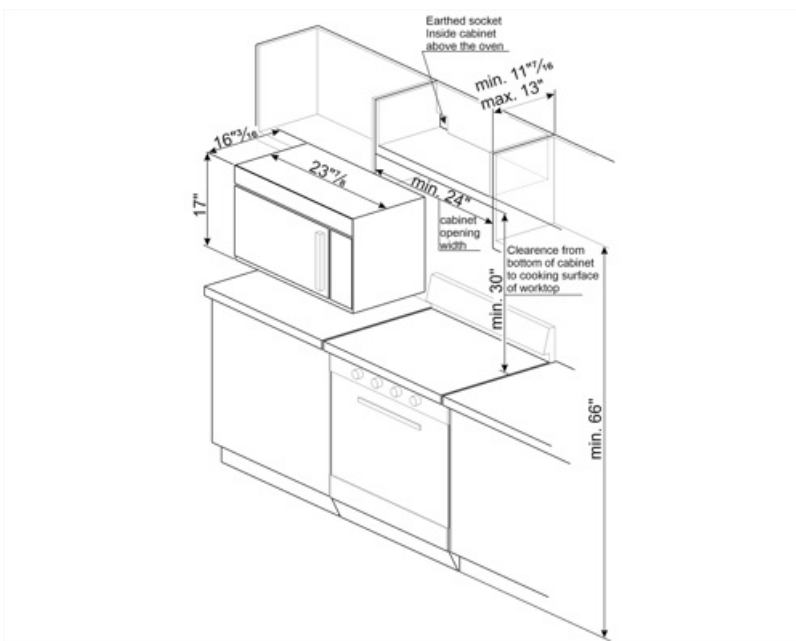

Volume	38 cu. ft.
--------	------------

Electrical Connection

Current	15 A	Frequency	60 Hz
Voltage	120 V	Power cord length	39 3/8 "



Symbols glossary

- | | | | |
|--|--|---|---|
|  | Child lock: some models are fitted with a device to lock the programme/cycle so it cannot be accidentally changed. |  | Microwave energy shortens cooking times dramatically and produces energy savings. |
|  | Defrost by time: with this function the time of thawing of foods are determined automatically. |  | Defrost by weight: With this function the defrosting time is determined |
|  | Microwave: Penetrating straight into the food, microwaves cook very quickly and with considerable energy savings. Suitable for cooking without fat, they are also able to thaw and heat food without altering its original appearance and aroma. The microwave function can also be combined with conventional functions with all the resulting advantages. Ideal for all types of food. |  | Side lights: Two opposing side lights increase visibility inside the oven. |
|  | Touch controls: Easy to use touch controls allow the appliance to be programmed at the touch of a button. | | |