

# FZU30L



Product family	Freezers
Installation	Built-in
Category	One Door
Cooling type	No-frost
Hinge	Door-to-door
Hinge position	Left



## Aesthetic

Aesthetics	Universal	Logo	Silkscreened
Material	Stainless steel	Drawers profile color	Silver
Side material	Metal	Display	TFT
Side color	Steel		

## Freezer features



Freezer lighting	Yes
Freezer lighting	LED
Number of drawers	4

## Other Freezer features

Ice maker	Automatico
-----------	------------

## Other technical features



Display functions	Holiday, Fast-freezing, MultiZone, Sabbath	No. of compressors	1
Fast-freezing button	Yes	Refrigerant gas type	R600a
Power-on light	Yes	Type of compressor	Inverter
Door-open alarm	Yes	Refrigerant quantity	85 oz
Antibacterial Gasket	Yes	Foam agent	Other

Type of temperature control      Electronic

## Performance / Energy Label

Total volume                      15.96 cu. ft.

## Electrical Connection

Nominal power rating      344 W  
 Current                      2.5 A  
 Voltage                      115 V



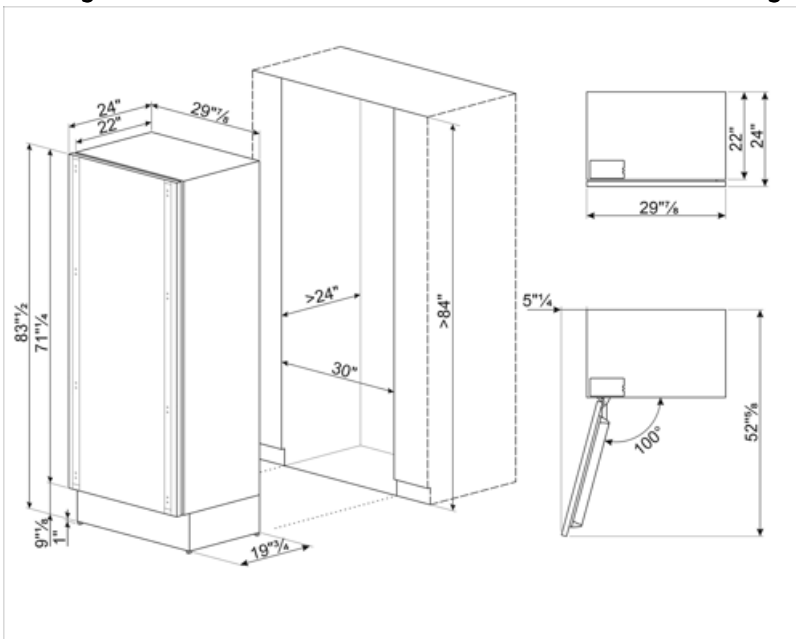



Frequency (Hz)              50 Hz  
 Power cord length          78 3/4 "  
 Plug                              (B) NEMA 5-15P



---

## Symbols glossary

---

- |   |  |
|---|--|
|  <p>Fast freezing: The fast freezing function brings the temperature of the compartment down when activated a few hours prior to usage.</p>   |  <p>Power saving mode: The power saving mode allows you to disable the refrigerator and keep the freezer working.</p>   |
|  <p>LED interior lighting: is a more energy efficient and long lasting way of illuminating the interior of the appliance.</p>   |  <p>Inverter technology: The evolution of Smeg's driers towards more intelligent and environmentally sustainable models has led to the choice of using Inverter technology with heat pumps, which reduces significantly energy consumption.</p> |
|  <p>Multizone: Multizone compartment can be used as a refrigerator or a freezer compartment. Depending on your needs and eating habits, you can select settings, program the temperature using.</p> |  <p>No Frost: The No Frost and Frost free systems prevent ice from forming so that no defrosting is required.</p>   |