

FD30UXI



Product family	Refrigerator
Installation	Freestanding
Category	French-door
No-frost system	Yes
Cooling type	Total no-frost - Dual-flow cooling system
Defrost	Automatic
Hinge	Standard
Counter-depth	Yes
EAN code	8017709344023



Aesthetic



Aesthetics	SPR	Side material	Steel
Color	Stainless steel	Side color	Steel
Material	Steel	Logo	Applied
Door stainless steel type	Normal	Door shelf profile color	Silver
Handle	External	Drawers profile color	Silver
Handle	Fixed	Glass shelf profile color	Silver
Handle color	Stainless steel	Display	LED
Logo color	Stainless steel	Display position	Internal

Refrigerator compartment features



Number of compartments	3	Type of crisper cover	Glass
Compartment types	Low temperature compartment, Fruit and vegetable compartment	No. of lights	1
Type of adjustable shelves	Glass	Low temperature compartment	Yes
Crisper drawer type	Standard	Refrigerator lighting	Yes
Crisper cover	Yes	Refrigerator lighting	LED

Refrigerator Inner Door

Number of adjustable door shelves	4	No. of bottle shelves	2
--	----------	------------------------------	----------

Other Refrigerator features



Humidity Control	Yes	Fan	Yes
MultiFlow	Yes		

Freezer features

Number of drawers	2	Freezer lighting	Yes
No. of lights	2	Freezer lighting	LED

Other Freezer features

Accessories	1 x ice box	Ice maker	Automatic
--------------------	--------------------	------------------	------------------

Other technical features

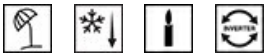

Display functions	Holiday, Fast-freezing, Sabbath
Fast-freezing button	Yes
Water network connection	Yes
Power-on light	Yes
Temperature alarm	Yes
Door open alarm	Yes
Temperature setting type	Electronic
No. of compressors	1
Refrigerant gas type	R600a
Compressor type	Inverter
No. of evaporators	2
Foam agent	Cyclopentane

Performance / Energy Label

Total volume	16.10 cu. ft.	Noise level	39 dB(A) re 1 pW
Freezer volume	5.19 cu. ft.	Freezer capacity	5.76 cu. ft.
Refrigerator compartment	10.81 cu. ft.	Refrigerator volume	11.72 cu. ft.

Electrical Connection

Electrical connection rating	200 W	Frequency (Hz)	60 Hz
-------------------------------------	--------------	-----------------------	--------------







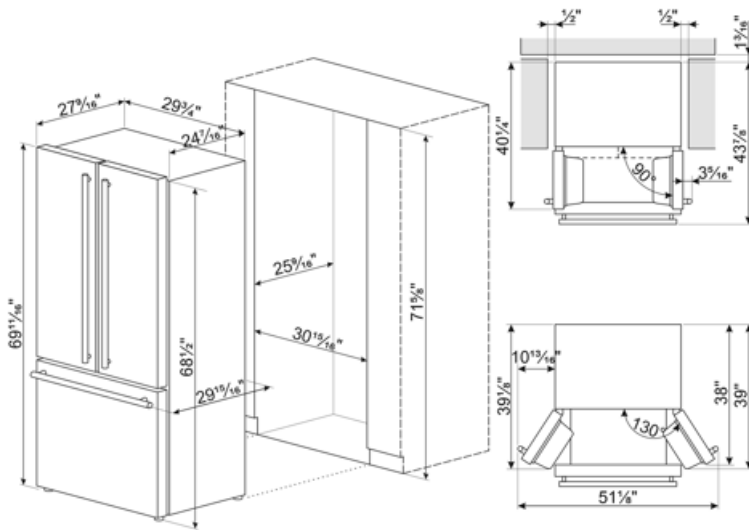

Current	2 A	Power cord length	84 5/8 "
Voltage (V)	120 V	Plug	(B) NEMA 5-15P

Logistic Information

Width	29 15/16 "	Width with doors open at 90°	50 7/8 "
Depth without handle	27 9/16 "	Product depth (handle included)	29 15/16 "
Height	69 11/16 "	Depth with door open at 90°	40 1/4 "



Symbols glossary

- | | | | |
|--|---|---|---|
|  | The automatic defrost system works by automatically defrosting at regular intervals eliminating the need to defrost altogether. |  | LED display: to show programmes, functions and options selected and the time to the end of the cycle. |
|  | Ventilated: Forced distribution of cold air in the refrigerator compartment, which allows even temperature distribution within the fridge. |  | Fast freezing: The fast freezing function brings the temperature of the compartment down when activated a few hours prior to usage. |
|  | Power saving mode: The power saving mode allows you to disable the refrigerator and keep the freezer working. |  | LED interior lighting: is a more energy efficient and long lasting way of illuminating the interior of the appliance. |
|  | Inverter technology: The evolution of Smeg's driers towards more intelligent and environmentally sustainable models has led to the choice of using Inverter technology with heat pumps, which reduces significantly energy consumption. |  | Air plus: keeps food fresher for longer. |
|  | Sabbath: This function allows you to cook food during the Sabbath, the Holiday of rest in the Jewish religion, respecting the precepts. | | |