

96" HAL BARN DOOR HARDWARE KIT

SKU: 950669

Code: HBD5000X96, HBD5911

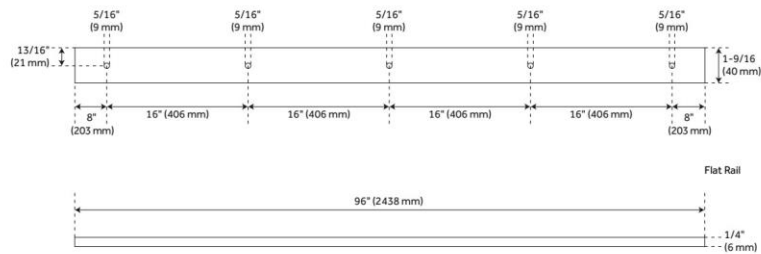

FEATURES

Material: Steel

ADDITIONAL FEATURES

- Brushed nickel, oil rubbed bronze, black, and champagne brass finishes are made of steel.
- Stainless steel finish is made of stainless steel.
- For doors up to 48" wide.
- Wheel: 2-3/4" diameter.
- Steel 1-1/4" diameter roller bearings.
- Track Size: 1/4" steel, 1-1/2" x 96".
- Strap Size: 1/4" Steel, 11-1/2" x 1-1/2".
- Optional Soft Close Adapter:
 - Door weight needs to be 66-132 lbs and not exceeding 176 lbs for the soft-close function to work properly.
 - For use with flat rails.

REVISED 9/4/2024

96" HAL BARN DOOR HARDWARE KIT

SKU: 950669

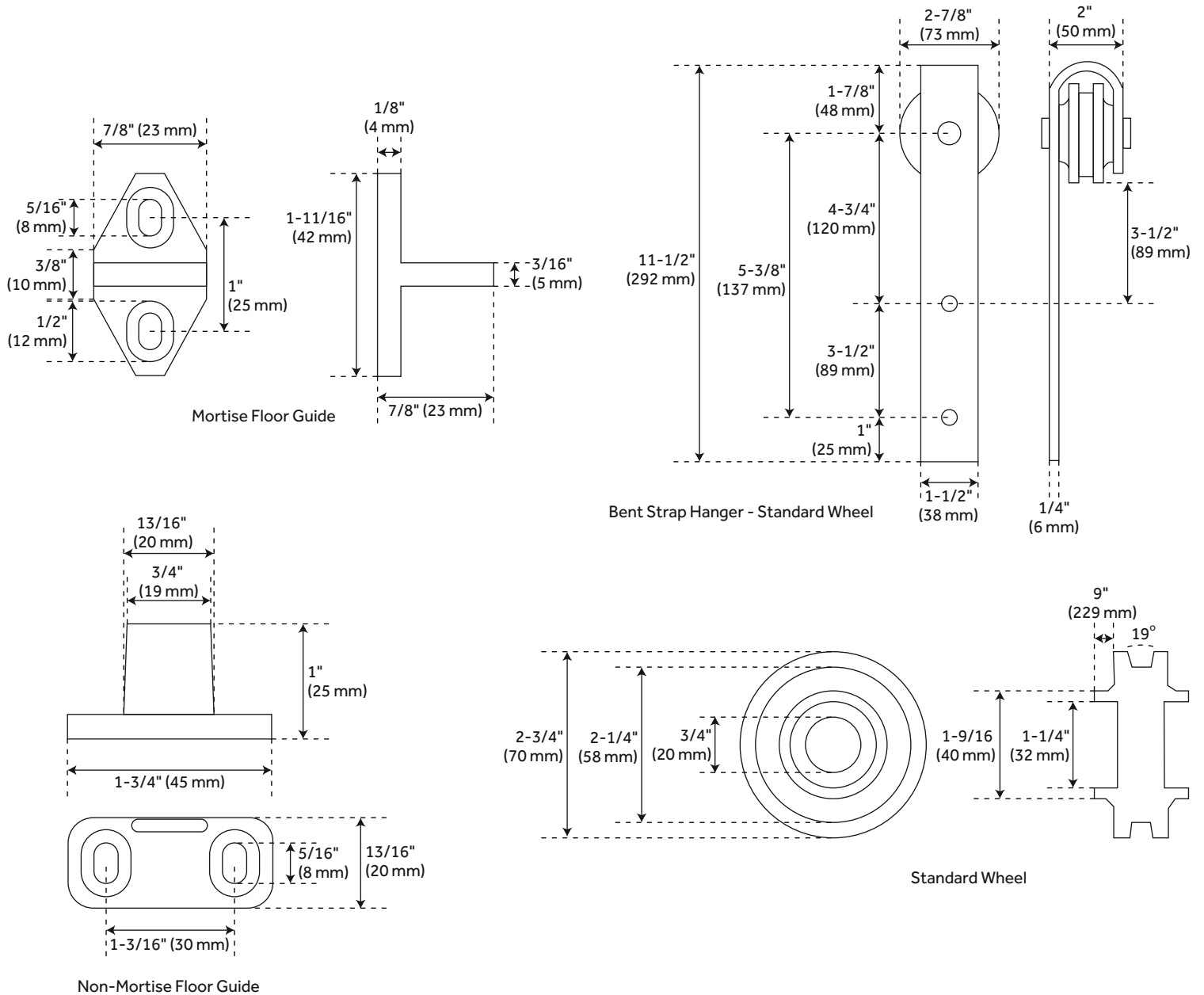

All dimensions and specifications are nominal and may vary. Use actual products for accuracy in critical situations.

96" HAL BARN DOOR HARDWARE KIT

SKU: 950669

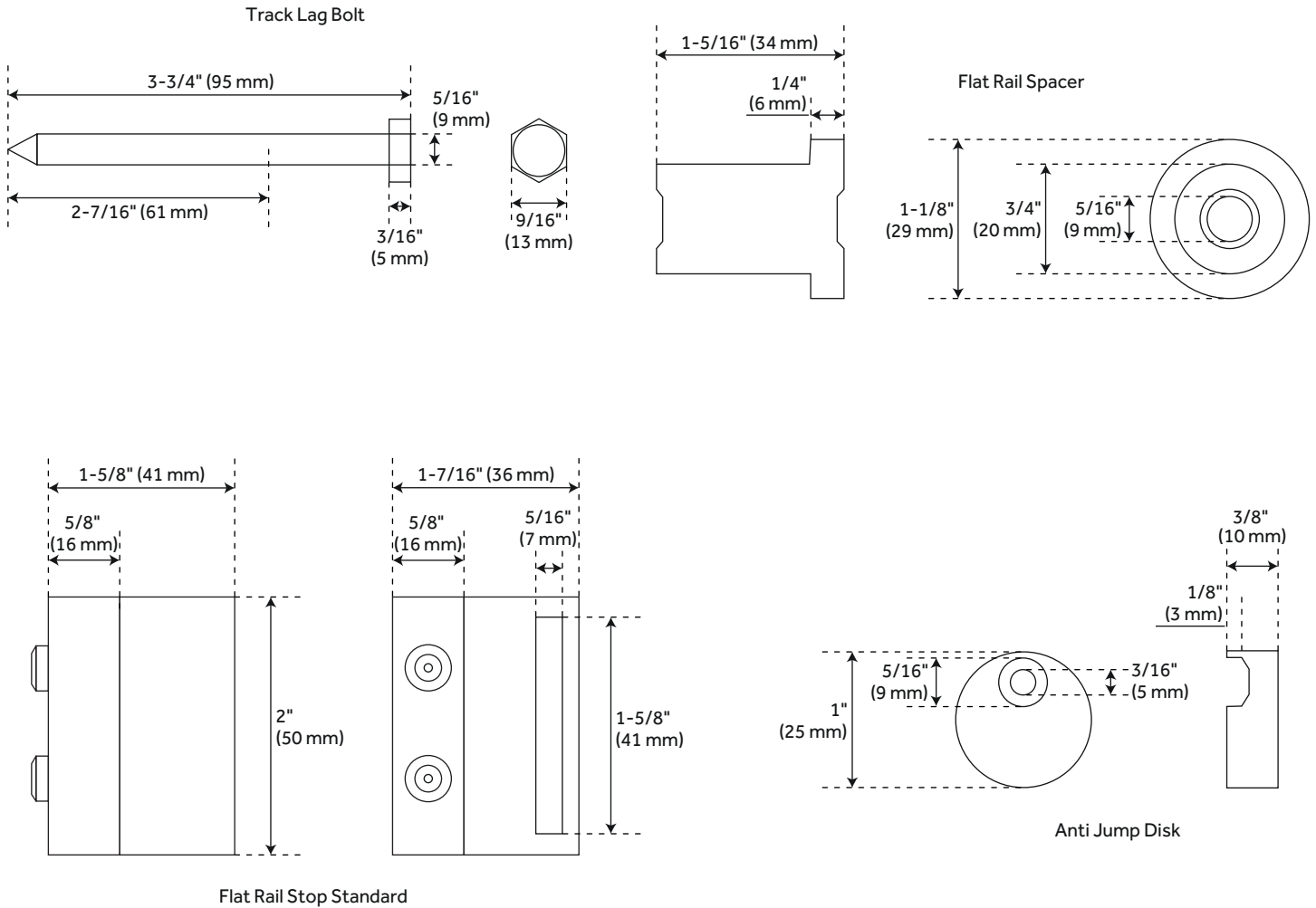

All dimensions and specifications are nominal and may vary. Use actual products for accuracy in critical situations.