

71" SHEBA ACRYLIC SLIPPER TUB WITH FOAM - AIR MASSAGE

SKU: 462912
Code: SH462912



FEATURES

Tub Material: Acrylic
Product Finish: White
Shape: Oval
Tub Drain Placement: End
Drain Included: Yes
Drain and Overflow Finish: White
Water Depth to Overflow: 15-3/8"
Water Capacity (Gallons): 73
Built-In Adjusters: Yes
Tub Weight Uncrated (lbs): 154

ASME A112.19.7/CSA B45.10, Massachusetts Accepted, LISTED ID: SHSBFOSS7132FAWH



ADDITIONAL FEATURES

- All dimensions are ($\pm 1/2$ ").
- Features 12 air jets that massage and relax. Remote control works within 15-foot radius and is designed to float.
- Foam Insulation increases heat retention and prevents condensation due to water and air temperature fluctuations.

REVISED 8/2/2024

71" SHEBA ACRYLIC SLIPPER TUB WITH FOAM - AIR MASSAGE

SKU: 462912
Code: SH462912

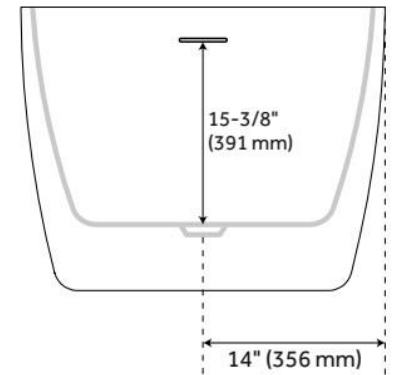
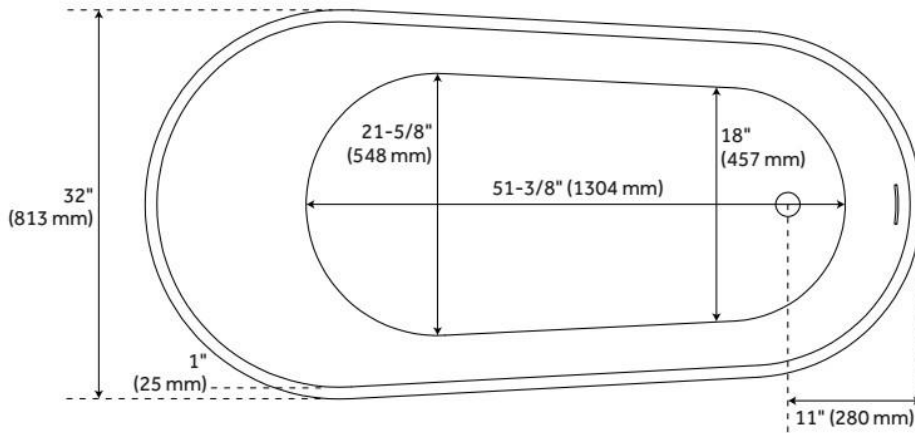
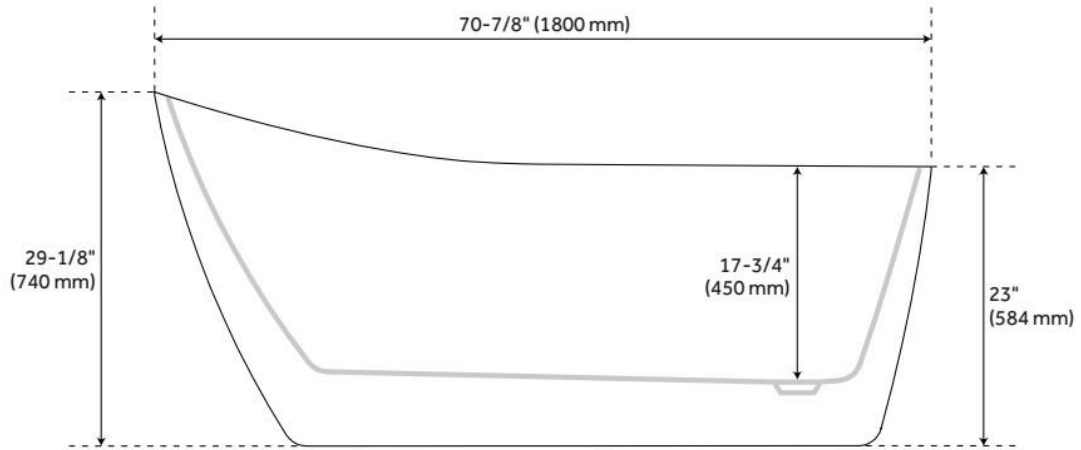

REVISED 8/2/2024

71" SHEBA ACRYLIC SLIPPER TUB WITH FOAM - AIR MASSAGE

SKU: 462912
Code: SH462912

COMPONENTS LIST

- BM-TWP BALL CHECK VALVE JETS
- MANI-SD-A SECURITY DEVICE
- MAN-A-4-AC MANIFOLD
- SILVER SLS+ VARIABLE SPEED BLOWER

INSTALLATION

Install blower behind a wall (with an access panel) or in a closet. Blower can also be installed under floor. Ensure the security device, MANI-DS-A, is at least:

- 2" Above the tub rim

Security device and hose can be mounted in wall

REMOTE CONTROL

- CG+/RTC-SENSOR-WP
- 12 – 15 YEAR BATTERY LIFE

INSIDE OF BATH

- (12) MAXI AIR JETS WITH 24 OPENINGS



ELBOWS FOR
AIR JETS



TEES FOR
AIR JETS

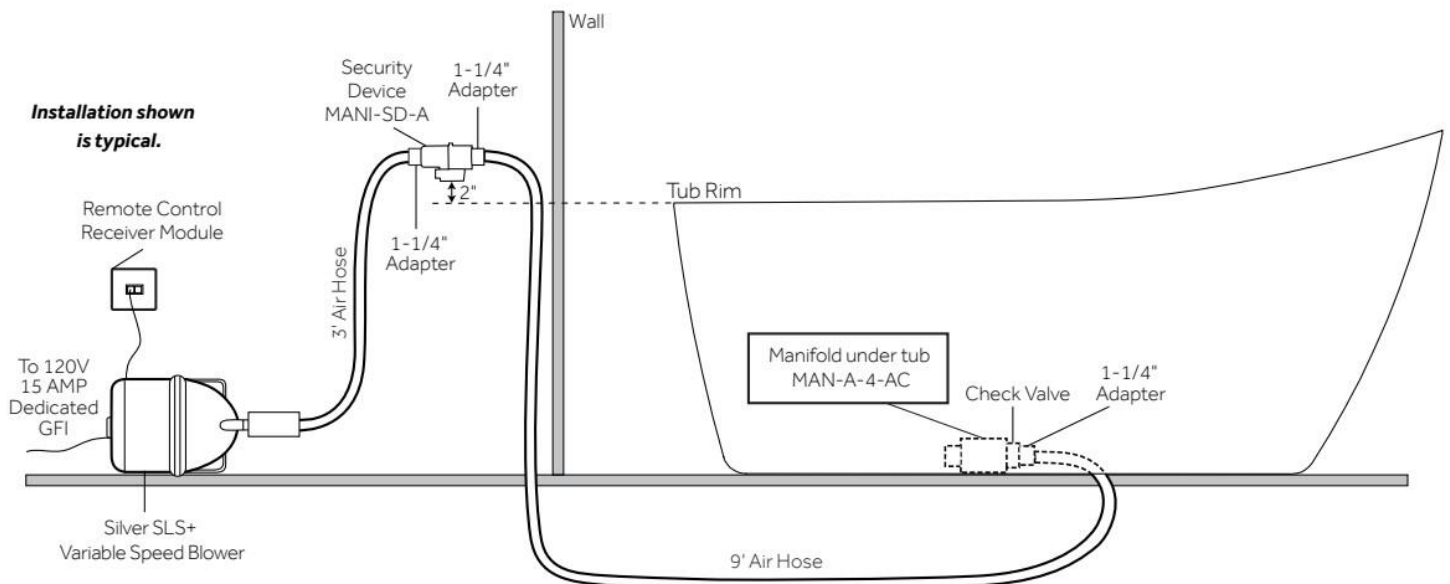
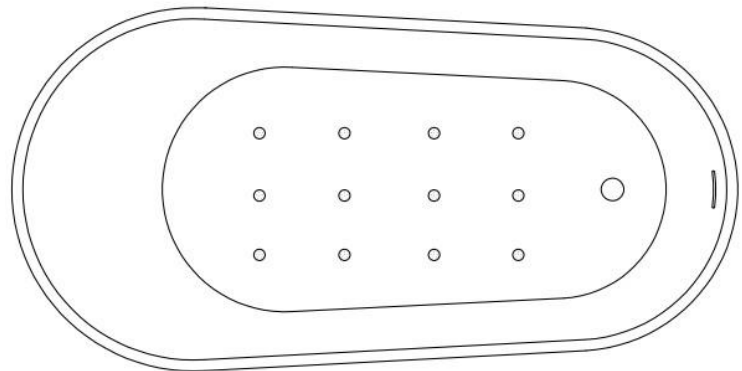

All dimensions and specifications are nominal and may vary. Use actual products for accuracy in critical situations.

REVISED 8/2/2024