



# CURVED DOUBLE SHOWER CURTAIN ROD

## BEFORE INSTALLING

Read entire shower rod installation Instructions. Observe all local building and safety codes. For the following installation instructions it is assumed that any old fixtures have been removed and any repairs to the wall have been completed.

## INSTRUCTIONS

Unpack and inspect the product for any shipping damages. If you find damages, do not install. Contact Customer Service at 1.855.715.1800. If you need assistance or have questions while installing your shower rod contact Customer Service.

We recommend consulting a professional if you are unfamiliar with installing bathroom fixtures. Signature Hardware accepts no liability for any damage to the walls or ceiling, or for personal injury during installation.

## TOOLS AND MATERIALS:



Drill



Level



Tape Measure



Screwdriver



Pencil



Hammer



Hacksaw



1/4" Drill Bit

## INSTALLATION

1. Lay the rod sections on the floor. For rods 84" and longer, assemble with the connector piece.



2. Verify that the rod sections are the proper length for your installation. If not, trim with a hacksaw.

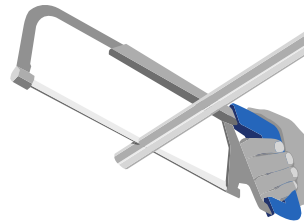

3. Have someone help you measure. Hold rod up to desired position, one person at each end to check the height and location. Making sure that rod is level, use a pencil to lightly score marks at the top and bottom of the wall plate. Set the rod down, then hold the wall brackets up at the desired mounting height.

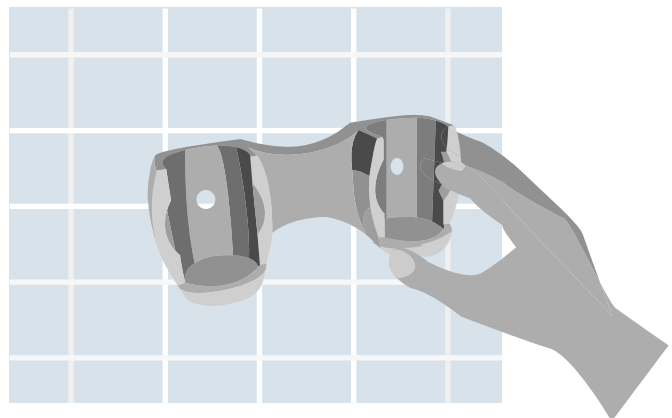



# CURVED DOUBLE SHOWER CURTAIN ROD

## INSTALLATION

4. Mark the placement of the mounting holes. Use a tape measure and level to make sure that your pencil marks are lined up properly on each wall.

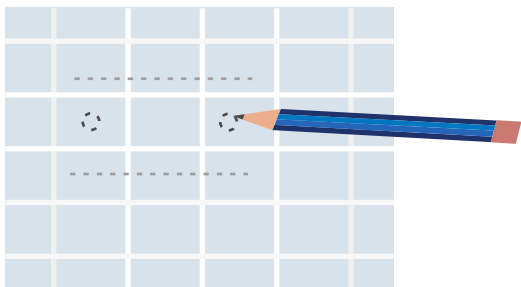

5. Drill pilot holes for the wall anchors.

**Note:** If there is a stud in your mounting location, use wood screws to attach the wall brackets.

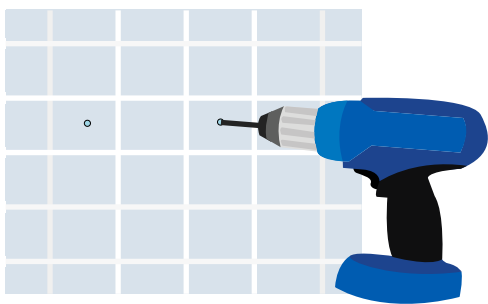

6. Gently tap the anchors into the pilot holes with a hammer.

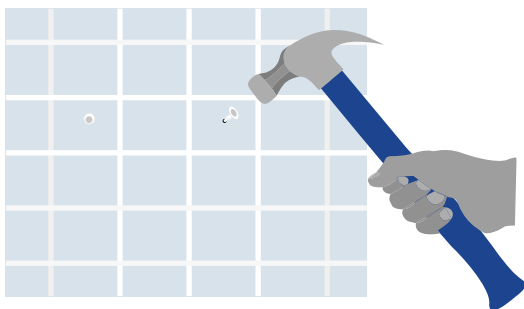

7. Insert the ends of the rod into the wall brackets. Tighten the set screws with a Philips head screwdriver to secure.

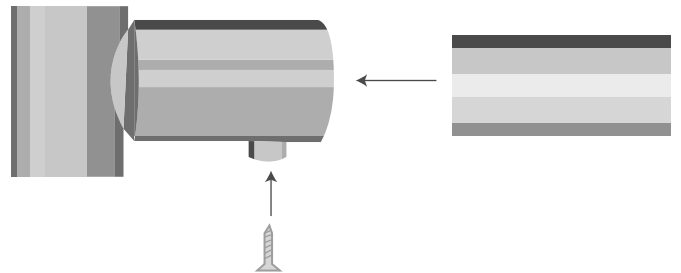

8. Attach the rod and brackets to the wall with the mounting hardware provided.

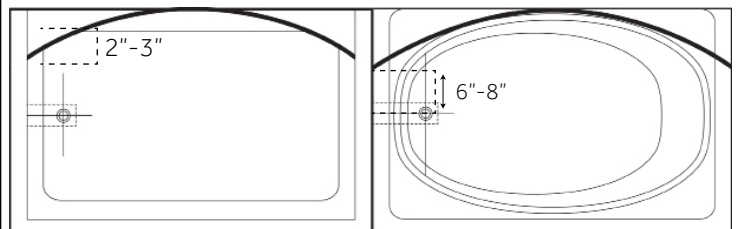
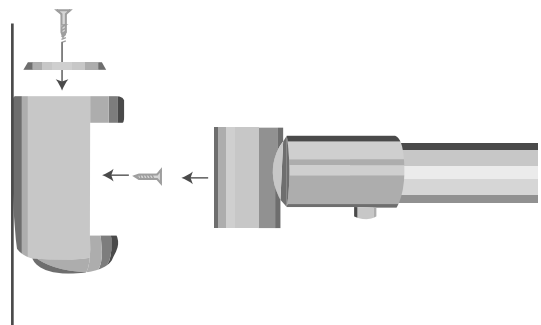

For 60" Standard Tub

Mount rod approximately 3" inside the point a straight rod is normally mounted. The midpoint of the rod should extend several inches past the outside rim of the tub.

For 60" Oval Tub

Depending upon tub model, mount rod between 6" and 8" from center line of the tub. The middle portion of the rod should curve just outside the contour of the tub.