

72" x 42" GALATIA

ACRYLIC DROP-IN TUB

SKU: 948261

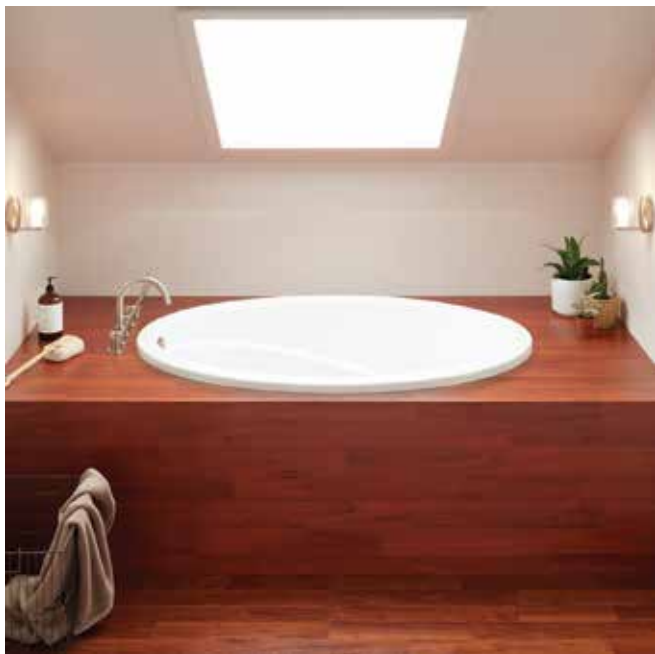

FEATURES

Product Finish: White
Overflow Hole: Yes
Shape: Oval
Material: Acrylic
Length: 72"
Width: 42"
Height: 21"
Tub Interior Length: 48-1/2"
Tub Interior Width: 27"
Tub Slope: 32.5°
Water Depth To Overflow: 17-1/2"
Drain Included: Optional
Drain Placement: End
Faucet Included: No
Water Capacity (Gallons): 99

SIGNATURE HARDWARE Lifetime Warranty

See website for detailed warranty information.

CONTENTS

AIR & WHIRLPOOL TUB	PAGE 2
72" X 42" TUB	PAGE 3

REVISED 10/10/2019

CODE: SHGAA7242WH/SHGAS7242WH/SHGAT7242WH/SHGAW7242WH

AIR TUB AND WHIRLPOOL TUB

COMPONENTS LIST

- Powerful whirlpool pump with variable flow device
- Heated blower for air bath system

INSTALLATION

- Whirlpool and Total Massage units require dedicated 20 Amp, 120V service
- You must provide a receptacle with a 20 Amp configuration
- Electrical outlet must be mounted 4" (101mm) above the floor line and 12" max (305mm) inside from the edge of the bathtub, or in accordance with local building and electrical codes

INTEGRATED CONTROL PANEL

- Intuitive electronic control buttons

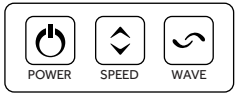
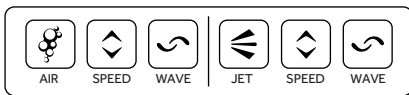

INSIDE OF BATH

- (8) HIGH-FLOW DIRECTIONAL AND VOLUME-ADJUSTABLE WHIRLPOOL JETS
- (65) CHANNEL-FED AIRJETS (air bath and total massage)



WHIRLPOOL JET

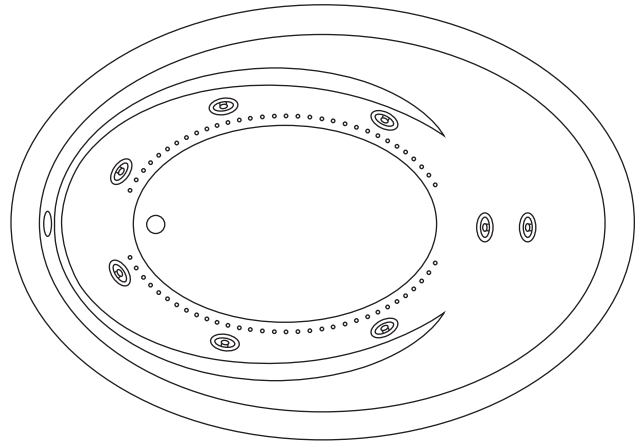

ELECTRICAL CONFIGURATIONS

WHIRLPOOL CIRCUIT WITH OPTIONAL HEATER

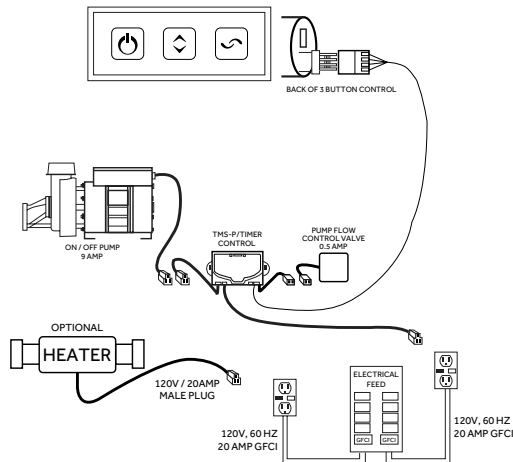

TOTAL MESSAGE CIRCUIT WITH OPTIONAL HEATER

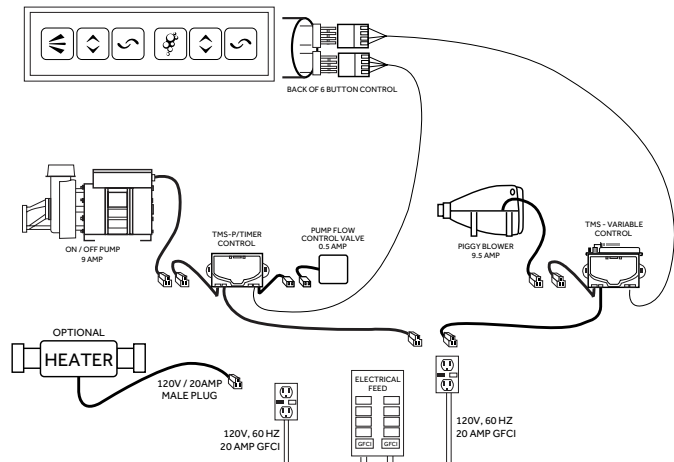

AIR MESSAGE CIRCUIT

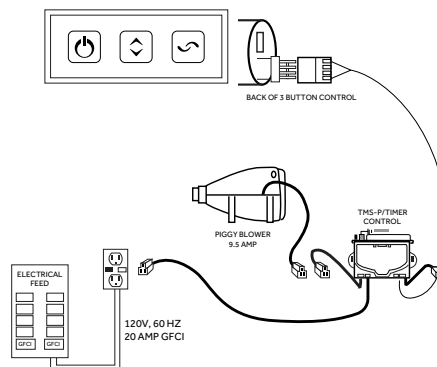

72" x 42" GALATIA

ACRYLIC DROP-IN TUB

SKU: 948261

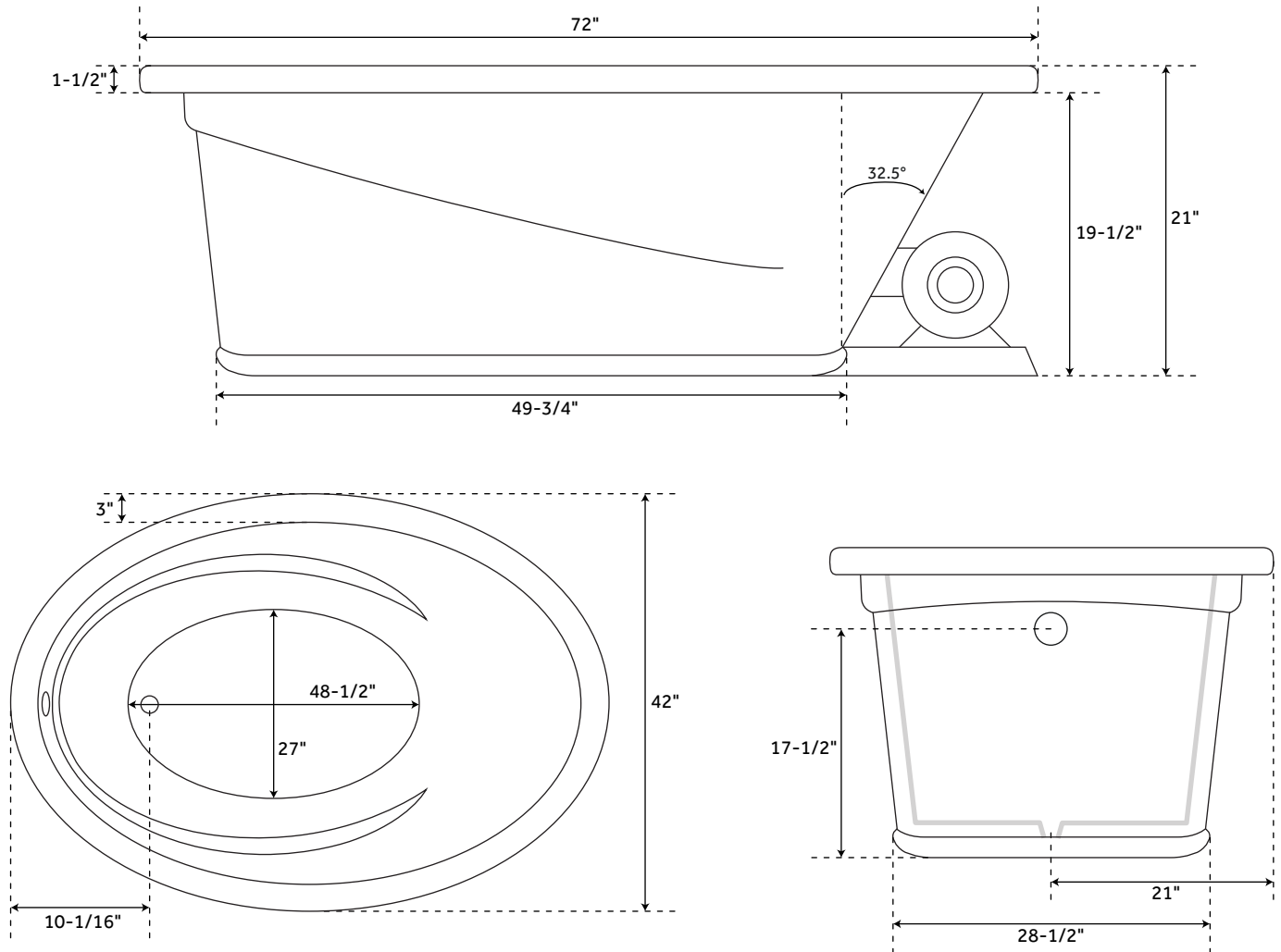

FEATURES

- Product Finish: White
- Overflow Hole: Yes
- Shape: Oval
- Material: Acrylic
- Length: 72"
- Width: 42"
- Height: 21"
- Tub Interior Length: 48-1/2"
- Tub Interior Width: 27"
- Tub Slope: 32.5°
- Water Depth To Overflow: 17-1/2"
- Drain Included: Optional
- Drain Placement: End
- Faucet Included: No
- Water Capacity (Gallons): 99

SIGNATURE HARDWARE LIFETIME WARRANTY

See website for warranty information



All dimensions and specifications are nominal and may vary. Use actual products for accuracy in critical situations.

PAGE 3