



# RECTANGULAR SHOWER CURTAIN ROD

## BEFORE INSTALLING

Read entire shower curtain rod installation instructions. Observe all local building and safety codes. For the following installation instructions it is assumed that any old fixtures have been removed and any repairs to the wall have been completed.

## INSTRUCTIONS

Unpack and inspect the product for any shipping damages. If you find damages, do not install. Contact Customer Service at 1.866.855.2284. If you need assistance or have questions while installing your curtain rod contact Customer Service.

We recommend consulting a professional if you are unfamiliar with installing bathroom fixtures. Signature Hardware accepts no liability for any damage to the walls or ceiling, or for personal injury during installation.

## TOOLS AND MATERIALS:



Drill



Level



Tape Measure



Screwdriver



Pencil



Hammer

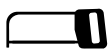

Hacksaw



1/4" Drill Bit

## INSTALLATION

1. Lay the rod sections on the floor. Insert the sections into the shower riser connector and shower rod connector. Tighten the set screws to hold the rectangular frame in place.

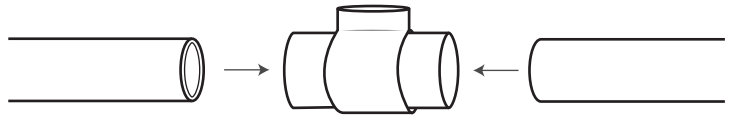

2. Thread the wall support into the shower riser connector, and the ceiling support into the shower rod connector.

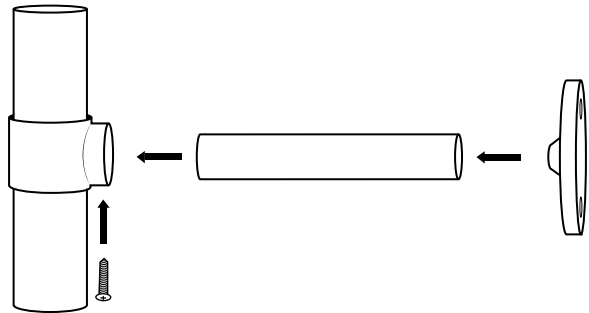

3. Hold the curtain rod in the desired mounting location. Measure the distance from the wall, and ceiling to the rod. If needed, trim the wall, and ceiling supports to the proper length with a hacksaw.

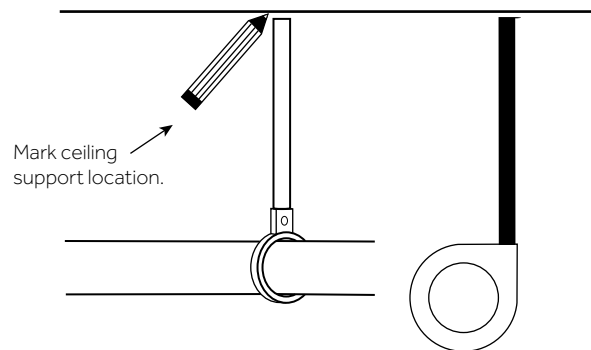



# RECTANGULAR SHOWER CURTAIN ROD

## INSTALLATION

4. Attach the mounting brackets to the wall and ceiling supports. Tighten the set screws to secure.

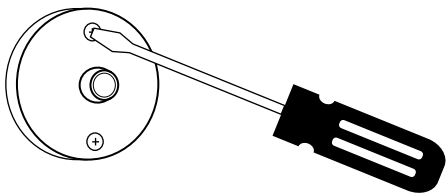

5. Hold the shower rod in place and mark the placement of the mounting holes.

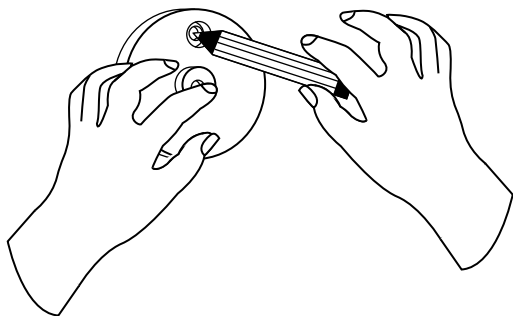

6. Drill pilot holes for the anchors.

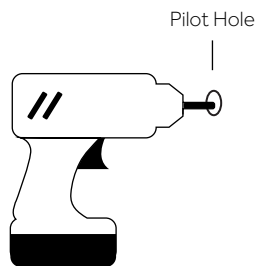

**X**

7. Gently tap the anchors into the pilot holes with a hammer.

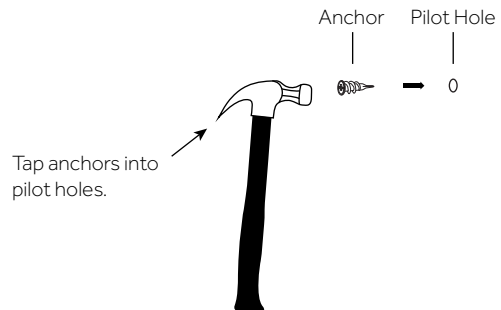

8. Attach the wall and ceiling bracket to the anchors with the mounting hardware provided.

