

COPPER FARMHOUSE SINK

WITH VINE DESIGN

SKU: 915858, 926763, 926765, 926764, 909167, 908073, 937090

BEFORE INSTALLING

Read the following installation below. Observe all local plumbing and building codes.

INSTRUCTIONS

Unpack and inspect the sink for any shipping damages and ensure that none of the required pieces are missing. If you find any damages, do not install. Contact Customer Service at 1-855-715-1800. If you need assistance while installing your new farmhouse sink, call our Customer Service number.

Due to the manufacturing process, each sink will vary slightly dimensionally. Farmhouse sinks may require custom cabinetry. We recommend consulting an experienced cabinet maker for assistance. Providing the cabinet maker with the actual sink to be installed will ensure a custom fit.

Please use assistance when lifting the sink in order to avoid personal injury.

We recommend consulting a professional if you are unfamiliar with installing kitchen fixtures and plumbing. Signature Hardware accepts no liability for any damages to the floor, walls, plumbing or personal injury during installation.

TOOLS AND MATERIALS:



Safety Glasses

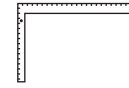

Framing Square



Pencil



Tape Measure



Level



Hacksaw



Thread Sealant



Wood Shims

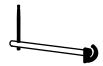

Basin Wrench



Drill

**Sealant - We recommend the use of neutral cure silicone caulk or a general purpose silicone sealant.

REVISED 05/21/2020

CODES: 235071, 394967, 235076, 521885
235066, 521886, 521887, 394968, 521877
521880, 421036, 521878, 421033, 421032
521879, 521881, 476578, 506954, 506951
292232, 506950, 506922, 507125

For Warranty information, please visit: signaturehardware.com/services/warranty

COPPER FARMHOUSE SINK

WITH VINE DESIGN

SKU: 915858, 926763, 926765, 926764, 909167, 908073, 937090

INSTALLATION OPTIONS

We recommend undermount sink installation. Flush-mount and built-up installation are not recommended.

Ensure there is adequate room for the faucet and backsplash installations.

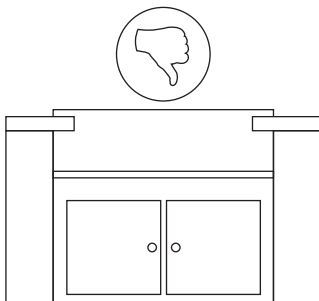
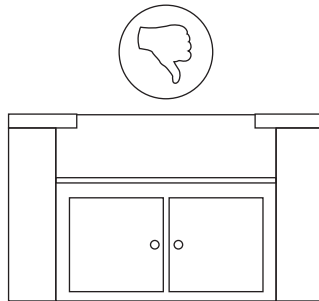
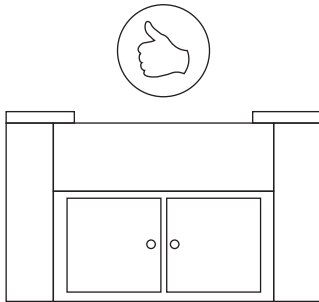

DRAIN INSTALLATION

Apply a bead of silicone sealant to the base of the strainer flange and place the flange in the drain opening in the sink.

If your drain has a disposer flange, use the directions supplied with the garbage disposer to attach the disposer and complete your installation. For drains with strainer baskets, slide the rubber gasket and friction washer up the strainer flange to the bottom of the sink.

Thread the lock nut onto the drain assembly. Hand-tighten and make sure that the drain is properly aligned. When ready, finish tightening with a basin wrench to secure the drain. Secure the P-trap to the strainer flange with the provided compression nut and ferrule.

COPPER FARMHOUSE SINK

WITH VINE DESIGN

SKU: 915858, 926763, 926765, 926764, 909167, 908073, 937090

PREPARE THE CABINET

Farmhouse sinks may require custom cabinetry. We recommend consulting an experienced cabinet maker for assistance. Providing the cabinet maker with the actual sink that is to be installed will ensure a custom fit.

Allow clearance for the water supply lines, drains and a garbage disposal, if applicable. Build a support frame or install support bars from front to back along the inner sides of the cabinet. The frame must support the weight of the sink and all attachments.

The support frame should be positioned so that when installed, the sink is in line and level with the top of the cabinet.

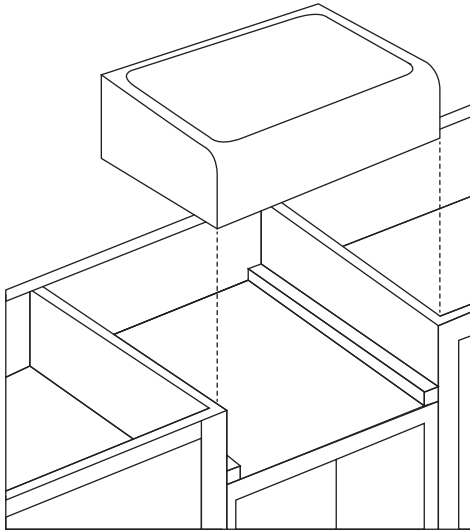

TEMPLATE AND CUTOUT

No template is provided since each sink will vary dimensionally. After centering the sink, trace the outline of the sink on the counter-top with a pencil to use as a guide for the cutout. Remember to allow clearance for any faucets and/or backsplashes. Cut the counter-top accordingly.

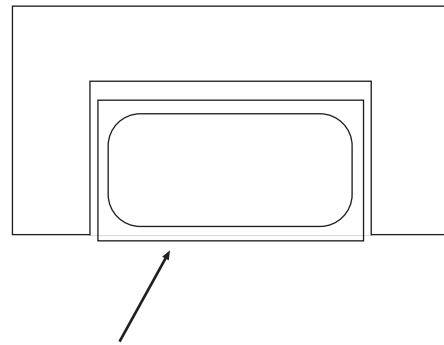

FINAL PLACEMENT

Test fit the sink in the opening that was created in the previous steps. The entire weight of the sink should be supported by the support frame. Verify that the sink is in line and level with the top of the cabinet. Use shims, if needed, to level the sink.

Set the sink and apply your sealant to fill in any gaps below the sink front, and between the sink and counter-top. Hold the sink in place to secure. Place the counter-top onto the sink and remove any excess sealant from all surfaces.

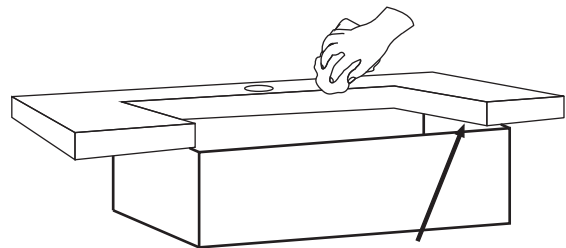

COPPER FARMHOUSE SINK

WITH VINE DESIGN

SKU: 915858, 926763, 926765, 926764, 909167, 908073, 937090

CLEANING AND MAINTENANCE

To protect a copper finish, it is recommended that a coating of wax is applied to the surface. Most wax products have natural and added UV filters that help guard against color and finish degradation. Wax should be applied as often as necessary, depending upon usage.

It is recommended that you use a cleaner or polish that is designed specifically for copper products. You may use a gentle soap, such as dish washing liquid and warm water. We recommend the use of a soft sponge or microfiber washcloth. Do not use any abrasive cleaning pads or materials. Rinse with warm water and dry with a clean, soft cloth.

Acidic cleaners, such as lemon juice and vinegar, will strip the antique finish from the copper. Mixtures containing acidic chemicals should be avoided to preserve the finish.

Epsom, or bath salts, should not be used in copper tubs, as they will tarnish and corrode the copper's appearance.

HOW COPPER AGES

Patina, often referred to as a "living finish," is a naturally occurring tarnish that develops over time as copper is exposed to natural elements, such as water and air. When your copper begins its patina process depends on where, how, and how often the copper is used. For example, a copper kitchen sink which is used countless times daily will patina a bit differently than a copper soaking tub which is only used on occasion. Copper living outdoors will also patina differently than indoor copper, developing a pale green tint over time due to chemical reactions with rain and/or salt water. The great benefit of copper is that it will never rust or corrode. The look of the copper will change over time; however, its rigidity will stay intact.