

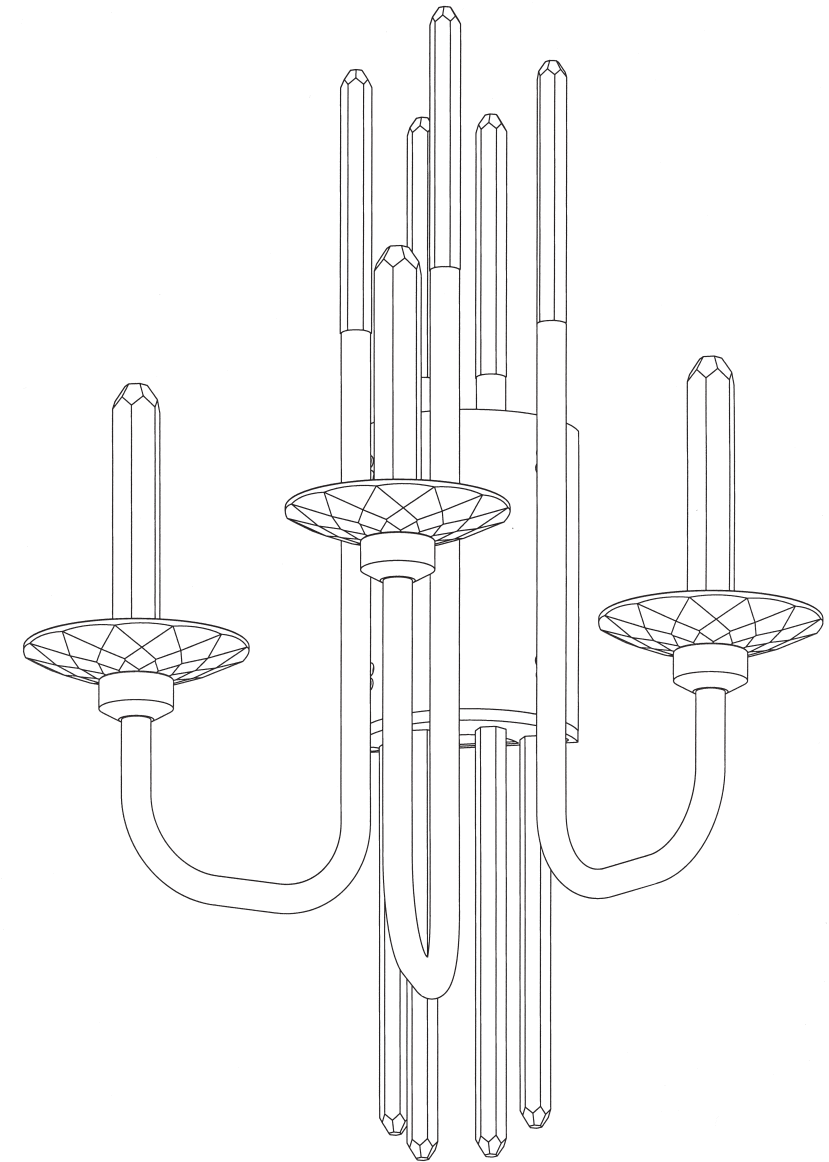









SCHONBEK
Signature[™]

CALLIOPE
S5703- __ __ O



THIS DESIGN IS THE PROPRIETARY
TRADE DRESS/TRADEMARK OF
W SCHONBEK LLC.

SCHONBEK
Signature[™]

								
MAX 11 W	110-120 V							

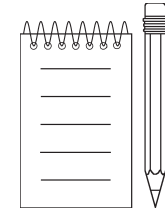
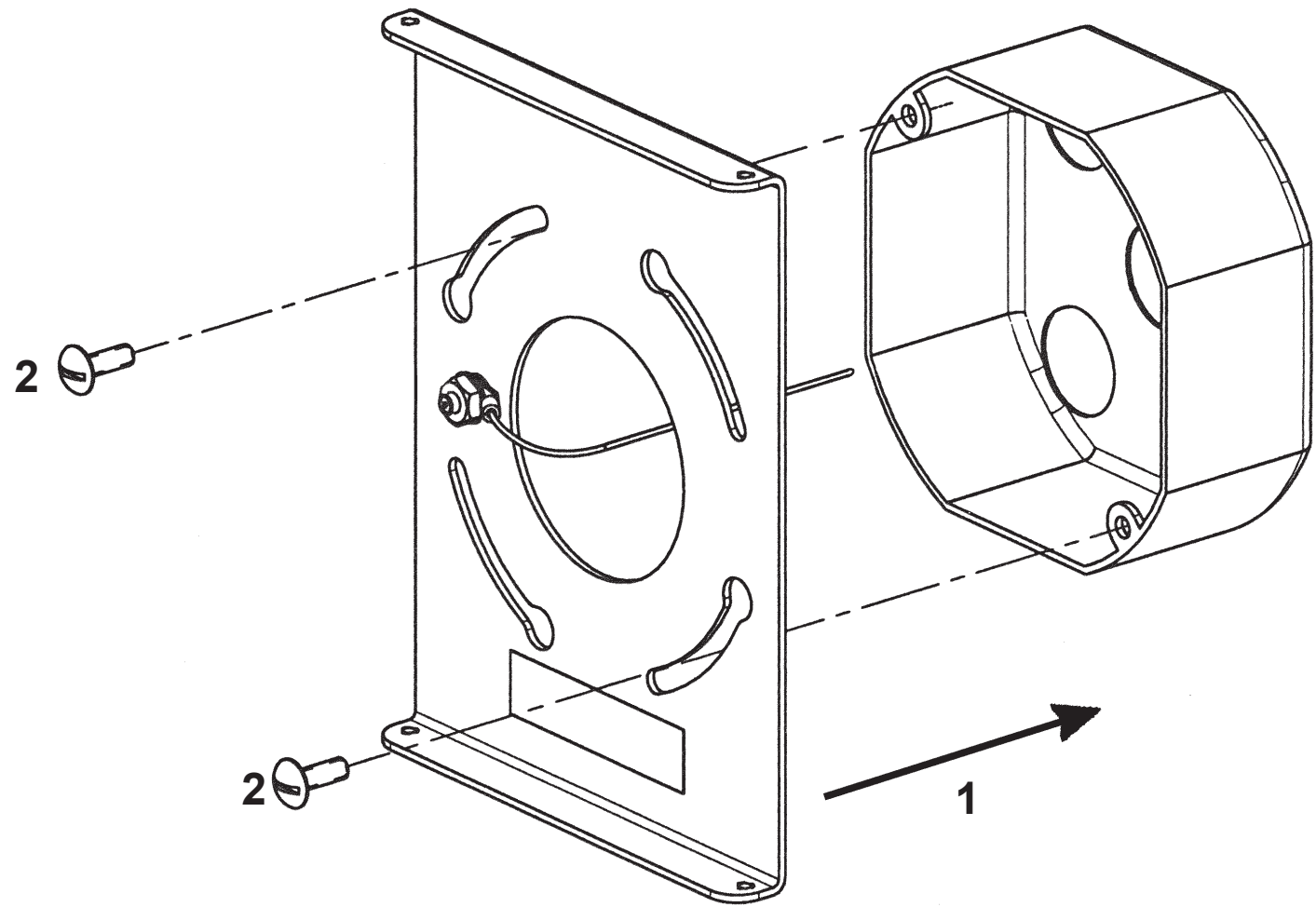
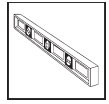



3 SELECT DESIRED LED
COLOR TEMPERATURE
**NOTE: FIXTURE POWER MUST
BE OFF BEFORE CHANGING
THE CCT SETTING.**

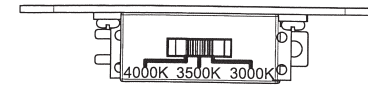

3000K = WARM
3500K = WARM/NATURAL
4000K = NATURAL

