



SCHONBEK®

RENAISSANCE 3769- _ _ _



THIS DESIGN IS THE PROPRIETARY TRADE DRESS/TRADEMARK OF SWAROVSKI LIGHTING, LTD.

5 Lights
Diameter: 14-1/2"
Body Length: 19"
Hanging Weight: 10 lbs.



SCHONBEK®

MAX <u>60</u> W		110-120 V						

SCHONBEK® is a member of the Swarovski group.

All electrical components must be installed by a licensed electrician in accordance with the National Electric Code and the appropriate local electrical codes.

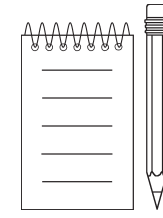
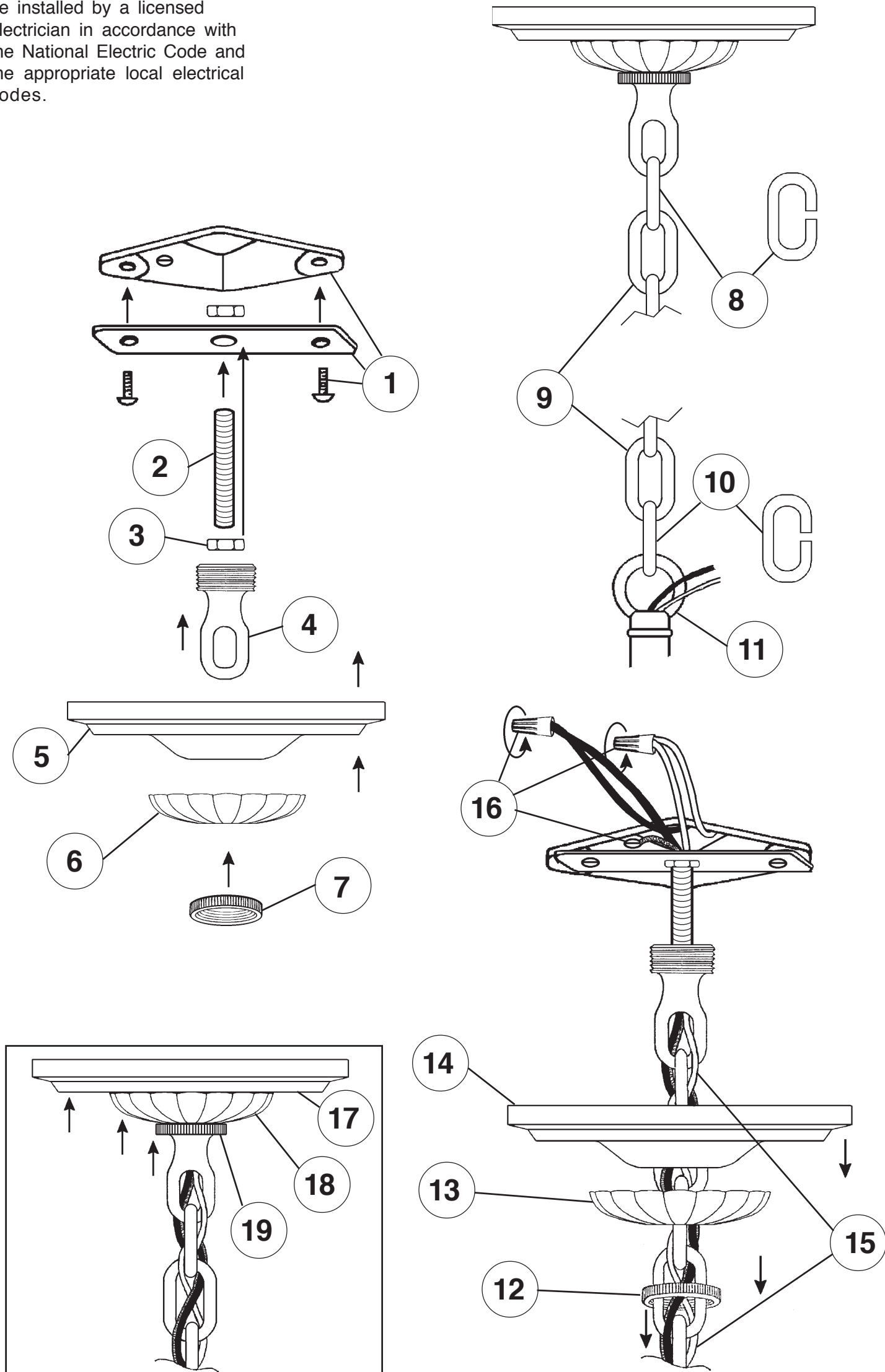

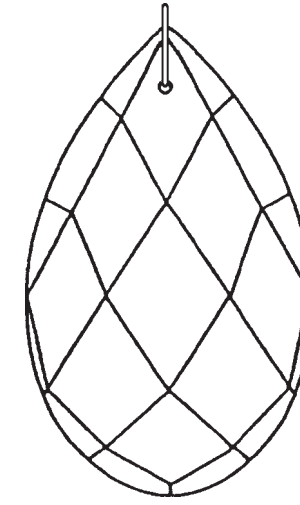

N4032
2-1/2"
63mm

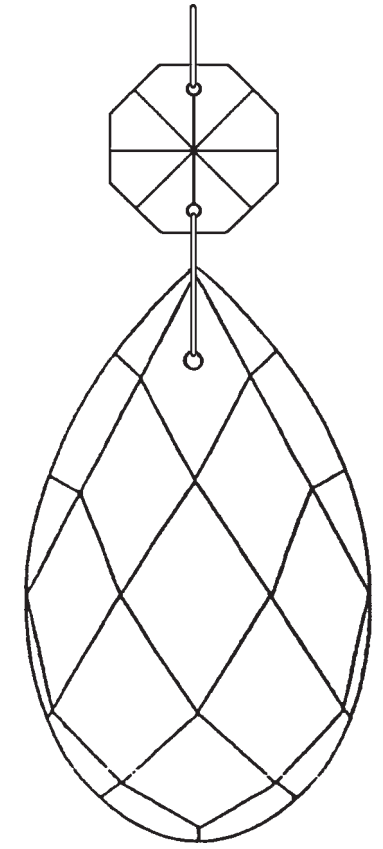

N4000
3"
76mm

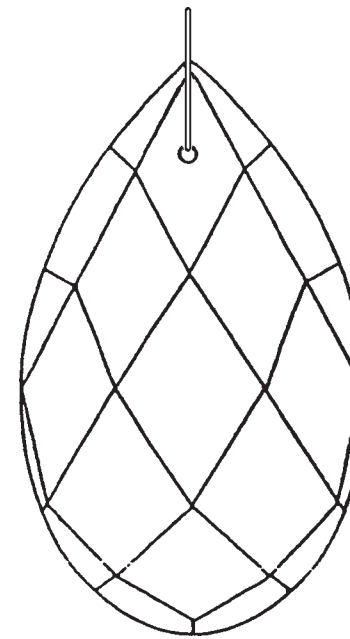

N4004
3"
76mm

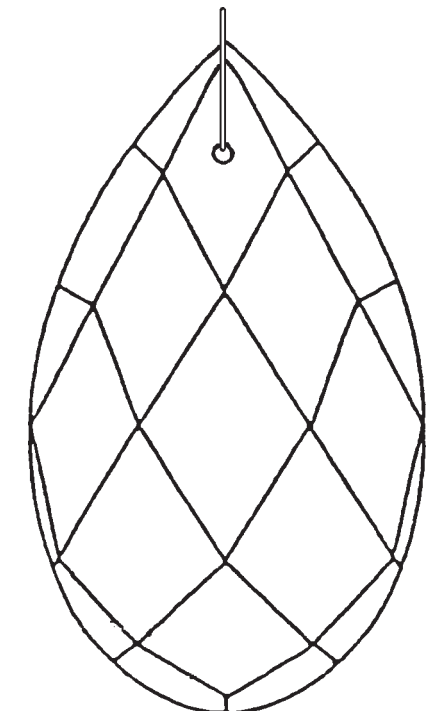

N4001
3-1/2"
89mm

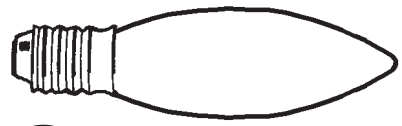

21 5 - B10
60 Watts Max
25 Watts Recommend

