

SCHONBEK®

CHANDELIER 6309- _____ TRIM DIAGRAM

(Finish Option) (Trim Option)



THIS DESIGN IS THE PROPRIETARY
TRADE DRESS/TRADE MARK OF
SCHONBEK WORLDWIDE LIGHTING INC.

9 Lights
Diameter: 31"
Body Length: 31"

SCHONBEK®

This fixture was designed and manufactured in Plattsburgh, N.Y. Our high-quality crystal fixtures are made with state-of-the-art manufacturing equipment. If you have any questions about this or any of our more than 450 crystal products, contact your nearest authorized Schonbek distributor.

CAUTION... RISK OF ELECTRICAL SHOCK. Make sure the electrical supply to the chandelier is turned off at the main fuse or circuit breaker before doing any installation. All electrical components must be installed by a licensed electrician in accordance with the National Electric Code and the appropriate local electrical codes.

HANGING WEIGHT: 36 pounds.

BULBS: (9) Candle shaped candelabra base C10 bulbs, recommend 25 watts for best appearance.
60 - Watts Maximum

WARNING: This chandelier meets UL/CSA requirements. Any tampering will void UL/CSA certification.

Follow steps in exact order
Save this trim diagram for future reference

1

IMPORTANT

Please record the following information for future service.

CODE # _____ Four-digit number on outside of carton.
PACKER # _____ See crystal package label.
ORDER # _____ See crystal package label.

Instructions for electrician
STEPS 2 - 18

WARNING:

2

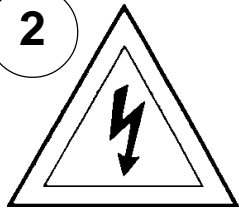

Electrical Danger

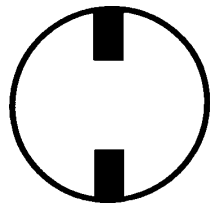

Turn Power Off

All electrical components must be installed by a licensed electrician in accordance with the National Electric Code and the appropriate local electrical codes.

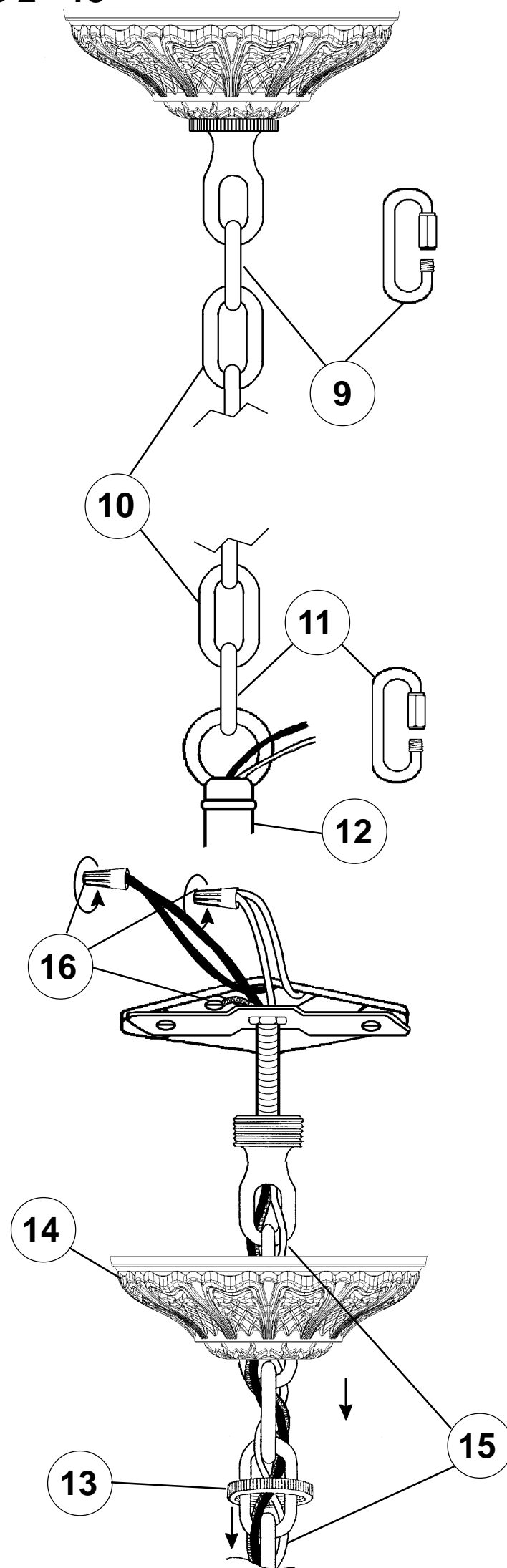
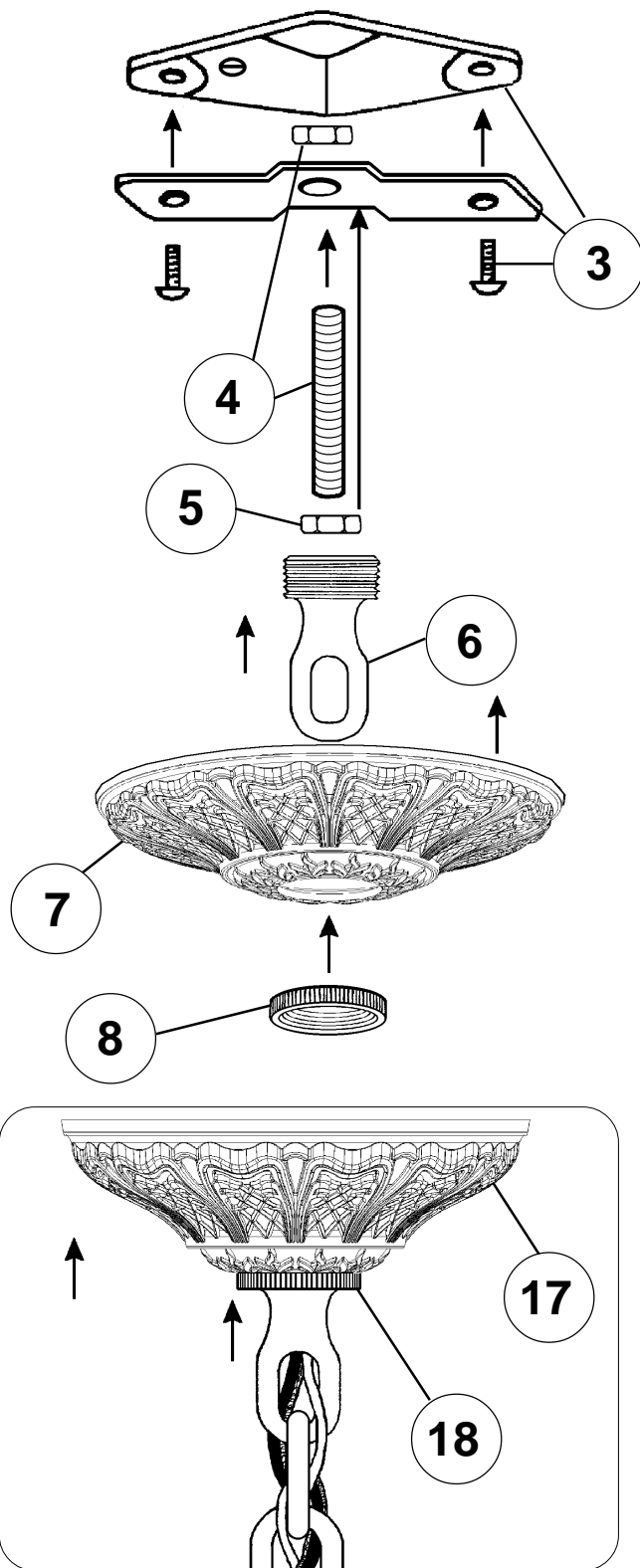

FRAGILE:

CAUTION:

Glass parts are fragile. To avoid breakage use care when assembling or cleaning.

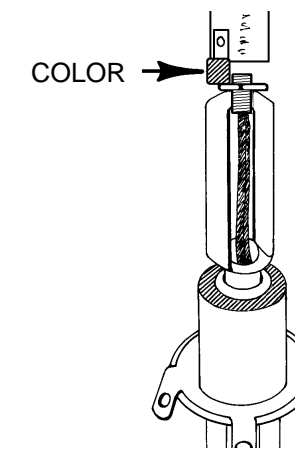

**WHEN ORDERING
REPLACEMENT ARM(S):**

- Give arm number from trim diagram
- Give color code from the arm itself

MAINTENANCE:

Use a soft, lint - free cloth to clean the metal frame.

UNDER NO CIRCUMSTANCES SHOULD METAL POLISHES, CLEANERS, ABRASIVES OR AEROSOL SPRAYS BE USED.

While the latest finishing techniques have been used on the metal frame, such finish cannot be unconditionally guaranteed. The main cause of deterioration, apart from certain atmospheric conditions, is improper cleaning.

To clean the crystals, polish with a damp chamois.

You are cleaning delicate jewelry... Take the greatest care.

IMPORTANT:

Do not clean crystals in a dishwasher. The finish of the metal clips and hangers will be ruined and the crystals may be damaged.

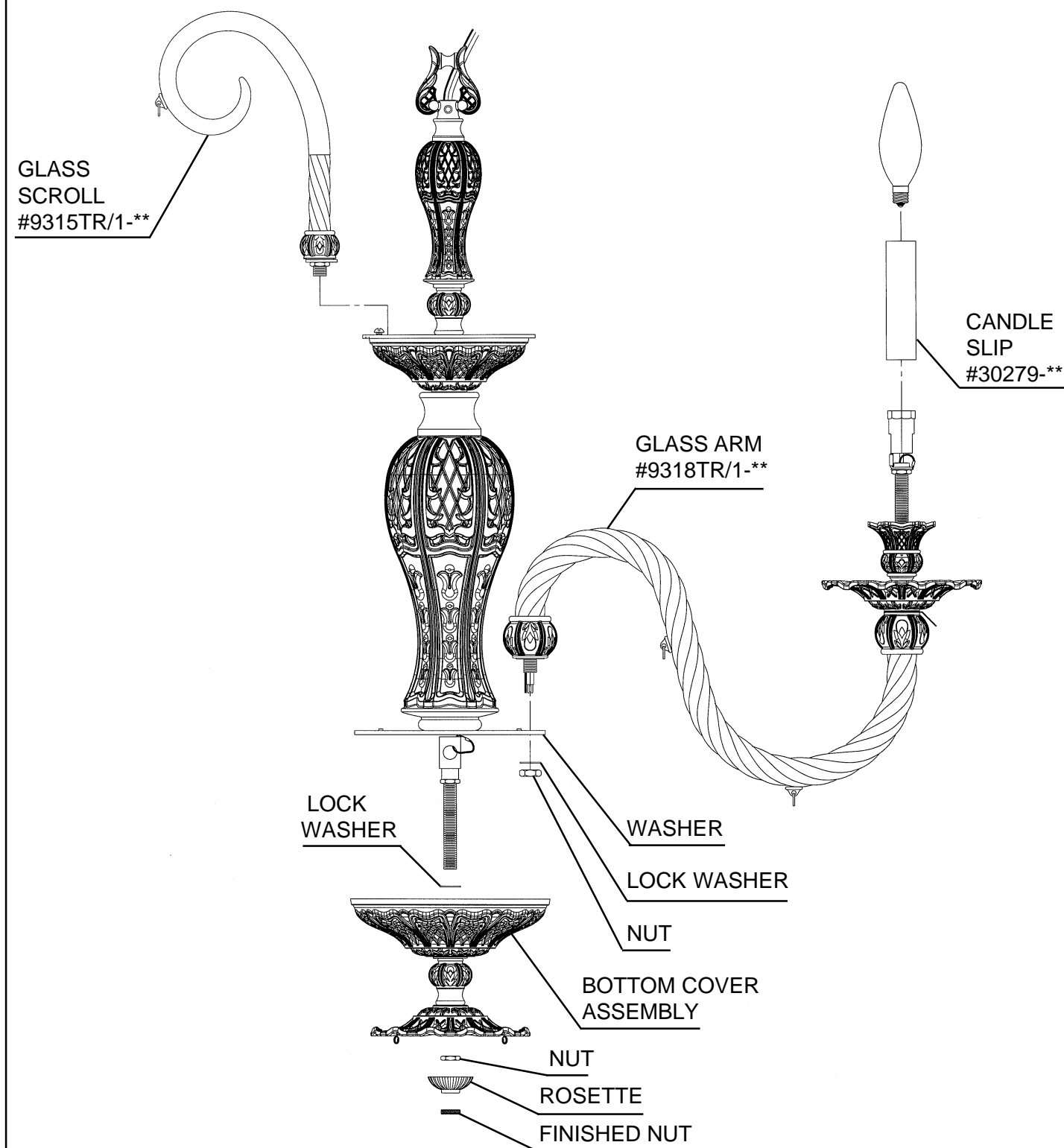

19 Install scrolls into washer with screws provided. NOTE: Scrolls should be aligned between arms. Install arms into large arm washer. Line up holes in arms with dimple in washer. Use lock washer and nut to secure arms in place.

20 Connect bare ground wires in each arm to bare ground wire in center column. Use electrical tape to secure wire nuts. NO MORE THAN 5 - WIRES PER WIRE NUT. Sufficient quantities of jumper wires and wire nuts are provided.

21 Connect white arm wires to neutral column wire (ribbed or marked is neutral). Connect black arm wires to power wire in column. Carefully press wires as close as possible to the underside of washer. Install lock washer and bottom cover assembly with nut. Complete assembly with rosette and finished nut.

22 Install bulbs, connect power and test the fixture BEFORE trimming. If any of the bulbs do NOT light - DISCONNECT POWER. Double check the wire connections.

Instructions for crystal trimming STEPS 23 - 37



You will need 9 - C10
25 Watts Recommended
60 Watts Max

23

Install bulbs and be
sure to test fixture
BEFORE trimming.

DIAGRAM #1

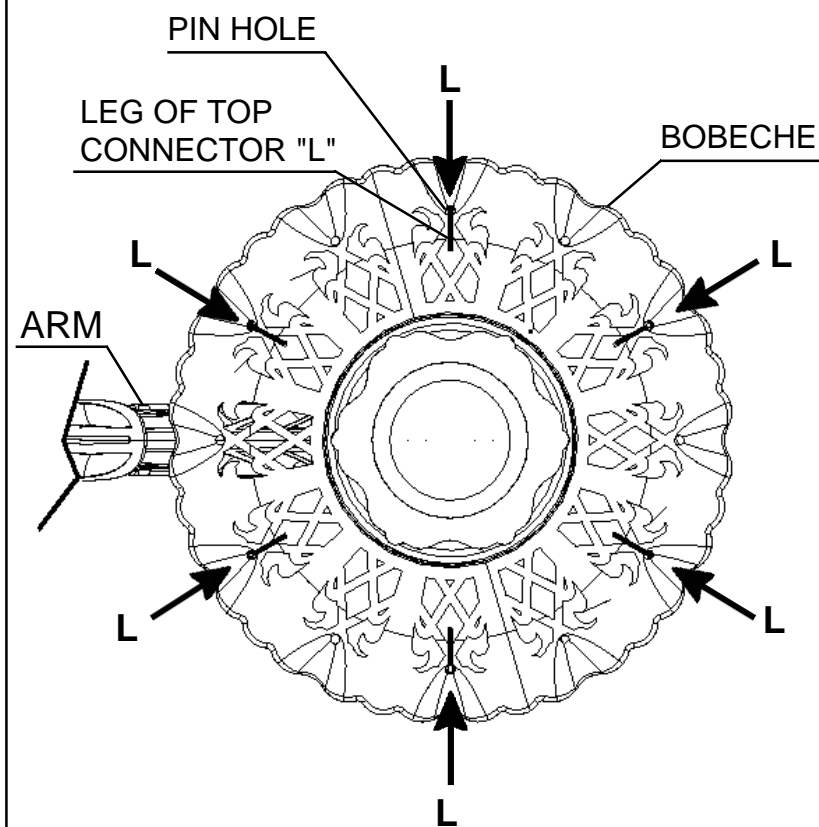

When trimming bobeche with letter "L", insert leg of top connector into pin hole from under bobeche. Hang in every other pin hole starting on either side of the arm (refer to Diagram #1)

