

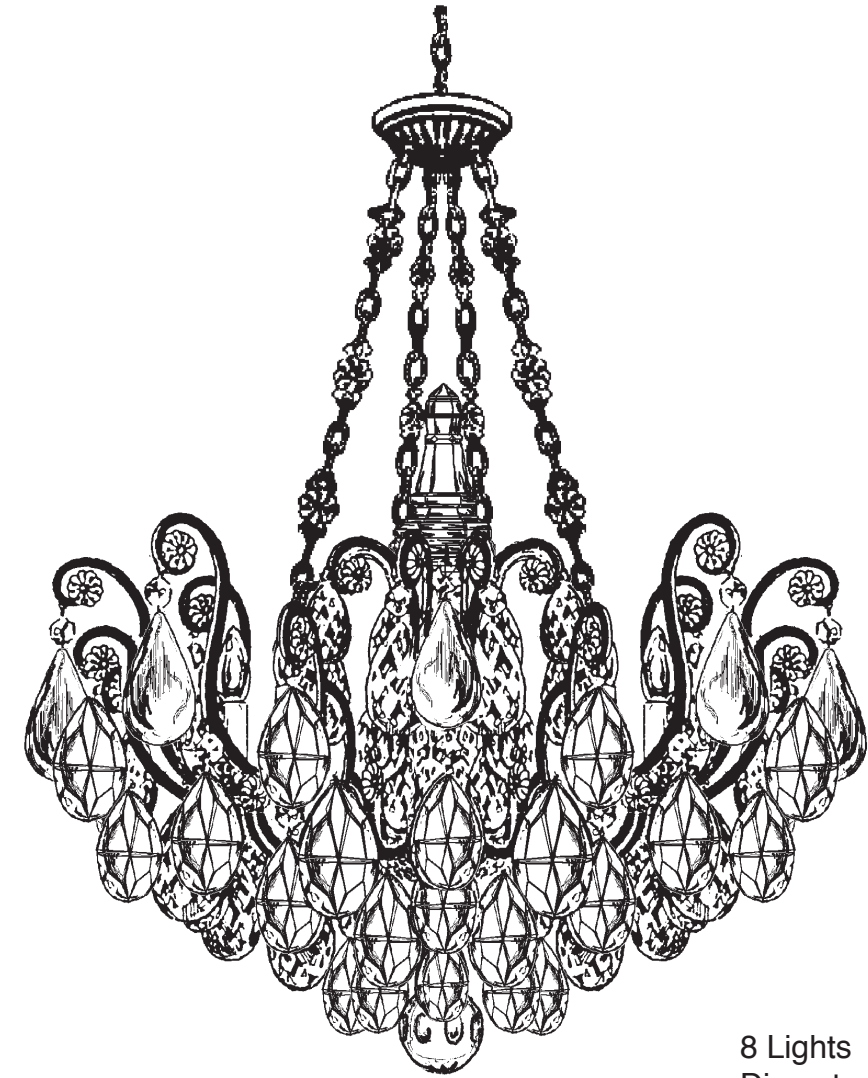

**SCHONBEK®**

**RENAISSANCE 3587- \_\_\_\_\_**



**T**HIS DESIGN IS THE PROPRIETARY  
TRADE DRESS/TRADEMARK OF  
SWAROVSKILIGHTING, LTD.

8 Lights  
Diameter: 26-1/2"  
Body Length: 35"  
Hanging Weight: 37 lbs.



**SCHONBEK®**

MAX <b>60</b> W		110-120 V						

SCHONBEK® is a member of the Swarovski group.

All electrical components must be installed by a licensed electrician in accordance with the National Electric Code and the appropriate local electrical codes.

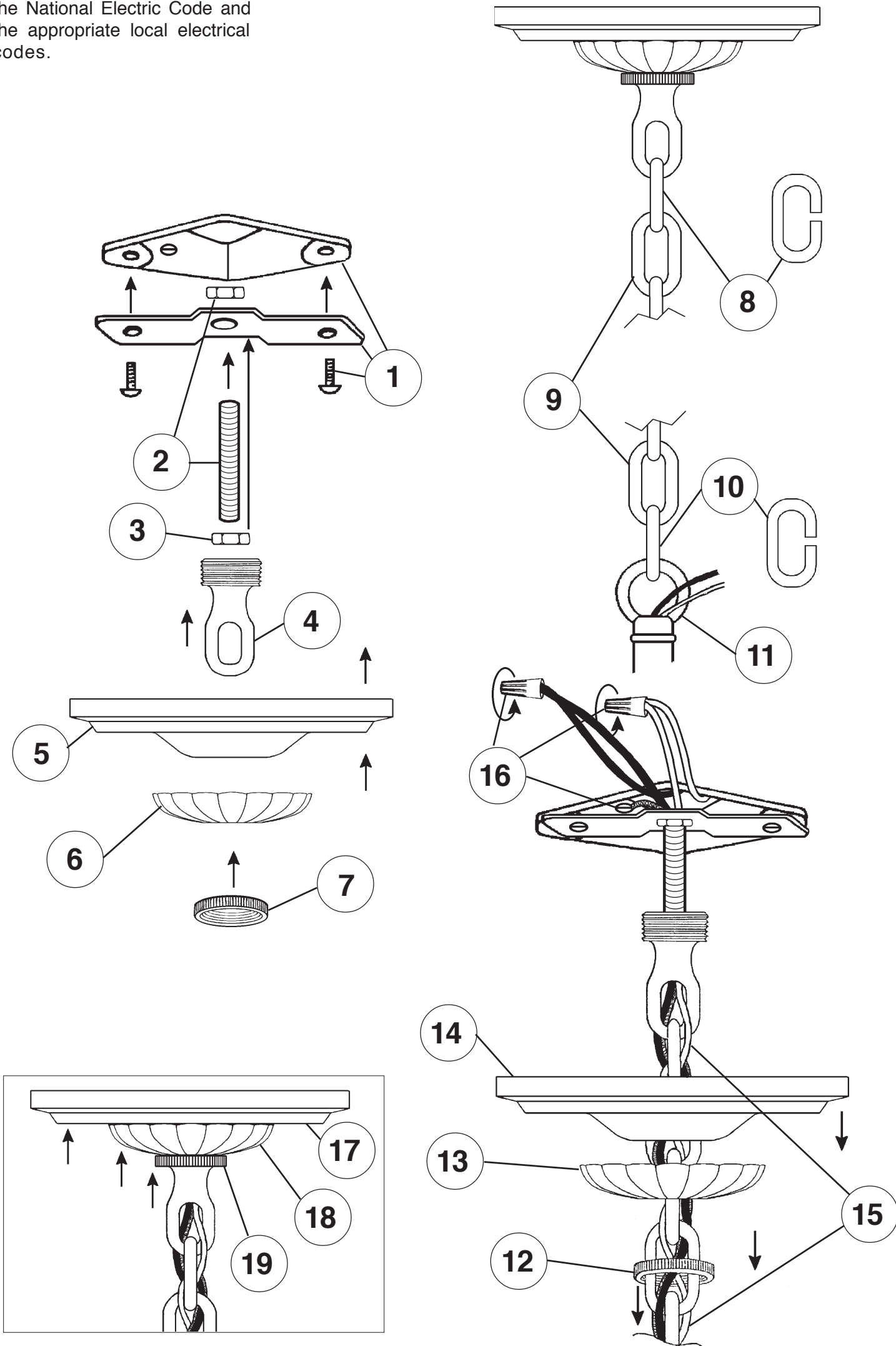

**Crystal Set #3 in Black**

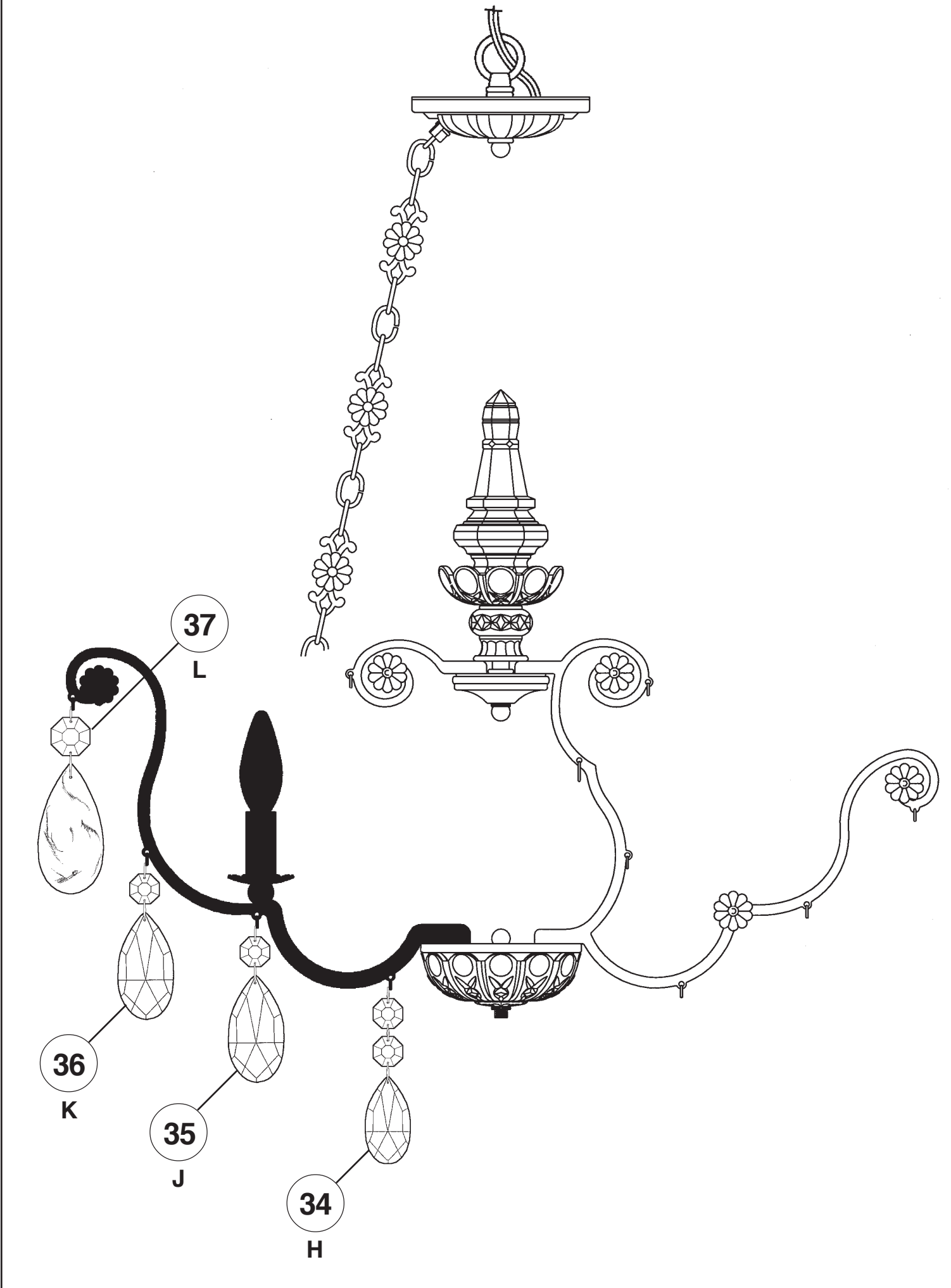

**SET #1**

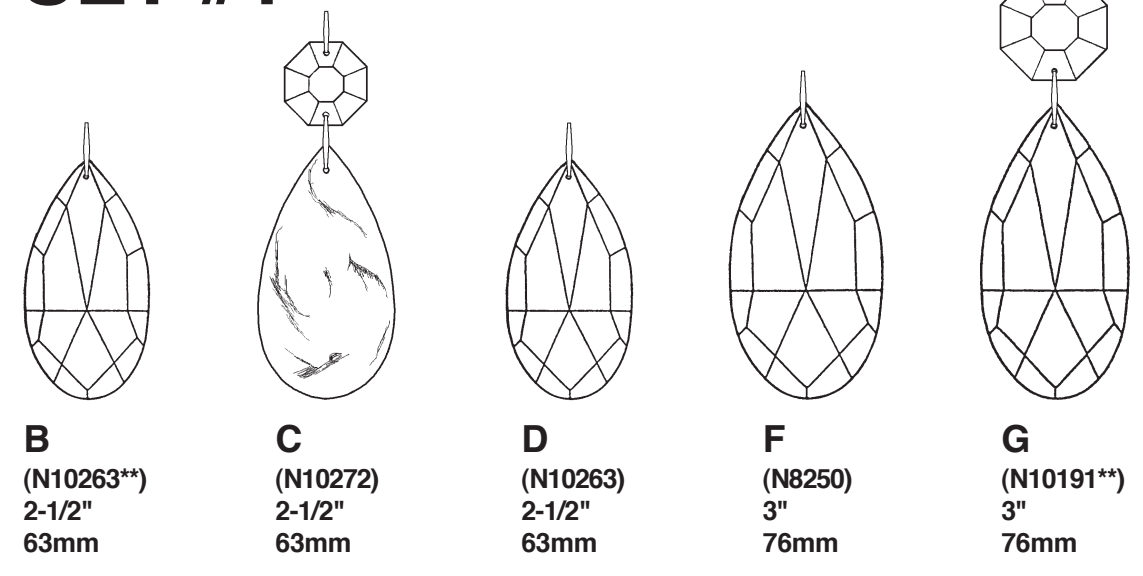

**SET #2**

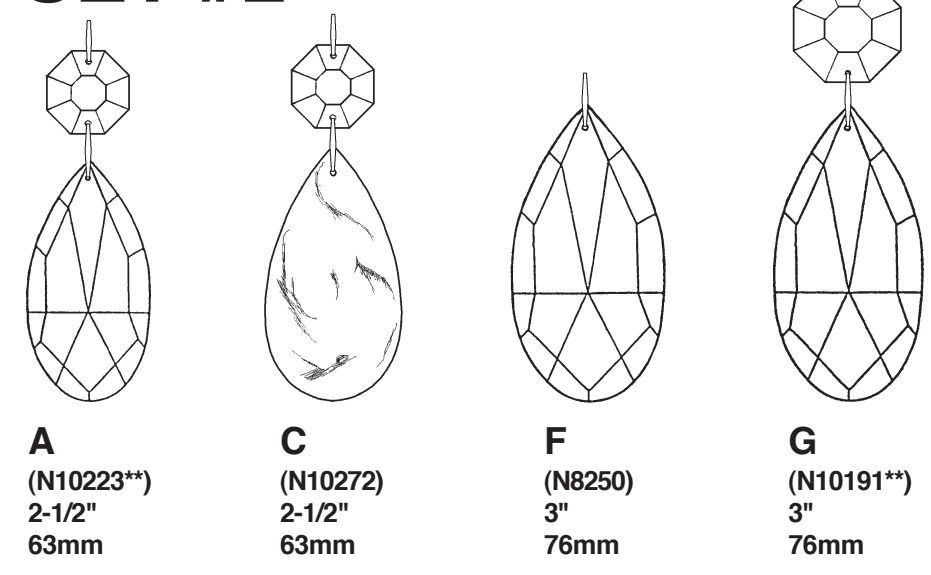

**SET #3**

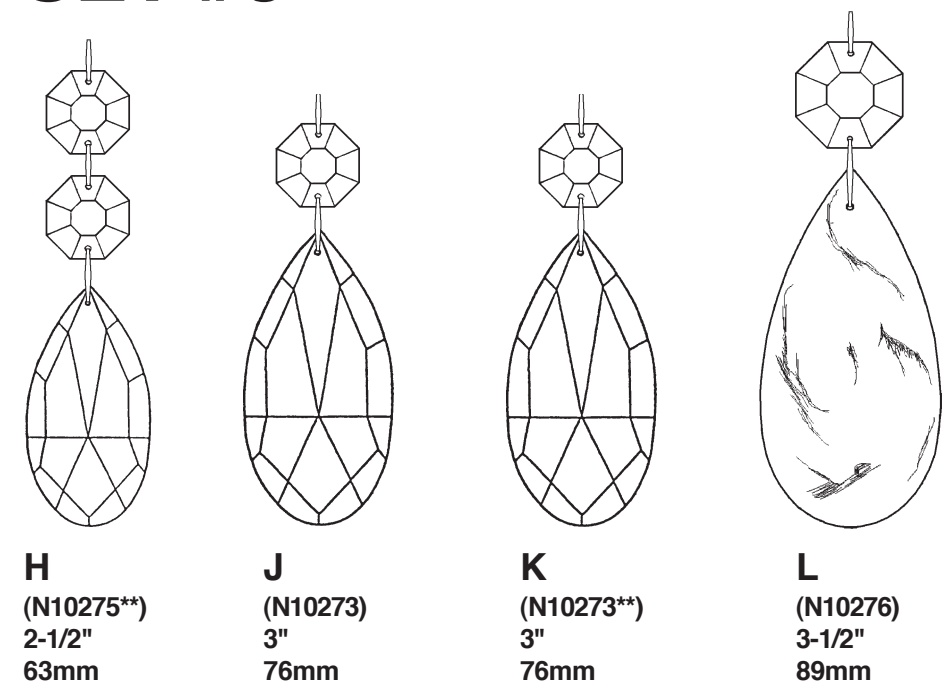

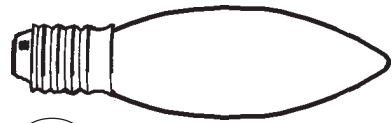

20

You will need 8 - B10  
25 Watts Recommended  
60 Watts Max

Install bulb and be sure  
to test fixture **BEFORE**  
trimming.

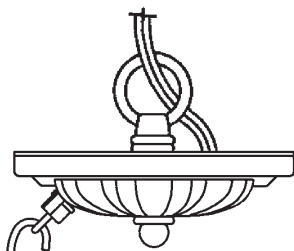

Crystal Set #1 in Black

21

9552/150

24

C

22

B

23

D

28

F

27

C

25

N1240-\*\*

Crystal Set #2 in Black

9302

9419

30

A

9319

33

G

32

F

31

C

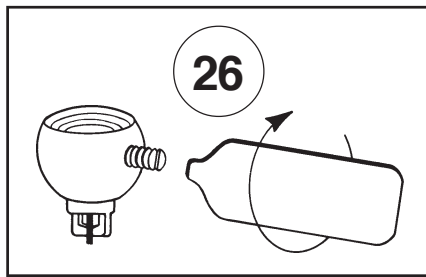

26

