

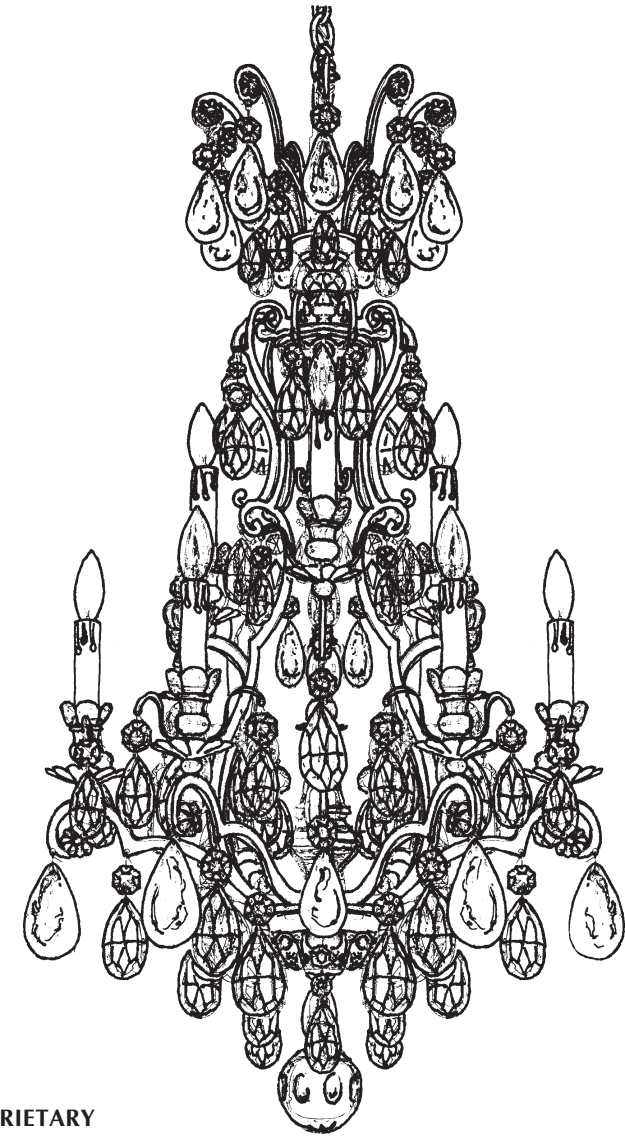

SCHONBEK®

RENAISSANCE 3580- _____



9 + 1 Lights
Diameter: 21"
Body Length: 40"
Hanging Weight: 38 lbs.

THIS DESIGN IS THE PROPRIETARY TRADE DRESS/TRADemark OF SWAROVSKI LIGHTING, LTD.



SCHONBEK®

MAX 60 W	MAX 15 W	110-120 V						

SCHONBEK® is a member of the Swarovski group.

All electrical components must be installed by a licensed electrician in accordance with the National Electric Code and the appropriate local electrical codes.

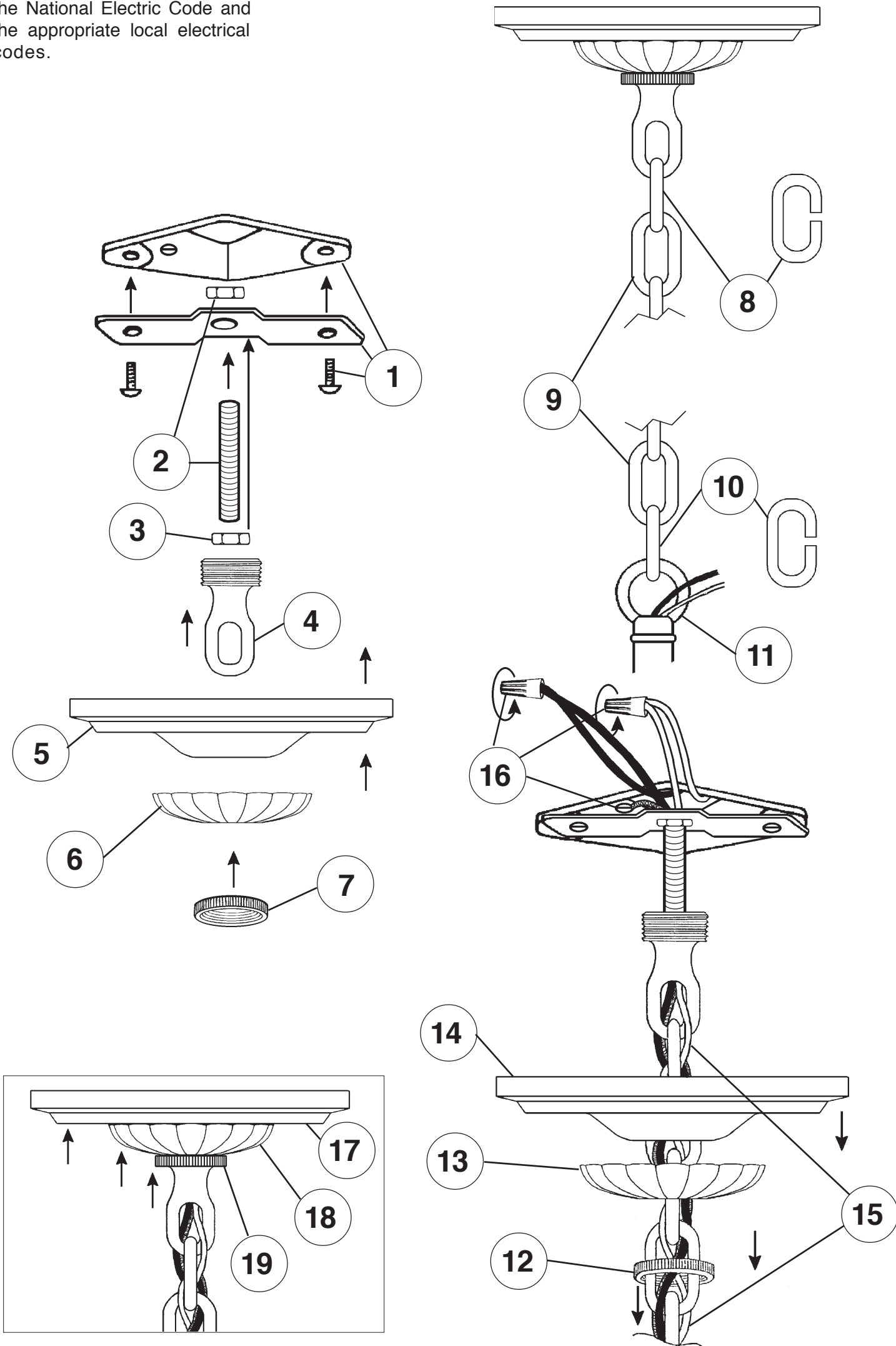

Crystal Set #3 in Black

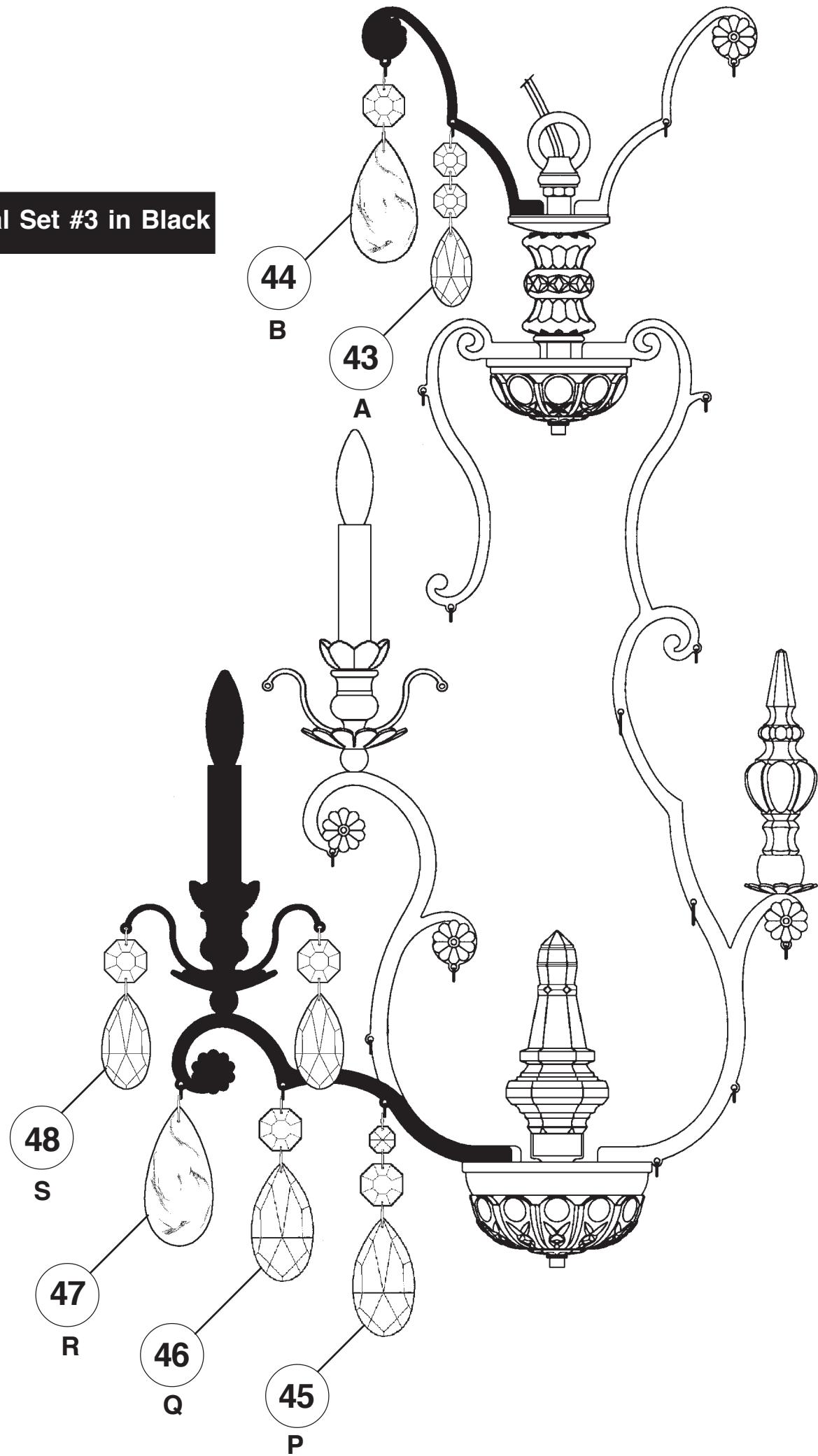

SET #1

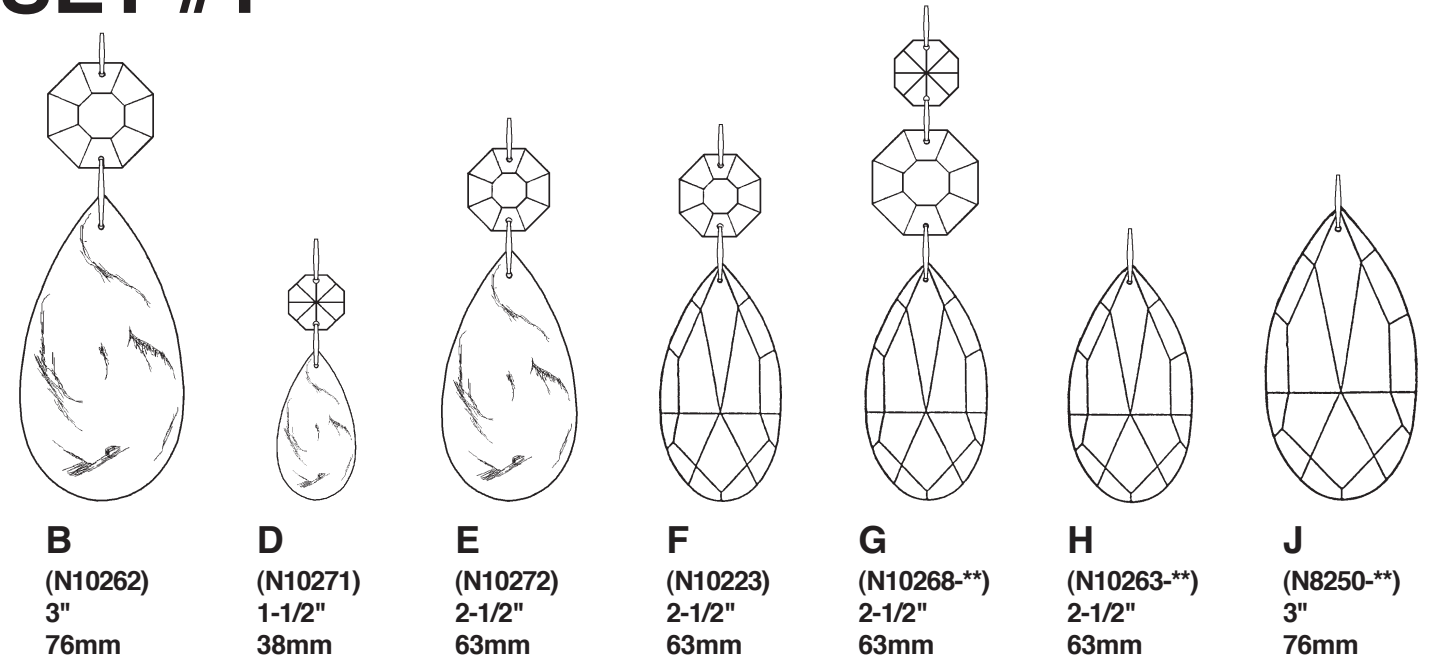

SET #2

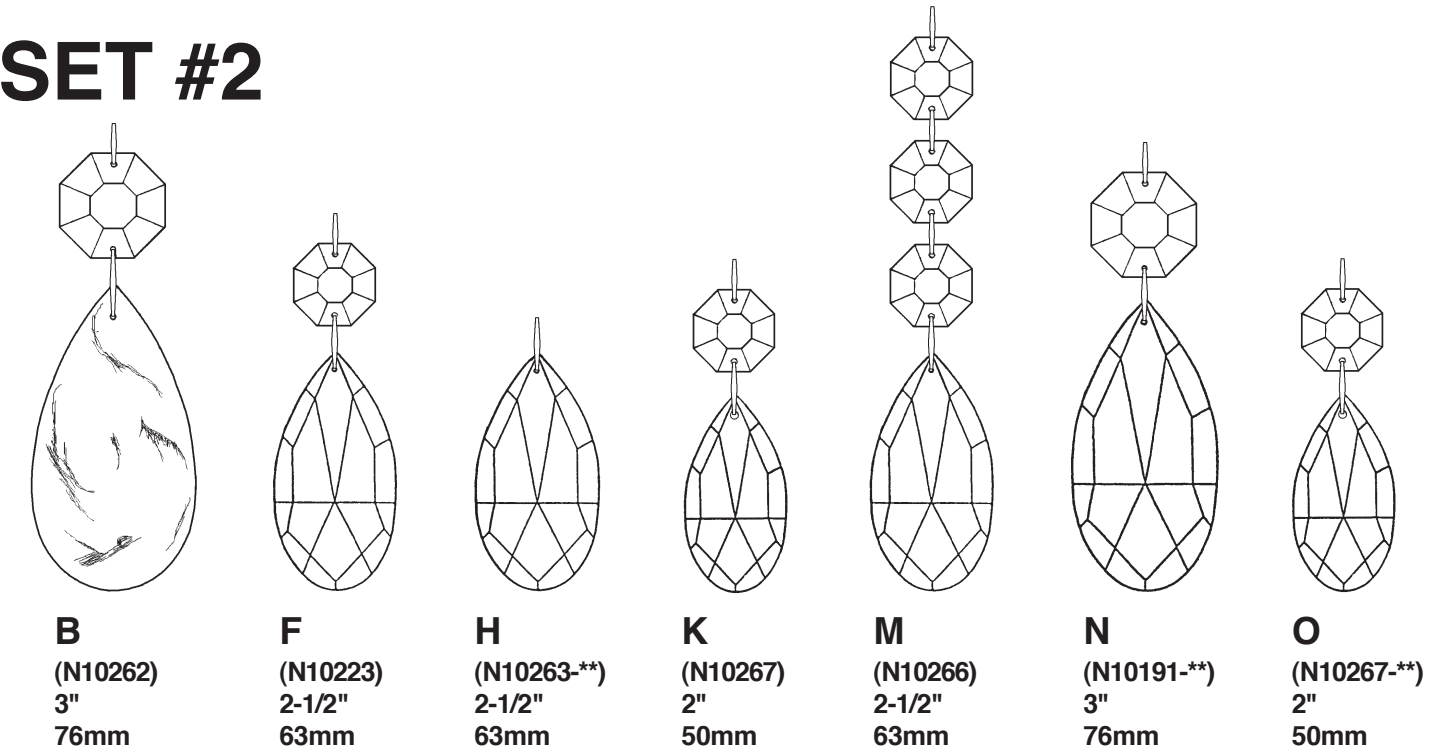

SET #3

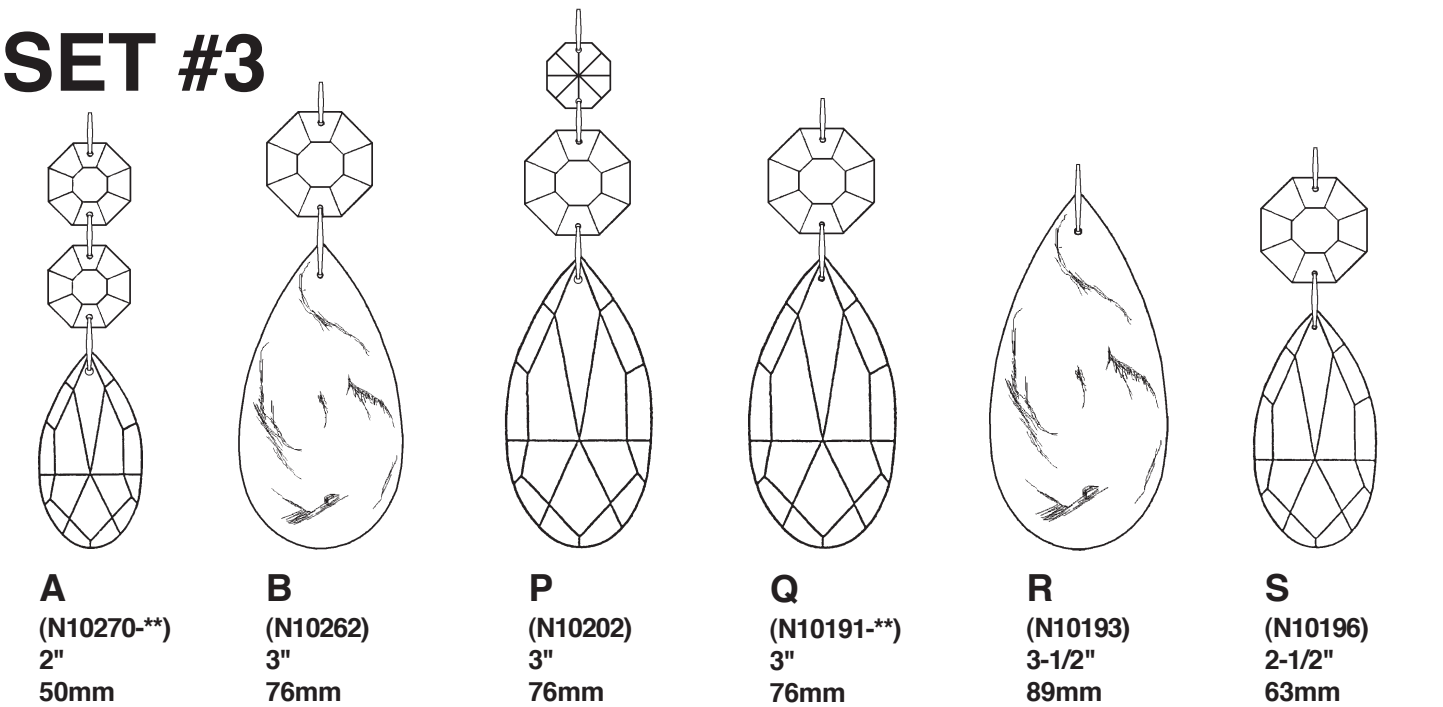

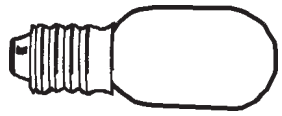

You will need 1 - T7
15 Watts Max
(Center Light)

21

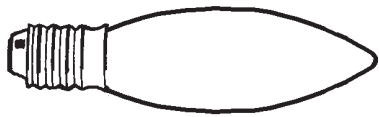

You will need 9 - B10
25 Watts Recommended
60 Watts Max

Install bulbs and be sure
to test fixture BEFORE
trimming.

20

90002

Crystal Set #1 in Black

25

Crystal Set #2 in Black

9418

9302/0

37

F

36

K

26

D

29

G

30

H

23

9551/150/1

24

N1245-**

27

E

22

9552/180

28

F

35

J

32

42

O

38

H

41

N

9319

40

B

31

N1246-**

33

G

34

B

39

M

