

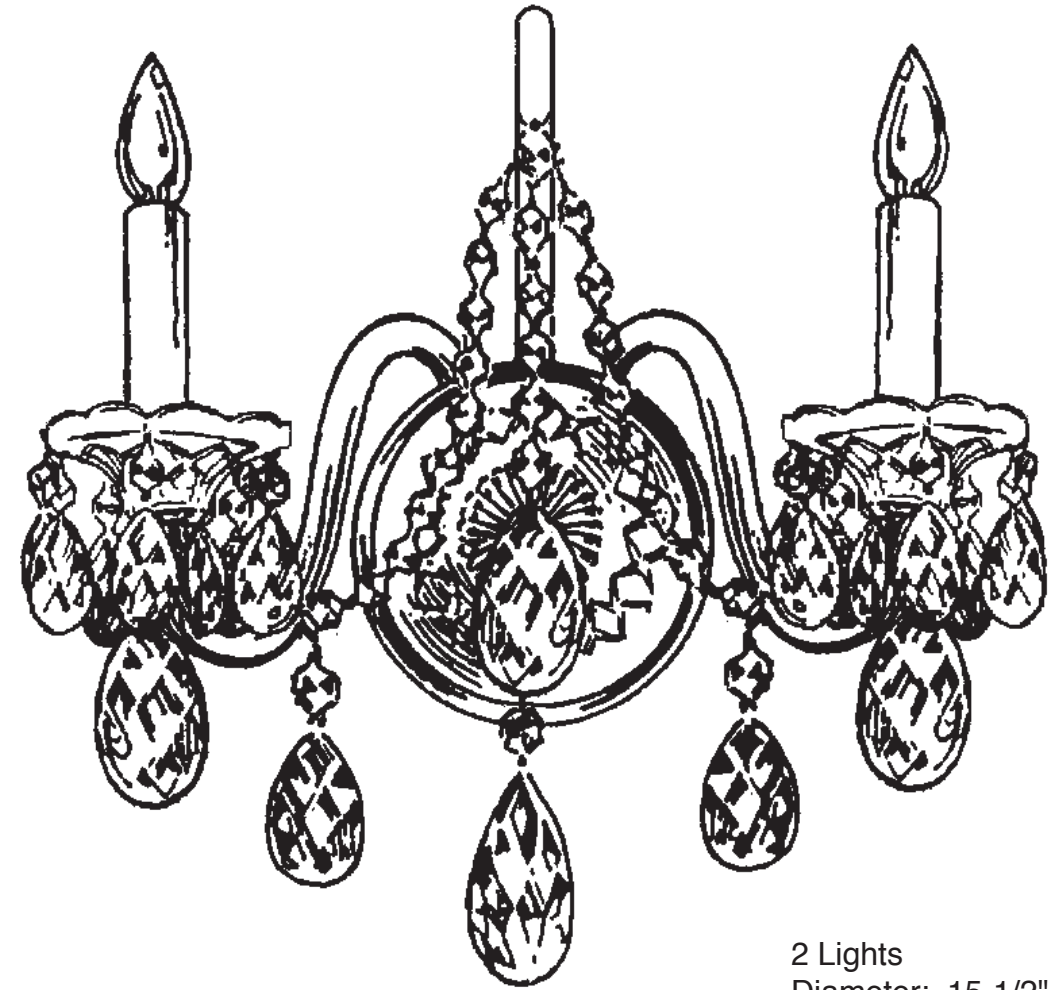

**SCHONBEK®**

**STERLING 2991- \_\_ \_\_ S**



2 Lights  
Diameter: 15-1/2"  
Body Length: 16-1/2"  
Extension: 6-1/2"  
Hanging Weight: 4 lbs.

**T**HIS DESIGN IS THE PROPRIETARY  
TRADE DRESS/TRADEMARK OF  
SWAROVSKILIGHTING, LTD.



**SCHONBEK®**

MAX <u>60</u> W		110-120 V					

SCHONBEK® is a member of the Swarovski group.

All electrical components must be installed by a licensed electrician in accordance with the National Electric Code and the appropriate local electrical codes.

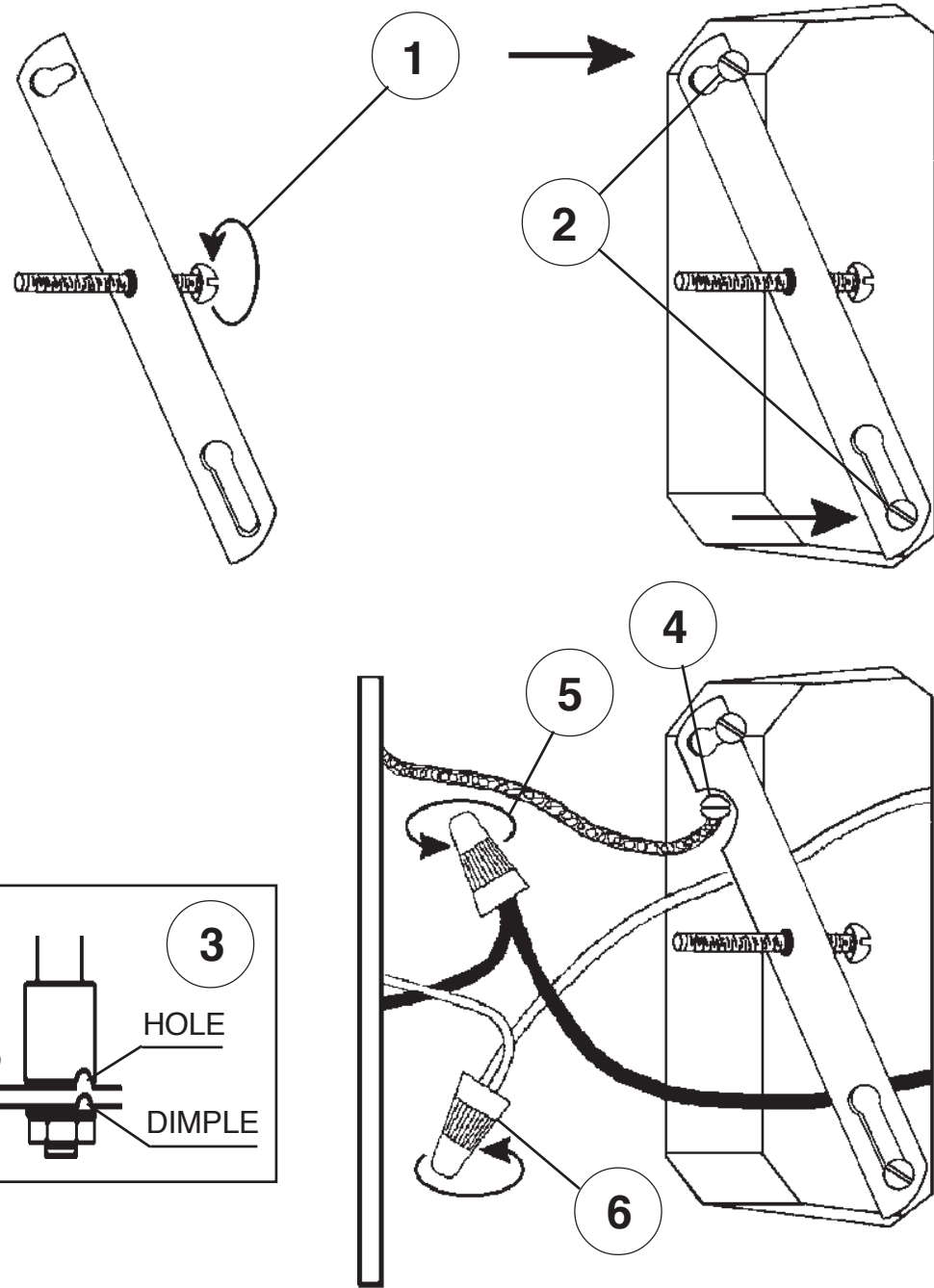

Turn arms to line up holes in arms with dimple in plate. Tighten lock washer and nut to secure arms in place.

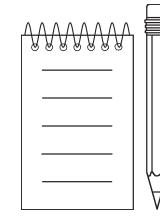
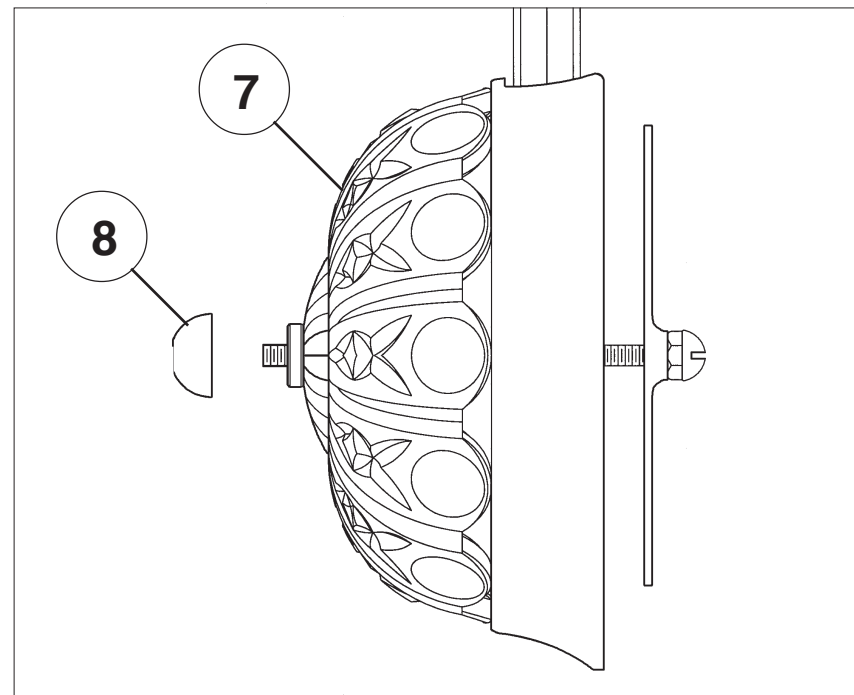
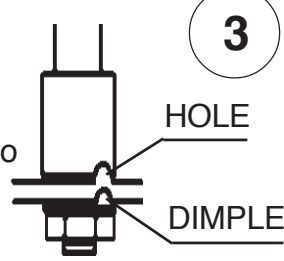

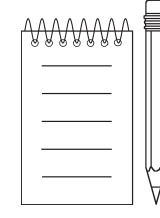
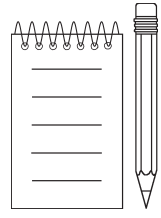



9

You will need 2 - B10  
25 Watts Recommended  
60 Watts Max

Install bulbs and be sure  
to test fixture BEFORE  
trimming.

