

SCHONBEK®

EQUINOXE 2724- _____
(Finish Option)
TRIM DIAGRAM

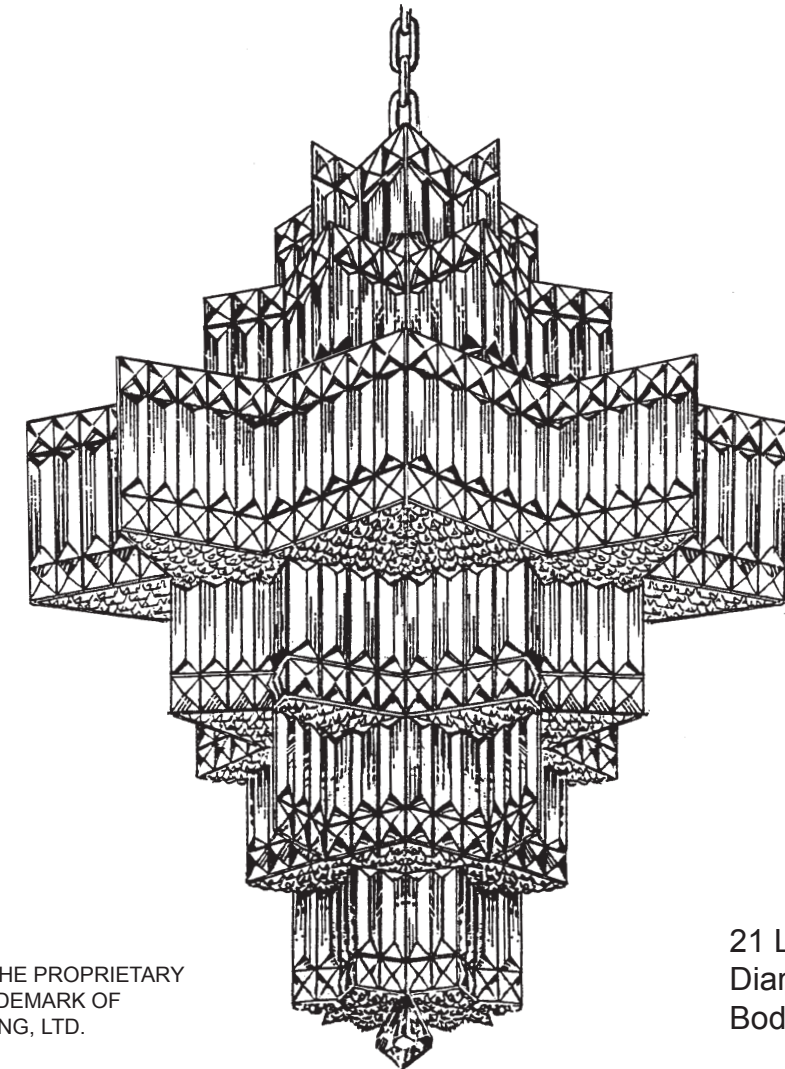

THIS DESIGN IS THE PROPRIETARY
TRADE DRESS/TRADemark OF
SWAROVSKI LIGHTING, LTD.

21 Lights
Diameter: 22-1/2"
Body Length: 28"

SCHONBEK®

CAUTION... RISK OF ELECTRICAL SHOCK. Make sure the electrical supply to the chandelier is turned off at the main fuse or circuit breaker before doing any installation. All electrical components must be installed by a licensed electrician in accordance with the National Electric Code and the appropriate local electrical codes.

HANGING WEIGHT: 40 lbs.

BULBS: 21 - Candle shaped candelabra base B10 bulbs, recommend 25 watts for best appearance.

60 - Watts Maximum

WARNING: This chandelier meets UL/CSA requirements. Any tampering will void UL/CSA certification.

IMPORTANT

Please record the following information for future service.

CODE # _____ Four-digit number on outside of carton.

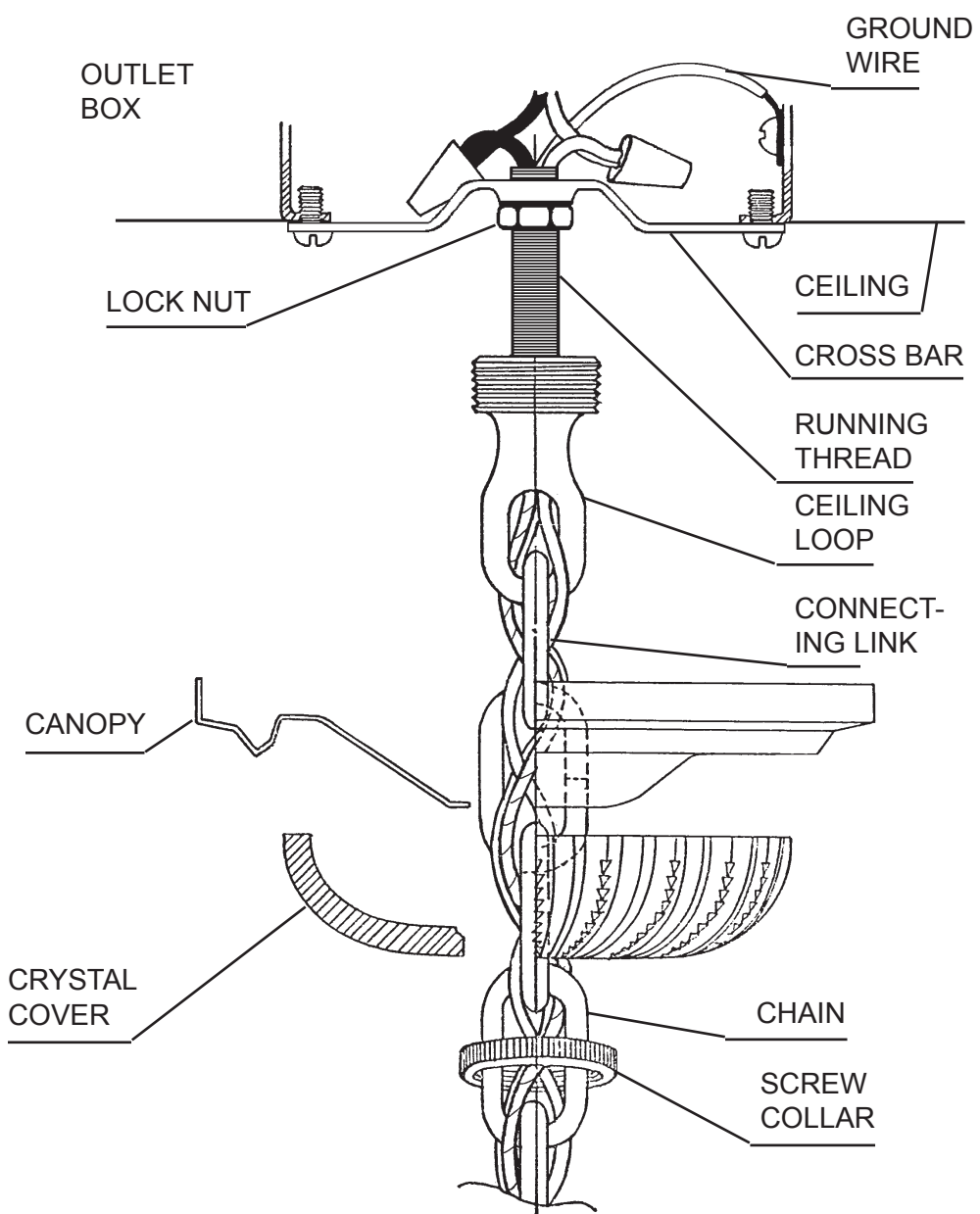

- 1 MAKE SURE POWER IS DISCONNECTED!!**
- 2** Attach crossbar to outlet box.
- 3** Slip screw collar, cover and metal canopy over chain. Determine the suspension length of the fixture and cut chain, if necessary. Use two connecting links to attach chain to chandelier loop and ceiling loop.
- 4** Insert stem wire through chain and ceiling loop. Connect wires. Fixture **MUST** be grounded.
- 5** Check distance from ceiling to loop to assure canopy assembly will be flush against ceiling. Attach canopy to ceiling with screw collar.
- 6** Install bulbs, connect power and test fixture before trimming.

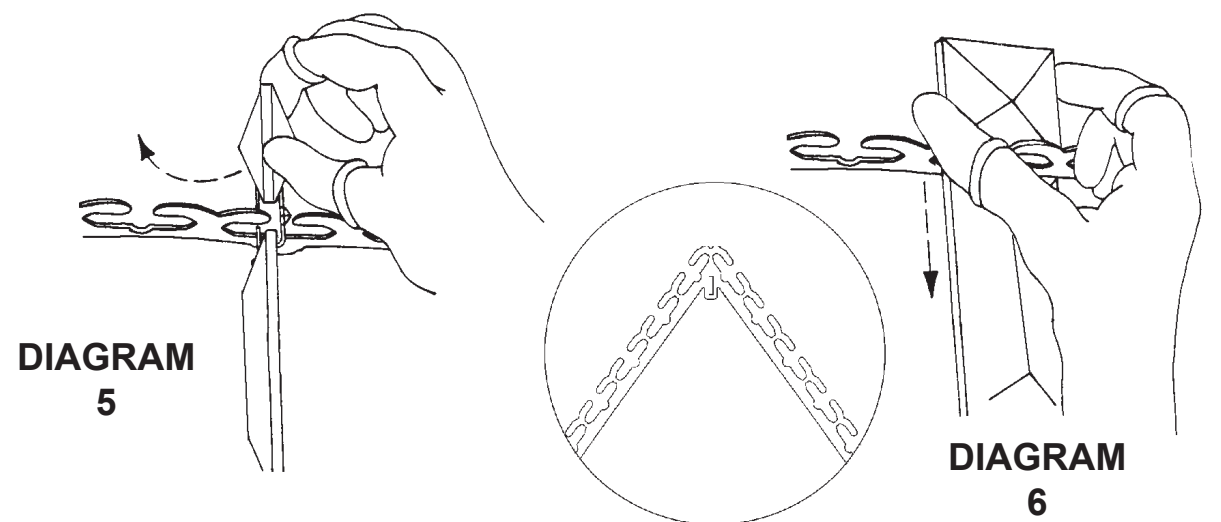

Installation of Crystals "A" and "C"

Hold onto small square stone end and turn chain side ways, this will allow connector (connector opening faces to the back) to pass through slot in ring. (Diagram 5)

Turn square stone to face the outside of the fixture and lower it until it seats itself in the ring. (Diagram 6) **NOTE: FLAT SIDE FACES FRONT!**

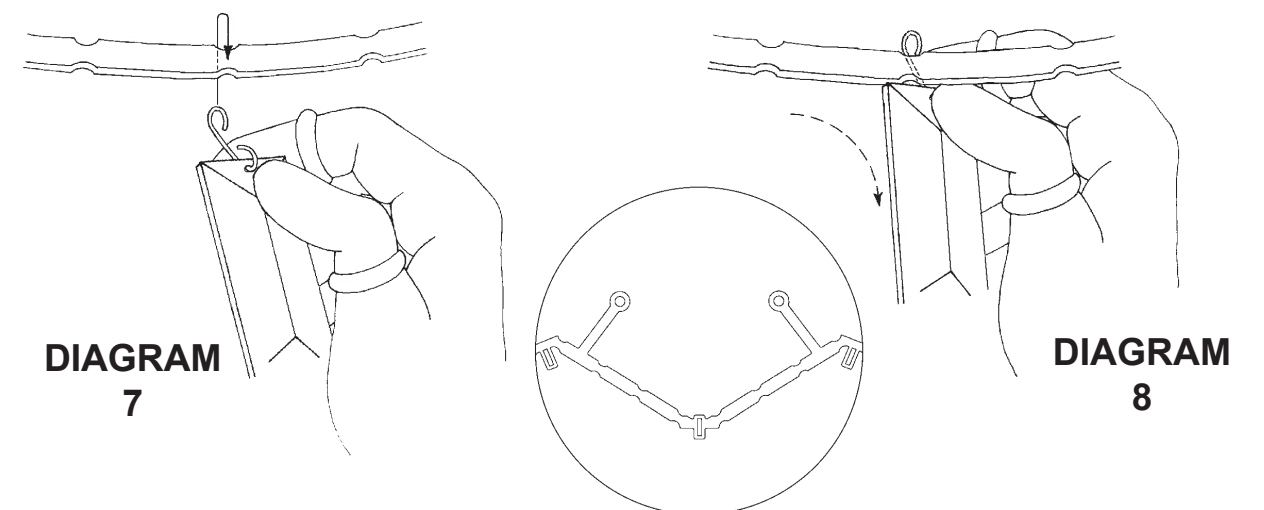

Installation of Crystals "D"

Hook Crystal "D" into the curve of the "scalloped" ring. Hold hook with index finger and thumb. Slide hook from behind scalloped ring. (Diagram 7)

Insert opening of hook onto curve of the ring and slide forward. (Diagram 8)

Allow Crystals "D" to hang in vertical position and to hang freely.
NOTE: FLAT SIDE FACES FRONT!

DIAGRAM 1

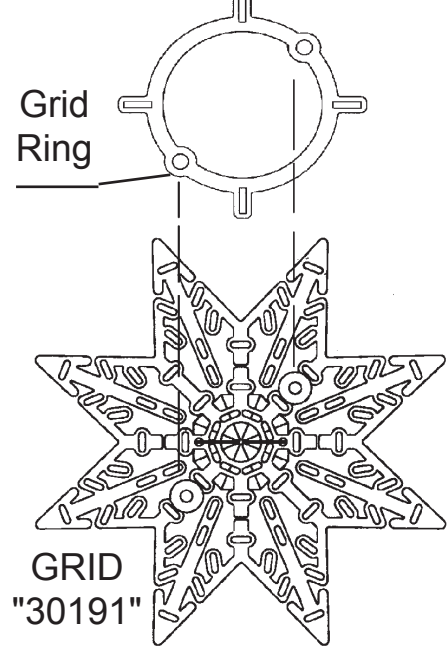

Installation of Grid "30191": Attach (1) Grid "30191" (with finial attached) with two thumb nuts (already screwed onto grid) to 7 ring. Diagram 1. (See page 5 for location on frame)

Installation of Grid "30192": Attach (8) Grids "30192" with two thumb nuts per grid (already screwed onto grid) to 6 ring. Diagram 2. (See page 5 for location on frame)

Installation of Grid "30193": Attach (8) Grids "30193" with two thumb nuts per grid (already screwed onto grid) to 5 ring. Diagram 3. (See page 5 for location on frame)

DIAGRAM 2

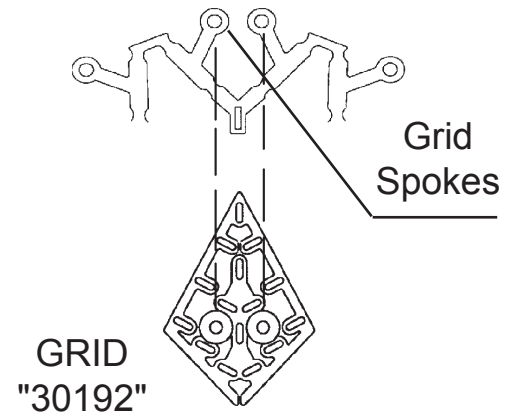

Installation of Grid "30198": Attach (8) Grids "30198" with two thumb nuts per grid (already screwed onto grid) to 4 ring. Diagram 4. (See page 5 for location on frame)

DIAGRAM 3

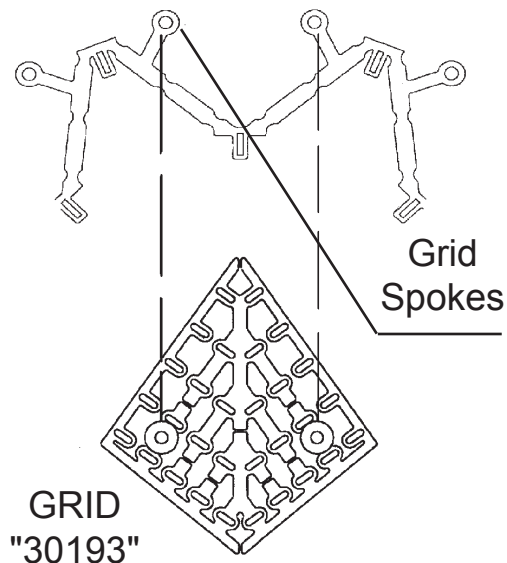
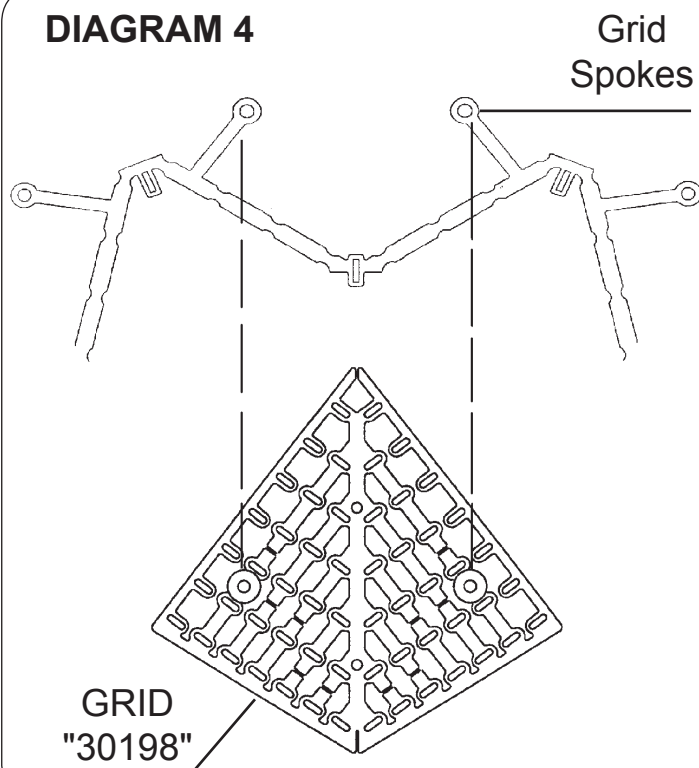
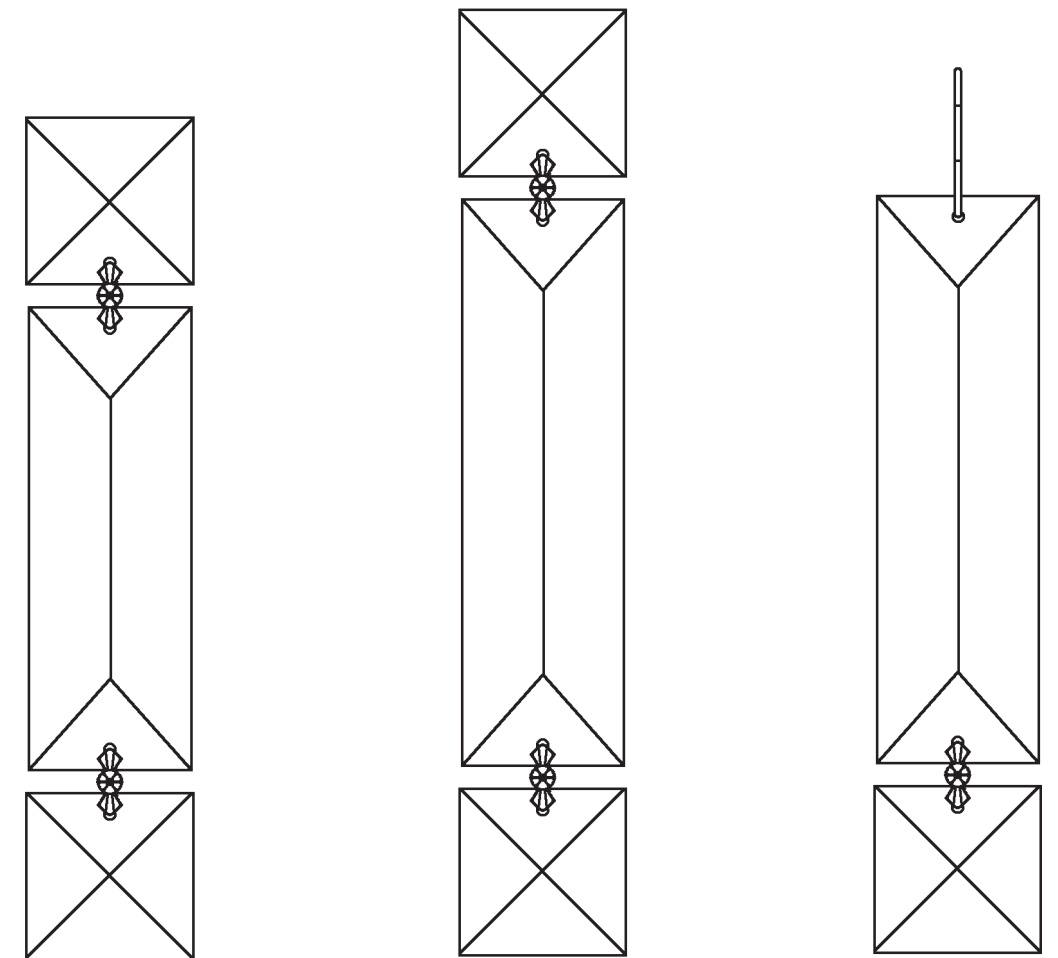

DIAGRAM 4



TRIM ID SHEET FOR ORDERING SPARE PARTS. PLEASE SAVE FOR CLEANING FIXTURE!



**A = N160 (Gold)
N160S (Silver)**

**C = N162 (Gold)
N162S (Silver)**

**D = N163 (Gold)
N163S (Silver)**

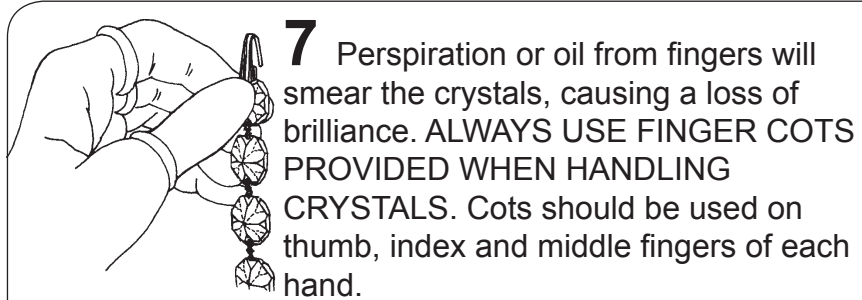

7 Perspiration or oil from fingers will smear the crystals, causing a loss of brilliance. ALWAYS USE FINGER COTS PROVIDED WHEN HANDLING CRYSTALS. Cots should be used on thumb, index and middle fingers of each hand.

**IMPORTANT:
FOLLOW ALL STEPS IN SEQUENCE**

8 TEST POWER TO INSURE PROPER WIRING BEFORE HANGING TRIM ON FIXTURE. MAKE SURE ALL BULBS ARE IN PLACE.

9 Hook Chains "A" into the slots on ring 1, see diagrams 5 & 6 on page 7 for detailed instructions. NOTE: FLAT SIDE FACES FRONT!

10 Hook Chains "A" into the slots on ring 2, see diagrams 5 & 6 on page 7 for detailed instructions. NOTE: FLAT SIDE FACES FRONT!

11 Attach (1) Grid "30191" per instructions on page 6, see diagram 1 for detailed instructions. Hook Chains "D" into scallopes on ring 6, see diagrams 7 & 8 on page 7 for detailed instructions. NOTE: FLAT SIDE FACES FRONT!

12 Attach (8) Grids "30192" per instructions on page 6, see diagram 2 for detailed instructions. Hook Chains "D" into scallopes on ring 5, see diagrams 7 & 8 on page 7 for detailed instructions. NOTE: FLAT SIDE FACES FRONT!

13 Attach (8) Grids "30193" per instructions on page 6, see diagram 3 for detailed instructions. Hook Chains "D" into scallopes on ring 4, see diagrams 7 & 8 on page 7 for detailed instructions. NOTE: FLAT SIDE FACES FRONT!

14 Attach (8) Grid "30198" per instructions on page 6, see diagram 4 for detailed instructions. Hook Chains "C" into the slots on ring 3, see diagrams 5 & 6 on page 7 for detailed instructions. NOTE: FLAT SIDE FACES FRONT!

