

# SCHONBEK®

## CHANDELIER 2472- \_\_\_\_ TRIM DIAGRAM

(Finish Option)

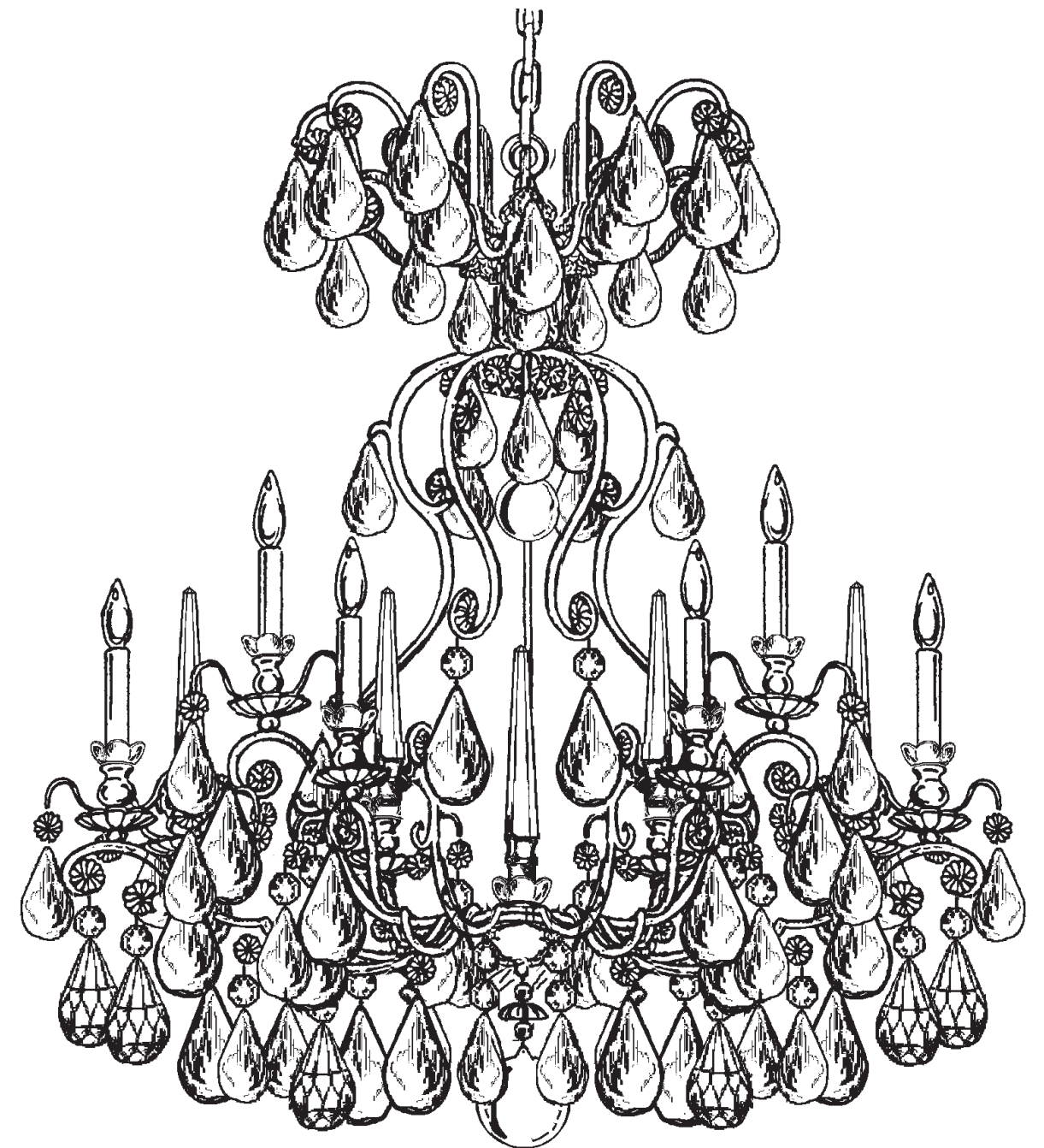

**T**HIS DESIGN IS THE PROPRIETARY TRADE DRESS/TRADEMARK OF SWAROVSKI LIGHTING, LTD.

12 Lights  
Diameter: 33"  
Body Length: 38"  
Hanging Weight: 56 lbs.

# SCHONBEK®

**Follow steps in exact order  
Save this trim diagram for future reference**

**1**

### IMPORTANT

**Person who opens carton should record the following information for future service.**

CODE # \_\_\_\_\_ Four-digit number on outside of carton.  
PACKER # \_\_\_\_\_ See crystal package label.  
ORDER # \_\_\_\_\_ See crystal package label.

**Instructions for electrician**  
**STEPS 2 - 21**

**WARNING:**

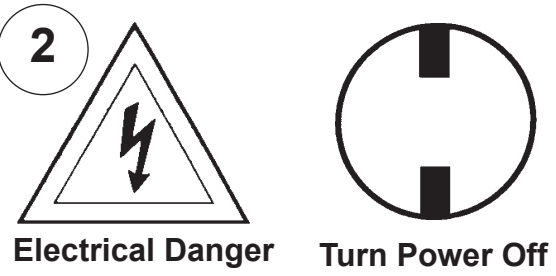

All electrical components must be installed by a licensed electrician in accordance with the National Electric Code and the appropriate local electrical codes.

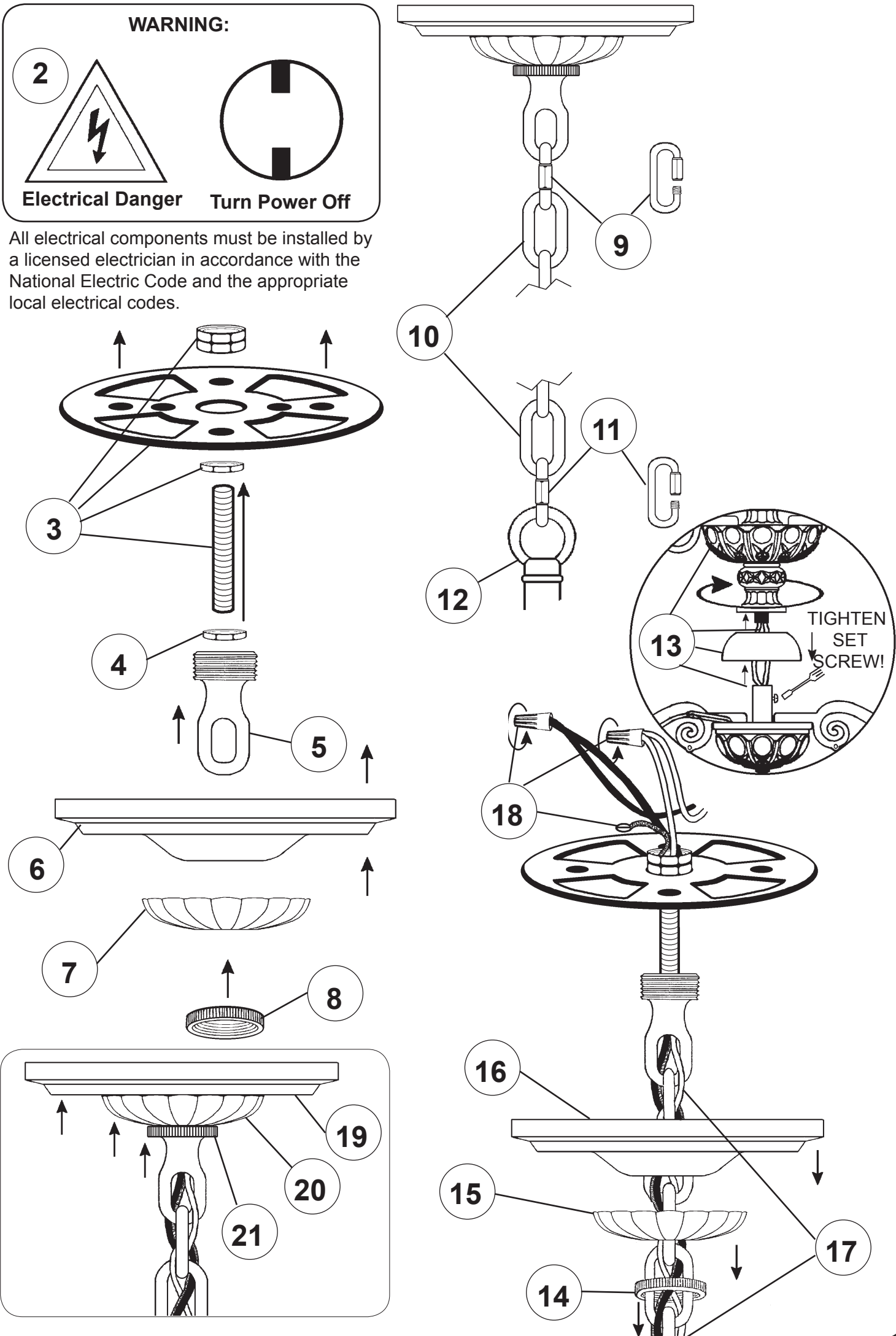

**CRYSTAL ID SHEET**

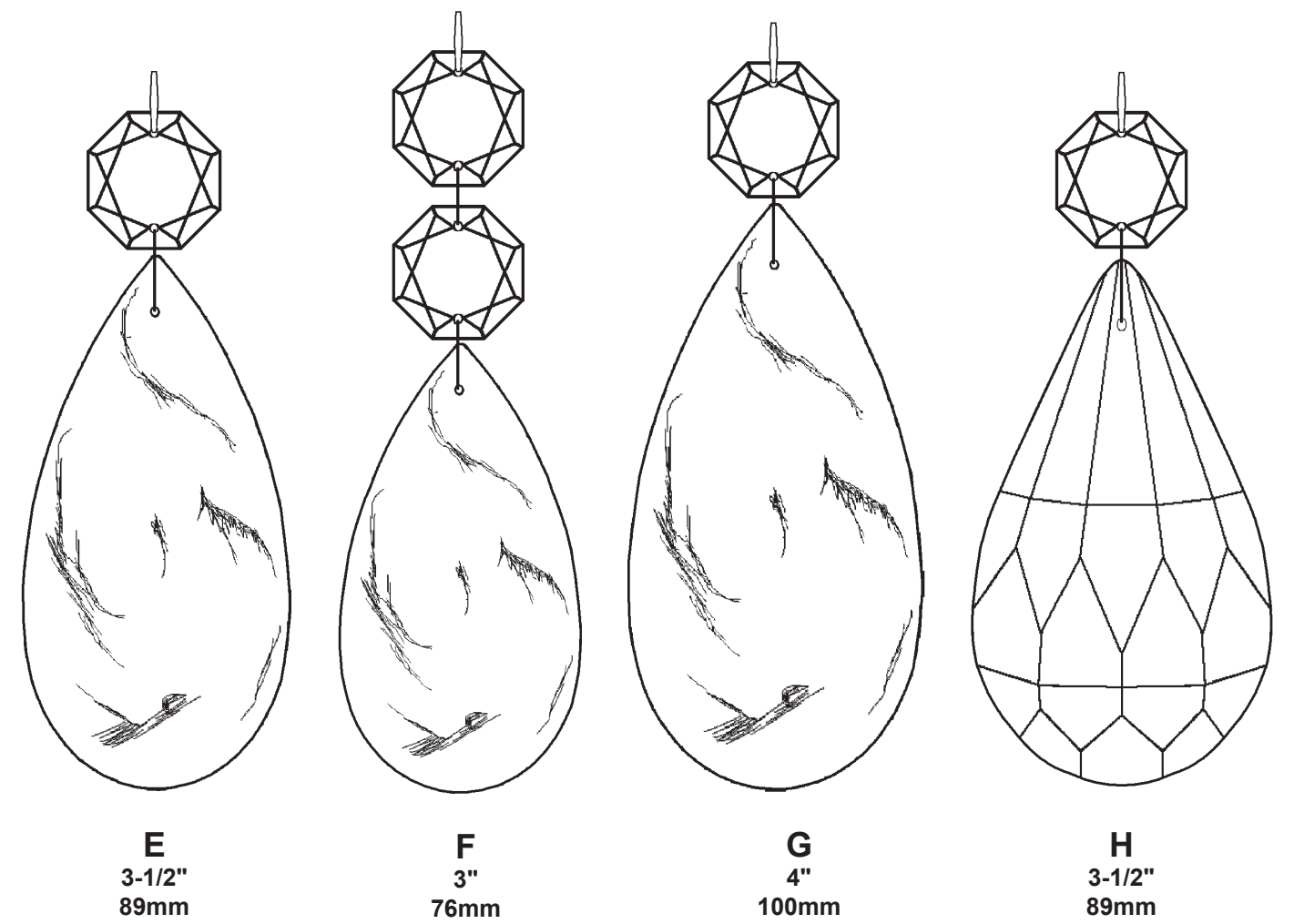
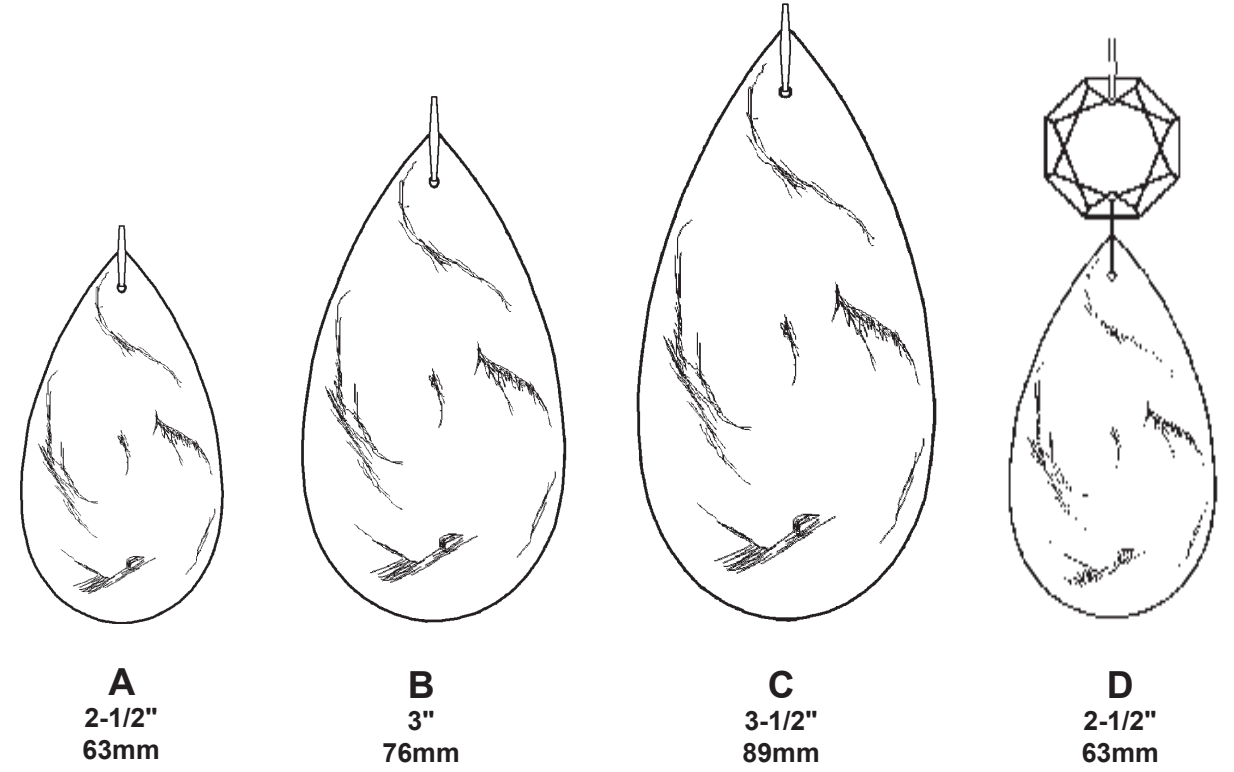

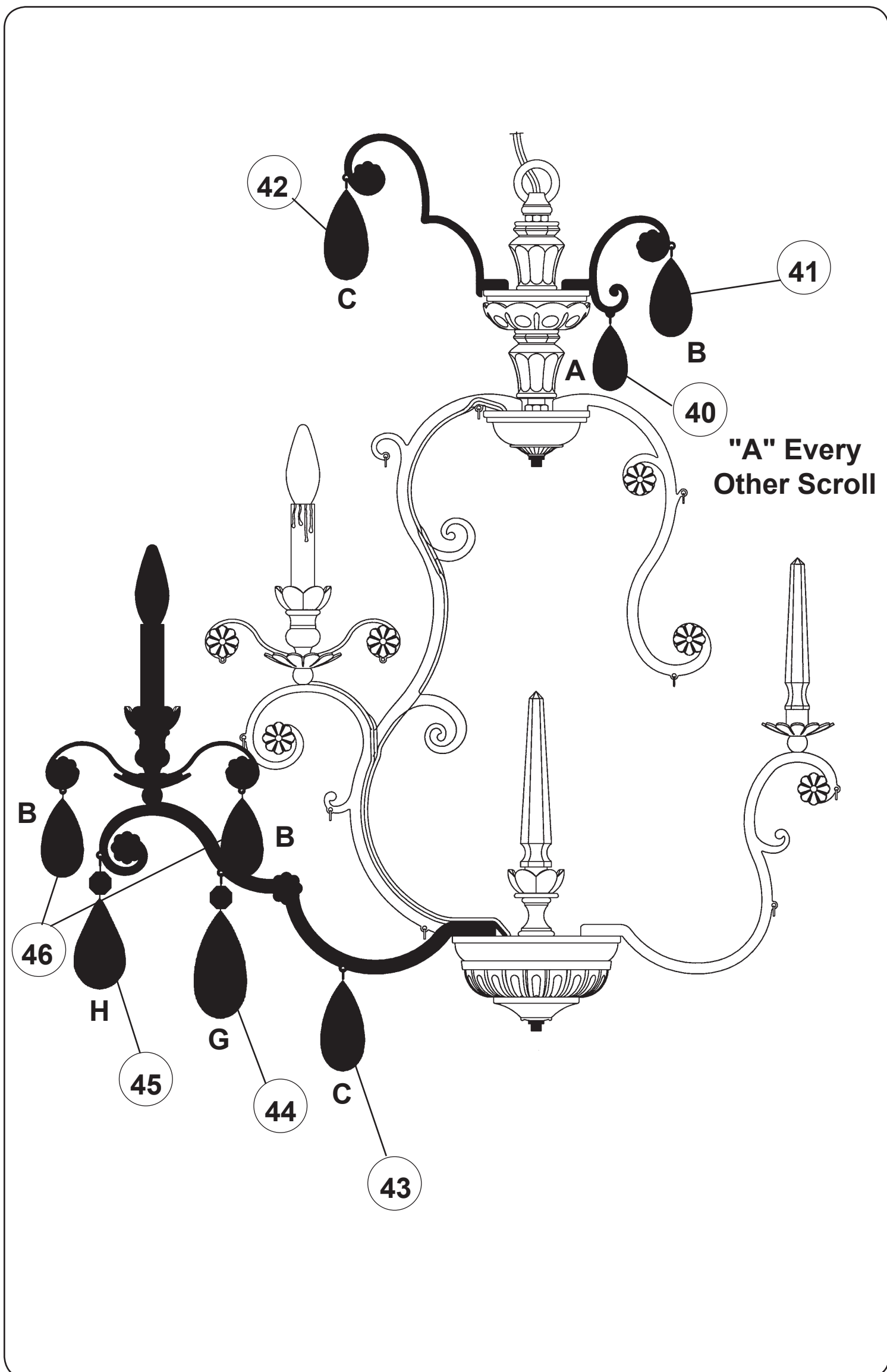

For easy removal of crystal from bubble pack, please cut along pouches on the inside of the seam. Gently remove crystal from the side of the pouch.

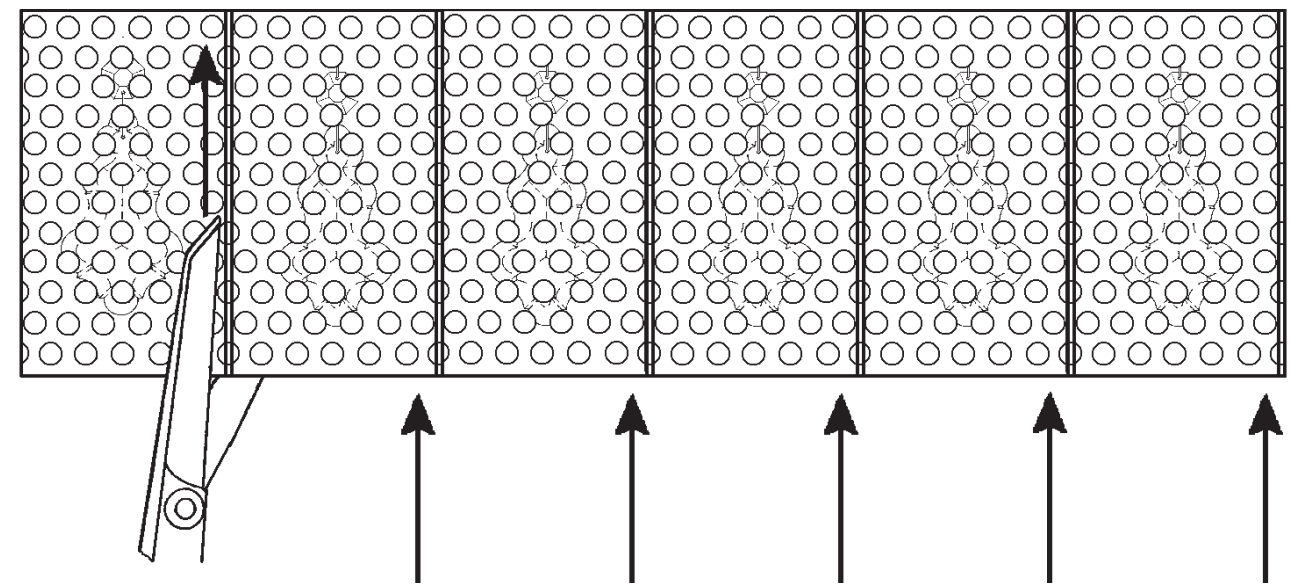

**NOTE:** Work on one crystal set at a time. Follow the black line from top to bottom according to the numbered steps on the trim diagram.

# Instructions for crystal trimming

## STEPS 22 - 46

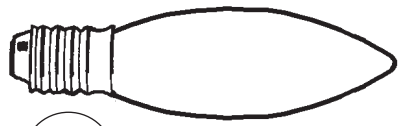

**22**

You will need 12 - B10  
25 Watts Recommended  
60 Watts Max

**27**

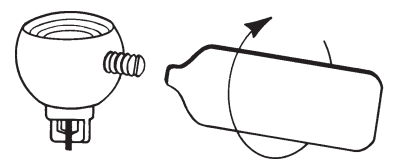

Tighten With  
Tool Provided.

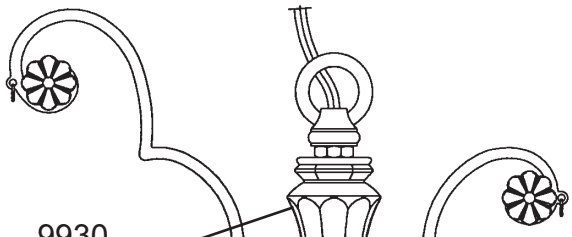

9930

9763

9930

**25**

90072/7/1



**24**

90072/7/1



**31**

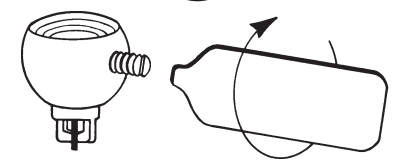

Tighten With  
Tool Provided.

**SPARE PARTS KIT  
PROVIDED.**

