



ASSEMBLY INSTRUCTIONS

ITEM NO.: 8-5779-3

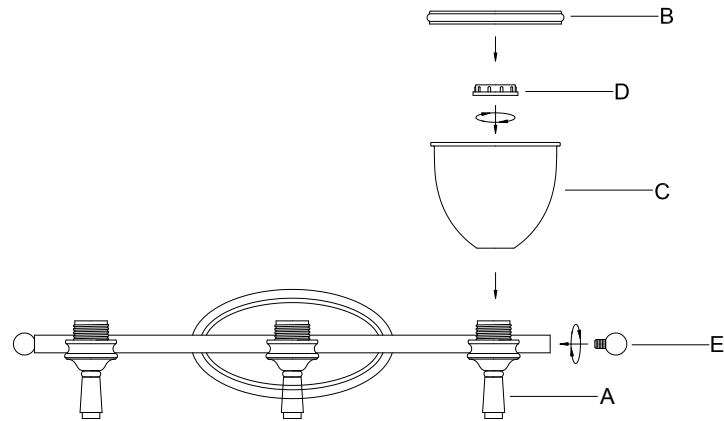

Fig.1

C → A → D → B → E

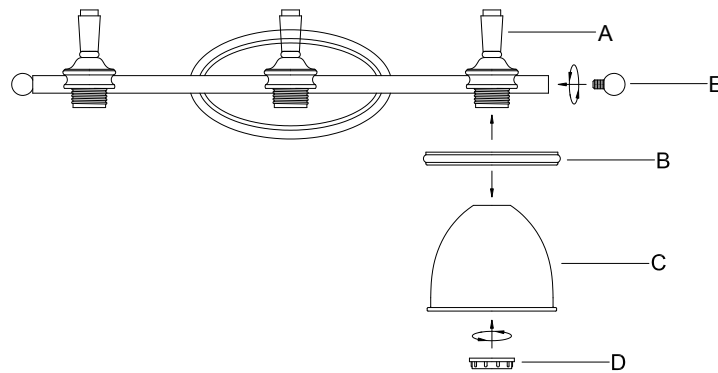

Fig.2

B → C → A → D → E

INITIAL INSTRUCTIONS:

1. Carefully unpack and identify all parts referring to illustration for parts identification.
2. Turn the power to the installation point OFF.

Fig.1 ASSEMBLY INSTRUCTIONS:

3. Carefully place the glass (C) over the socket of the fixture body (A) and secure with socket ring (D).
4. Place the decorative ring (B) over the top of the glass (C) properly.

Fig.2 ASSEMBLY INSTRUCTIONS:

3. Place the decorative ring (B) over the bottom of the glass (C) properly.
4. Carefully place the glass (C) over the socket of the fixture body (A) and secure with socket ring (D).

FINAL INSTRUCTIONS:

5. Thread the finial (E) over the tube of fixture body (A) as shown in drawing.
6. Referring to the installation instruction with the product for the wiring and installation.
7. Install a proper bulb (not provided) to the each socket referring to the marking and/or labels on the fixture for maximum wattage.
8. Restore the power to the installation point ON.
9. Assembly is completely. Retain this sheet for future reference.