

SAMSUNG

Product Guide

8751 Series Flex Duo™ Front Control Slide-In Dual Fuel Range

NY63T8751SS

NY63T8751SG

Available in: Fingerprint Resistant Stainless Steel
and Fingerprint Resistant Black Stainless Steel



Table of Contents

NY63T8751 - 6.3 cu. ft. Flex Duo™ Front Control Slide-in Dual Fuel Range with Smart Dial, Air Fry & Wi-Fi

Product Overview

Product Overview 4

Carousel Image Order and Assets 5

Product Messaging

Core Messaging 7

Features and Benefits 8

Product Specs

Related Products & Accessories 15

Spec Sheet 16

User Manual 17

Feature Icons

19

Product Overview

**6.3 cu. ft. Flex Duo™ Front Control Slide-in Dual Fuel Range
with Smart Dial, Air Fry & Wi-Fi**

Product Overview

Product Title

6.3 cu. ft. Flex Duo™ Front Control Slide-in Dual Fuel Range with Smart Dial, Air Fry & Wi-Fi

Product Description

The new Samsung Front Control Slide-in Dual Fuel Range with Smart Dial and Air Fry is fully Wi-Fi connected and voice enabled, giving you the tools you need to simplify the cooking experience in the kitchen.

Available Colors



**Fingerprint Resistant
Stainless Steel**
NY63T8751SS



**Fingerprint Resistant
Black Stainless Steel**
NY63T8751SG



Carousel Image Order

Easy Ads links

Fingerprint Resistant Stainless Steel: <http://www.samsungeasyads.com/mm/nicePath/easyads?nav=pr659030478>
Fingerprint Resistant Black Stainless Steel: <http://www.samsungeasyads.com/mm/nicePath/easyads?nav=pr659040551>

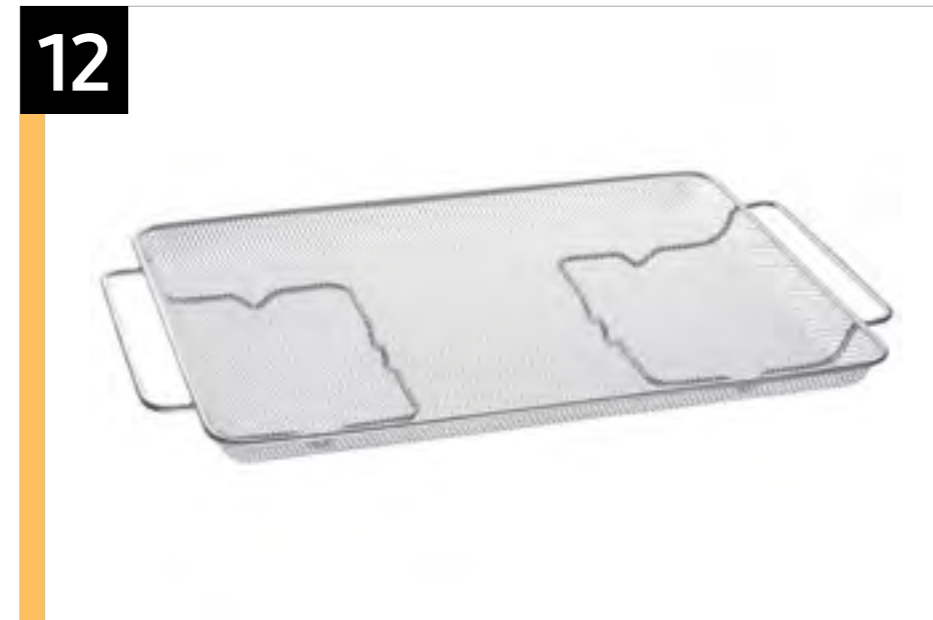

Product Messaging

**6.3 cu. ft. Flex Duo™ Front Control Slide-in Dual Fuel Range
with Smart Dial, Air Fry & Wi-Fi**

Core Messaging

| Priority | Feature | Feature Headline | Short Copy | Long Copy | |
|--------------------|---------|-------------------------------------|---|---|--|
| Signature | 1 | Smart Dial | Learns How You Like to Cook | The new Smart Dial simplifies oven settings in a single dial and learns cooking preferences. | The new Smart Dial simplifies oven settings in a single dial and intuitively learns based on your cooking preferences. |
| | 2 | Air Fry | Air Fry - Healthier* Cooking with a Crunch <small>*As compared to deep frying.</small> | A healthier* way to prepare your favorite fried foods right in your oven, with little to no oil. <small>*As compared to deep frying.</small> | Cooking just got healthier* with new Air Fry mode. Using little to no oil, you can quickly prepare your favorite fried foods right in your oven. Air Fry tray included. <small>*As compared to deep frying.</small> |
| | 3 | Flex Duo™ | Two Ovens or One, You Choose | Use the full oven or split it into two separate smaller ovens to suit your needs. | The Flex Duo™ range is for the ultimate multi-tasker who wants to be efficient in the kitchen. Use the full oven, or split it into two separate smaller ovens to suit your needs. |
| Secondary Features | 4 | Dual Fuel | The Best of Both Worlds | Combination gas cooktop and electric oven provides the best of both cooking methods for precision and efficiency. | Our combination gas cooktop and electric oven provides the best of both cooking methods for precision and efficiency. The gas cooktop offers powerful, even and precise heating. The convection electric oven heats evenly for superior baking, warming and broiling. |
| | 5 | Convection | Save Time with Convection | Cooks food fast and more evenly. | Powerful convection saves you time by cooking food fast and more evenly. Perfect for baking and roasting. |
| | 6 | Illuminated Knobs | Know It's On | Illuminated knobs let you know when your cooktop is on or off. | Blue illuminated knobs let you know when your cooktop is on or off. |
| | 7 | Fingerprint Resistant Finish | All Shine | Fingerprint resistant, beautiful finish. | Fingerprint resistant, for an everyday beautiful finish. |
| | 8 | Dual Ring Brass Power Burner | Unbelievable Power | A range that has the most powerful burner in the industry* – quickly boils water and sears meat with this 23K BTU Dual Ring Brass Power Burner or turn down to a true simmer. <small>*Based upon BTU, when compared to 30" gas ranges.</small> | Make meals in a snap, with a range that has the most powerful burner in the industry*. Rapidly go to high heat for quickly boiling water and searing meat with this 23K BTU Dual Ring Brass Power Burner or turn down to a true simmer – ideal for melting chocolate or making sauces. <small>*Based upon BTU, when compared to 30" gas ranges.</small> |
| | 9 | Flexible Cooktop | Flexible in Every Way | The 5-burner cooktop with continuous edge-to-edge grates provides more usable cooktop space. | The 5-burner cooktop with continuous cast iron edge-to-edge grates allows you to easily slide your pots and pans across more usable cooktop space and adds a more premium look to your kitchen. |
| | 10 | Reversible Cast-Iron Griddle | Griddle or Grill? You Choose | Cook breakfast food, burgers or grilled sandwiches on the reversible cast iron griddle. | Cook a variety of breakfast food, burgers or grilled sandwiches on the reversible cast iron griddle. |
| | 11 | Large Oven Capacity | Cook Enough for the Whole Crew | This large 6.3 cu. ft. oven fits multiple meals at one time. | This large 6.3 cu. ft. oven fits multiple meals at one time, or it can easily accommodate big casserole dishes or roasting pans. |

Core Messaging (continued)

| Priority | Feature | Feature Headline | Short Copy | Long Copy | |
|--------------------------|---------|----------------------------|-----------------------------------|--|--|
| Secondary Features cont. | 12 | Wi-Fi Connectivity | Cook Smart, Save Time | Preheat, monitor, and adjust cook time and temperature on your oven and monitor your cooktop, right from your smartphone through the SmartThings™ App.* <small>*Available on Android and iOS devices. A Wi-Fi connection and a Samsung account are required.</small> | Preheat, monitor, and adjust cook time and temperature on your oven and monitor your cooktop, right from your smartphone through the SmartThings™ App.* <small>*Available on Android and iOS devices. A Wi-Fi connection and a Samsung account are required.</small> |
| | 12 | Voice-Enabled | “Preheat the Oven to 350° Please” | Control your oven by voice by using your favorite voice assistant, whether it’s Bixby, Alexa or Google.* <small>*A Wi-Fi connection and a Samsung account are required. Bixby is Samsung’s brand of artificial intelligence (AI) / Internet of Things (IoT) voice assistant. Voice commands are available on Android and iOS devices.</small> | Control your oven by voice when you’re busy doing other things by using your favorite virtual assistant, whether it’s Bixby, Alexa or Google.* <small>*A Wi-Fi connection and a Samsung account are required. Bixby is Samsung’s brand of artificial intelligence (AI) / Internet of Things (IoT) voice assistant. Voice commands are available on Android and iOS devices.</small> |
| | 13 | Self & Steam Clean | Does The Hard Work For You | Get help from your oven with Self & Steam Clean. | Get help from your oven with Self & Steam Clean. The self cleaning system deep cleans by heating to a high temperature to burn off grease and food residue. Steam clean in 20 minutes for easier cleaning jobs. |
| | 14 | Ready2Fit™ Guarantee | – | – | If your Samsung Front Control Slide-In Range doesn’t fit your 30" Freestanding Range cutout, enjoy \$100* on us to cover any countertop modification costs. <small>*Visit samsungpromotions.com/SlideInReady2Fit for details.</small> |
| | 15 | Built-in Temperature Probe | Know When the Roast Is Ready | Check the internal temperature of meats on your oven or smartphone.* <small>*Available on Android and iOS devices. A Wi-Fi connection and a Samsung account are required.</small> | Know the internal temperature of meats with a built-in temperature probe you can check on your oven or with your smartphone.* <small>*Available on Android and iOS devices. A Wi-Fi connection and a Samsung account are required.</small> |
| | 16 | Gliding Rack | Glide with Ease | Use the gliding rack to easily & safely take food out of the oven. | Use the gliding rack to easily & safely take food out of the oven. Simply hold the handle of the rack to slide it in and out. |
| | 17 | Wok Ring | A Perfect Fit for Stir Frying | Easily accommodate a round-bottomed wok on the custom wok ring. | Easily accommodate a round-bottomed wok on the custom wok ring. Its design fits snug around the burner so that heat is quickly and evenly distributed. The custom wok ring is included with purchase. |

Features and Benefits



Smart Dial

The new Smart Dial simplifies oven settings in a single dial and intuitively learns based on your cooking preferences.

Video and still asset available.

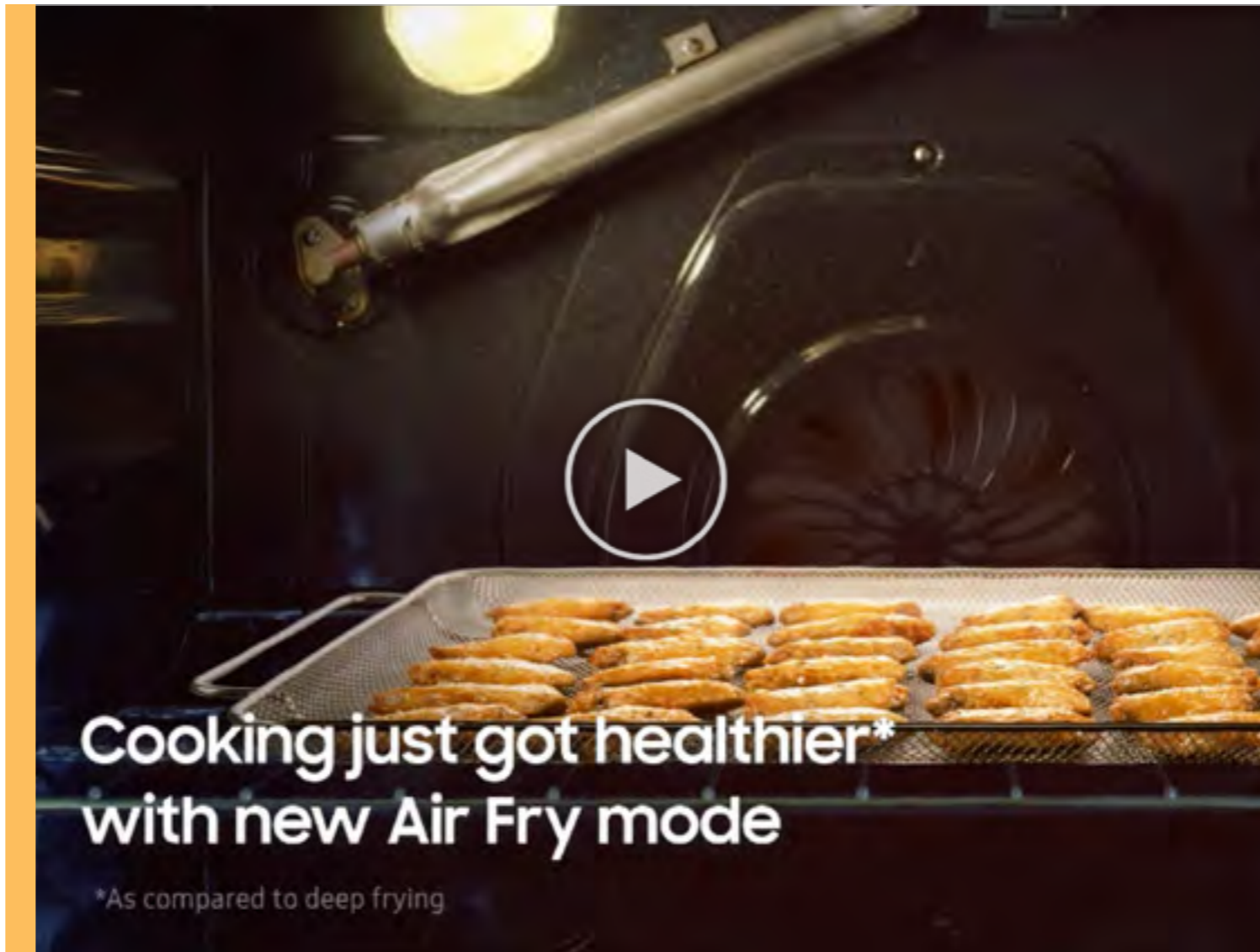

Air Fry

Cooking just got healthier* with new Air Fry mode. Using little to no oil, you can quickly prepare your favorite fried foods right in your oven. Air Fry tray included.

*As compared to deep frying.

Video and still asset available.



Flex Duo™

The Flex Duo™ range is for the ultimate multi-tasker who wants to be efficient in the kitchen. Use the full oven, or split it into two separate smaller ovens to suit your needs.

Easy Ads links

Fingerprint Resistant Stainless Steel: <http://www.samsungeasyads.com/mm/nicePath/easyads?nav=pr659121364>

Features and Benefits (continued)



Dual Fuel

Our combination gas cooktop and electric oven provides the best of both cooking methods for precision and efficiency. The gas cooktop offers powerful, even and precise heating. The convection electric oven heats evenly for superior baking, warming and broiling.



Convection

Powerful convection saves you time by cooking food fast and more evenly. Perfect for baking and roasting.



Illuminated Knobs

Blue illuminated knobs let you know when your cooktop is on or off.

Easy Ads links

Fingerprint Resistant Stainless Steel: <http://www.samsungeasyads.com/mm/nicePath/easyads?nav=pr659121364>

Features and Benefits (continued)

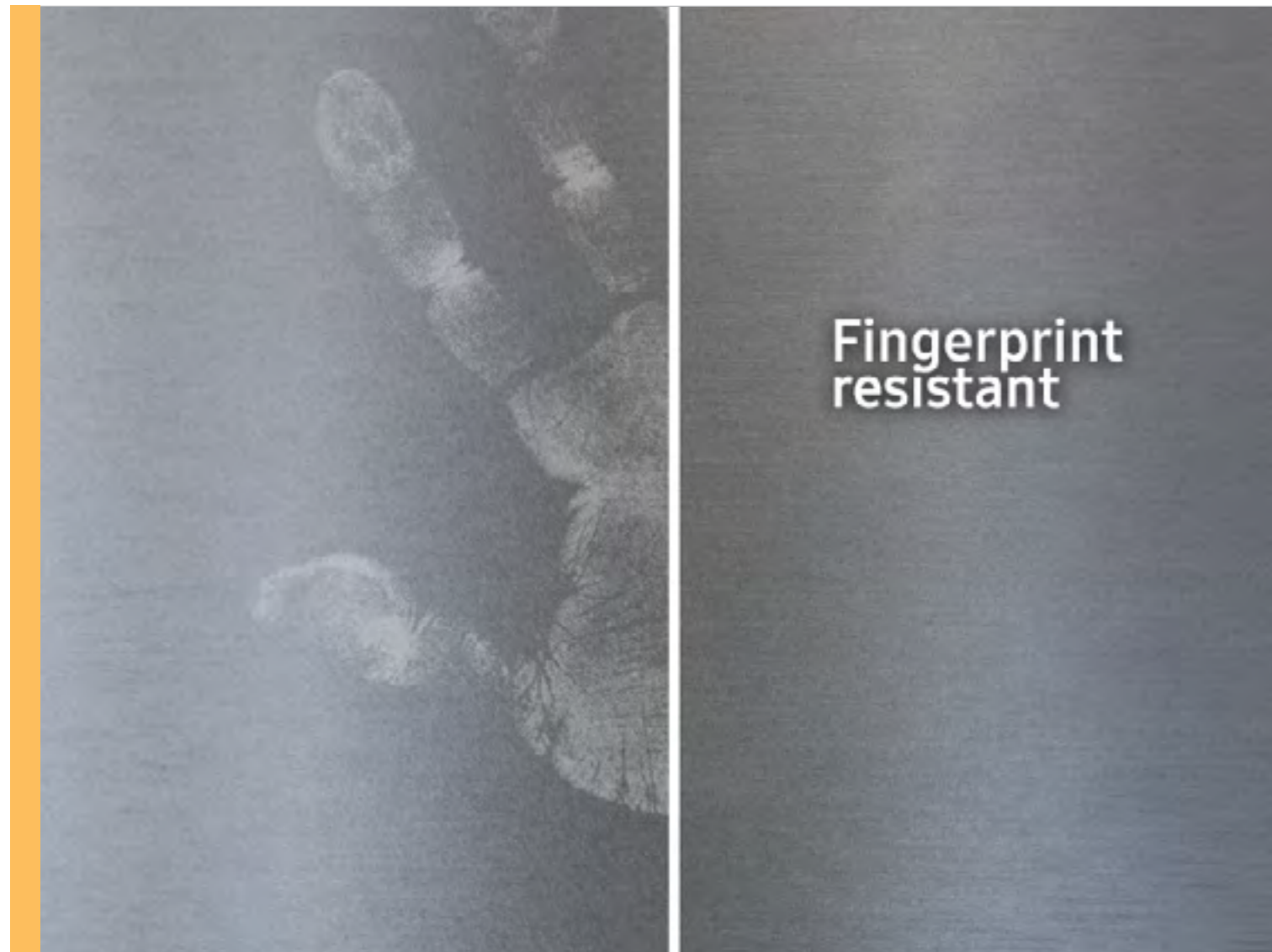

Fingerprint Resistant Finish

Fingerprint resistant, for an everyday beautiful finish.

Ensure asset used is accurate to the correct model finish color.



Dual Ring Brass Power Burner

Make meals in a snap, with a range that has the most powerful burner in the industry*. Rapidly go to high heat for quickly boiling water and searing meat with this 23K BTU Dual Ring Brass Power Burner or turn down to a true simmer – ideal for melting chocolate or making sauces.

*Based upon BTU, when compared to 30" gas ranges.

Video and still asset available.



Flexible Cooktop

The 5-burner cooktop with continuous cast iron edge-to-edge grates allows you to easily slide your pots and pans across more usable cooktop space and adds a more premium look to your kitchen.

Easy Ads links

Fingerprint Resistant Stainless Steel: <http://www.samsungeasyads.com/mm/nicePath/easyads?nav=pr659121364>

Features and Benefits (continued)



Reversible Cast-Iron Griddle

Cook a variety of breakfast food, burgers or grilled sandwiches on the reversible cast iron griddle.



Large Oven Capacity

This large 6.3 cu. ft. oven fits multiple meals at one time, or it can easily accommodate big casserole dishes or roasting pans.



Wi-Fi Connectivity

Preheat, monitor, and adjust cook time and temperature on your oven and monitor your cooktop, right from your smartphone through the SmartThings™ App.*

*Available on Android and iOS devices. A Wi-Fi connection and a Samsung account are required.

Easy Ads links

Fingerprint Resistant Stainless Steel: <http://www.samsungeasyads.com/mm/nicePath/easyads?nav=pr659121364>

Features and Benefits (continued)

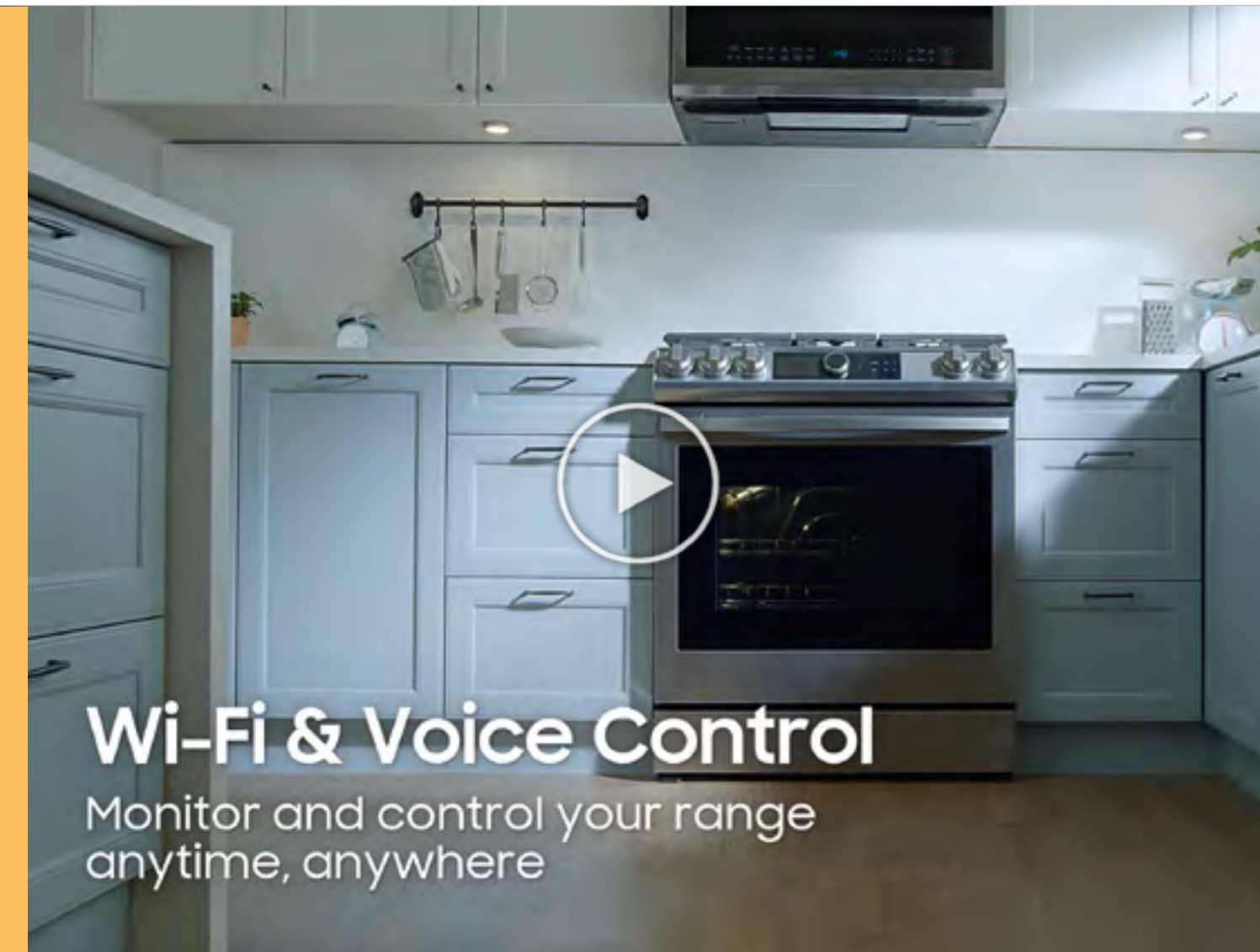

Voice-Enabled

Control your oven by voice when you're busy doing other things by using your favorite virtual assistant, whether it's Bixby, Alexa or Google.*

*A Wi-Fi connection and a Samsung account are required. Bixby is Samsung's brand of artificial intelligence (AI) / Internet of Things (IoT) voice assistant. Voice commands are available on Android and iOS devices.

Video and still asset available.



Self & Steam Clean

Get help from your oven with Self & Steam Clean. The self cleaning system deep cleans by heating to a high temperature to burn off grease and food residue. Steam clean in 20 minutes for easier cleaning jobs.

Video and still asset available.



Ready2Fit™ Guarantee

If your Samsung Front Control Slide-In Range doesn't fit your 30" Freestanding Range cutout, enjoy \$100* on us to cover any countertop modification costs.

*Visit samsungpromotions.com/SlideInReady2Fit for details.

Still asset available, video asset to come.

Easy Ads links

Fingerprint Resistant Stainless Steel: <http://www.samsungeasyads.com/mm/nicePath/easyads?nav=pr659121364>

Features and Benefits (continued)

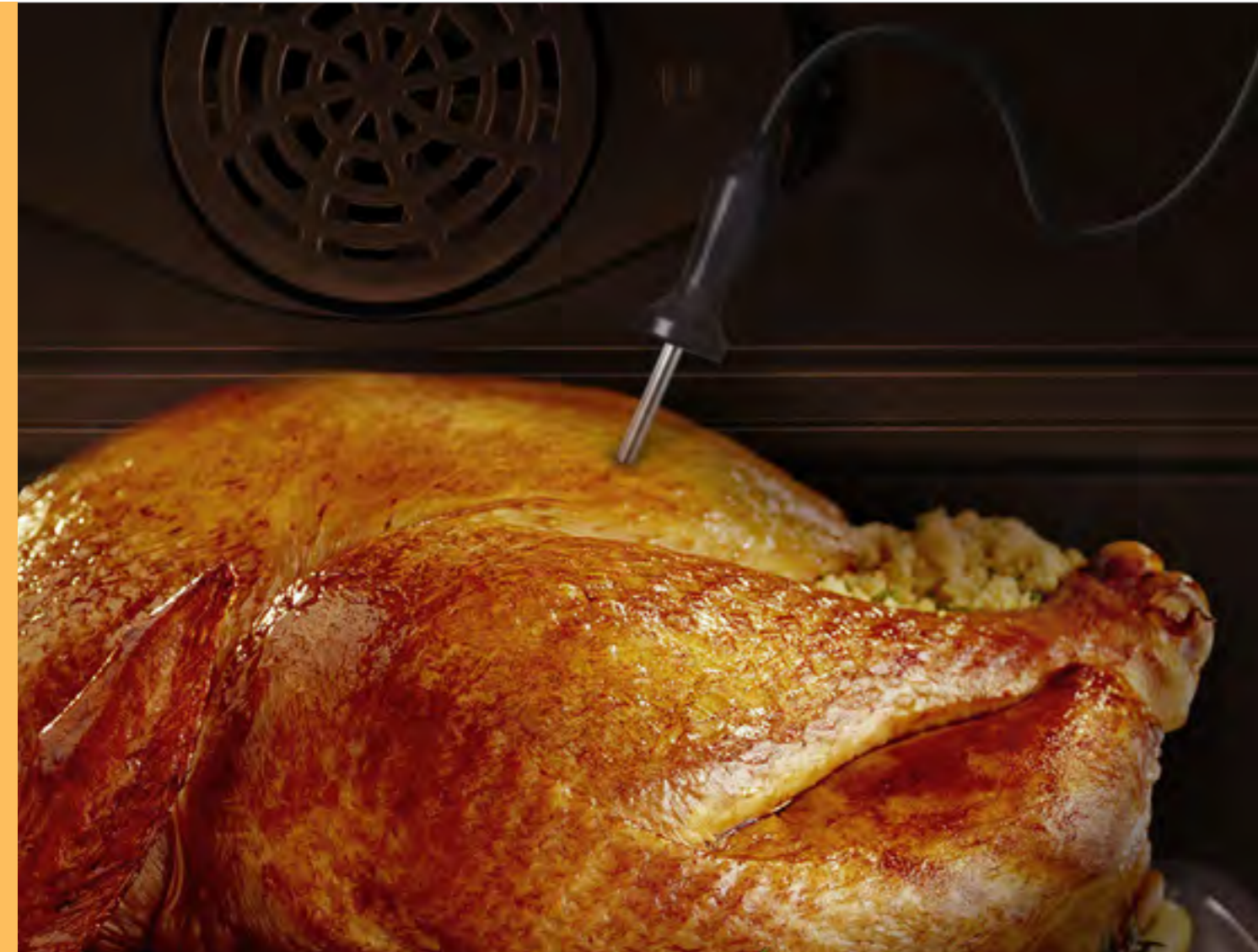

Built-In Temperature Probe

Know the internal temperature of meats with a built-in temperature probe you can check on your oven or with your smartphone.*

*Available on Android and iOS devices. A Wi-Fi connection and a Samsung account are required.



Gliding Rack

Use the gliding rack to easily & safely take food out of the oven. Simply hold the handle of the rack to slide it in and out.



Wok Ring

Easily accommodate a round-bottomed wok on the custom wok ring. Its design fits snug around the burner so that heat is quickly and evenly distributed. The custom wok ring is included with purchase.

Easy Ads links

Fingerprint Resistant Stainless Steel: <http://www.samsungeasyads.com/mm/nicePath/easyads?nav=pr659121364>

Product Specs

**6.3 cu. ft. Flex Duo™ Front Control Slide-in Dual Fuel Range
with Smart Dial, Air Fry & Wi-Fi**

Related Products

| SKU | Type | Color(s) |
|----------------|--------------------------|----------------|
| NY63T8751SS/AA | Range Hood | NK30K7000WS/A2 |
| | Over-The-Range Microwave | ME21M706BAS/AA |
| | Dishwasher | DW80R9950US/AA |
| | Refrigerator | RF22R7551SR/AA |
| NY63T8751SG/AA | Range Hood | NK30K7000WG/A2 |
| | Over-The-Range Microwave | ME21M706BAG/AA |
| | Dishwasher | DW80R9950UG/AA |
| | Refrigerator | RF22R7551SG/AA |

Accessories

| SKU | Description | Color(s) |
|---------------|--|--|
| NX-AB900WS/AA | 9" backguard for 30" slide-in range | Fingerprint Resistant Stainless Steel |
| NX-AB400WS/AA | 4" backguard for 30" slide-in range | |
| NX-AF900WS/AA | Trim kit for 30" slide-in range, 5 piece | |
| NX-AB900WG/AA | 9" backguard for 30" slide-in range | Fingerprint Resistant Black Stainless Steel |
| NX-AB400WG/AA | 4" backguard for 30" slide-in range | |
| NX-AF900WG/AA | Trim kit for 30" slide-in range, 5 piece | |

Spec Sheet

Easy Ads link

<https://www.samsungeasyads.com/mm/nicePath/easyads?nav=pr658983412>

NY63T875ISS SAMSUNG

Samsung Flex Duo™ Front Control Slide-in Dual Fuel Range with Smart Dial & Air Fry

6.3 cu. ft. Capacity



Signature Features

Smart Dial

- The new Smart Dial simplifies oven settings in a single dial and intuitively learns based on your cooking preferences.

Air Fry

- Cooking just got healthier* with new Air Fry mode. Using little to no oil, you can quickly prepare your favorite fried foods right in your oven. Air Fry tray included.

*As compared to deep frying.

Flex Duo™

- The Flex Duo™ range is for the ultimate multi-tasker who wants to be efficient in the kitchen. Use the full oven, or split it into two separate smaller ovens to suit your needs.

Available Colors

- Fingerprint Resistant Stainless Steel (shown)
- Fingerprint Resistant Black Stainless Steel



Smart Dial



Air Fry

Features

- Smart Dial
- Air Fry, Tray Included
- Flex Duo™
- Dual Fuel - Gas Cooktop, Electric Oven
- Convection
- Illuminated Knobs
- Fingerprint Resistant Finish
- Reversible Cast-Iron Griddle
- Large Oven Capacity - 6.3 cu. ft.
- Ready2Fit™ Guarantee
- Temperature Probe
- Gliding Rack
- Soft Close Door
- Wok Ring
- Storage Drawer

- Flexible Cooktop: Five Burner Cooktop
- Right Front: 23K BTU Dual Ring Brass Power Burner
- Left Front: 16K BTU
- Right Rear: 5K BTU
- Left Rear: 9.5K BTU
- Center (Oval): 10K BTU

Convenience

- Wi-Fi Connectivity
- Voice-Enabled
- Convection Auto Conversion
- Steam & Self Clean
- Hidden Bake Element
- Child Safety Lock
- Delay Start
- Auto Oven Light
- Kitchen Timer
- Sabbath Mode



Spec Sheet - front

NY63T875ISS SAMSUNG

Samsung Flex Duo™ Front Control Slide-in Dual Fuel Range with Smart Dial & Air Fry

Installing Your Range

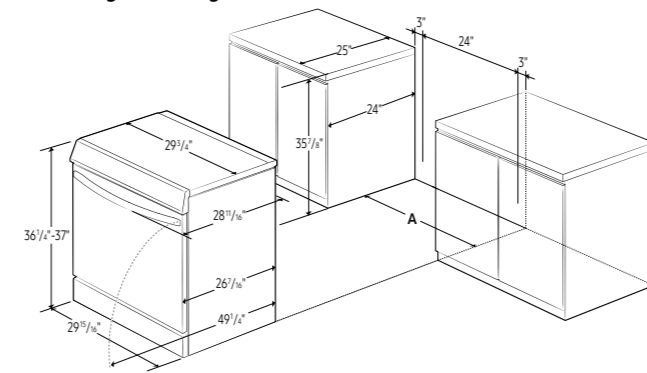

A: Cabinet opening 30"
IMPORTANT: If your cabinets are over 37" high, you must install this range on a hard, heat-resistant support that raises the surface of the range so that it is about even with the countertop.

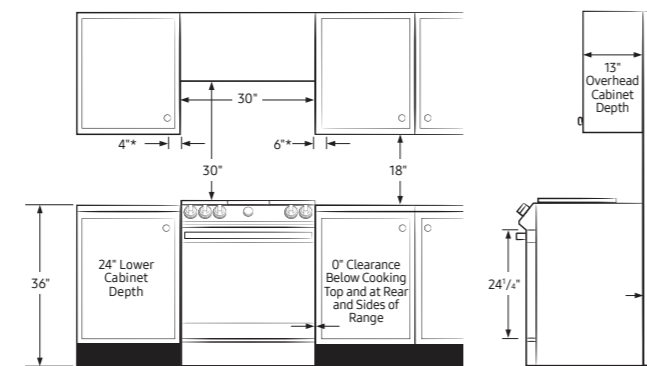

*Side clearance above cooking surface to any objects, i.e., walls.
IMPORTANT: Consult with Installation Manual for detailed instructions before installing. All ranges must be installed with the Anti-Tip device that is included.

Recommended Locations for Gas Piping and Electrical Outlets

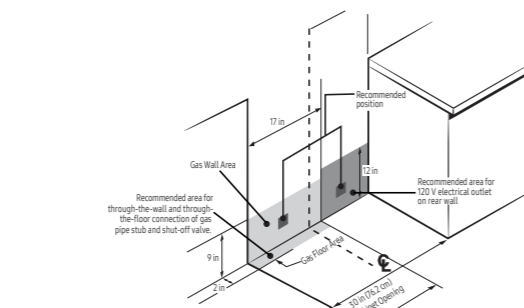

Actual color may vary. Design, specifications, and color availability are subject to change without notice. Non-metric weights and measurements are approximate.
 ©2020 Samsung Electronics America, Inc. 85 Challenger Road, Ridgefield Park, NJ 07660. Tel: 800-SAMSUNG. Samsung.com. Samsung is a registered trademark of Samsung Electronics Co. Ltd.

Power Source
240V/208V/60Hz/40A

Total Power (BTU)
63,500 BTU

Stainless Steel 5-Burner Cooktop

- Right Front: 23K BTU Dual Ring, Brass
- Left Front: 16K BTU
- Right Rear: 5K BTU
- Left Rear: 9.5K BTU
- Center (Oval): 10K BTU

Oven

- Upper Capacity: 3.4 cu. ft.
- Lower Capacity: 2.7 cu. ft.
- Convection Element/Heater
- Convection Bake
- Convection Roast
- Bake
- Variable Broil: Low/High
- Air Fry
- Bread Proof
- Dehydrate

Warranty

One (1) Year Parts and Labor

Product Dimensions & Weight (WxHxD)

Actual Oven Dimensions:
24¹³/₁₆" x 22⁷/₁₆" x 19¹/₄"

Outside Dimensions:
29¹⁵/₁₆" x 36¹/₄"-37" (Adjustable) x 28¹¹/₁₆"

Weight: 236 lbs

Shipping Dimensions & Weight (WxHxD)

Dimensions:
33¹/₁₆" x 41¹/₄" x 30⁵/₁₆"

Weight: 262 lbs

Color Fingerprint Resistant Stainless Steel NY63T8751SS 887276409177

Fingerprint Resistant Black Stainless Steel NY63T8751SG 887276409160

Color

Fingerprint Resistant Stainless Steel NY63T8751SS 887276409177

Fingerprint Resistant Black Stainless Steel NY63T8751SG 887276409160

Fingerprint Resistant Black Stainless Steel NY63T8751SG 887276409160



Spec Sheet - back

User Manual

Easy Ads link

<https://www.samsungeasyads.com/mm/nicePath/easyads?nav=pr658983412>

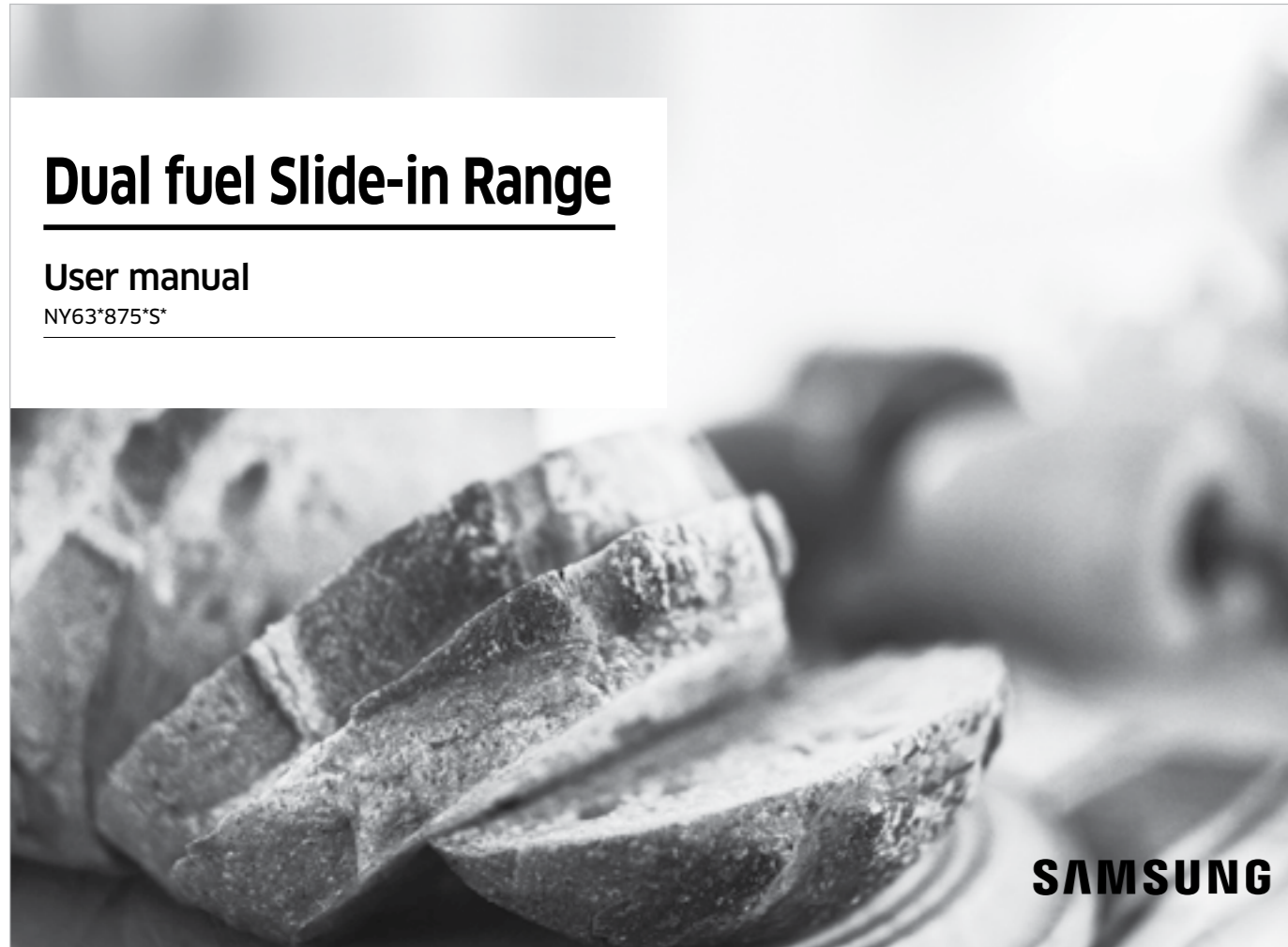

User Manual

Feature Icons

**6.3 cu. ft. Flex Duo™ Front Control Slide-in Dual Fuel Range
with Smart Dial, Air Fry & Wi-Fi**

Feature Icons

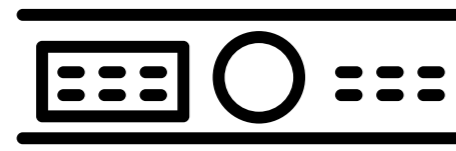

Smart Dial



Air Fry

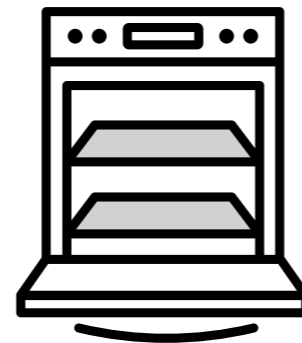

Flex Duo™

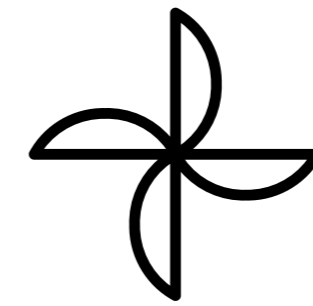

Convection



Illuminated Knobs



Fingerprint Resistant Finish



Dual Valve Brass Burner

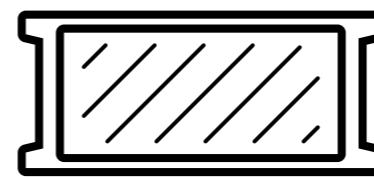

Reversible Cast Iron Griddle

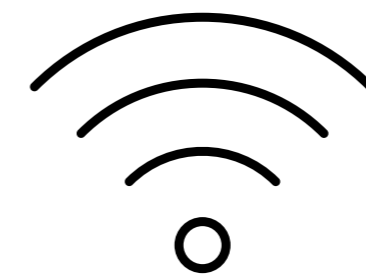

Wi-Fi Connectivity

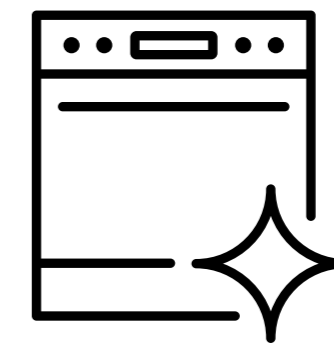

Self Clean

SAMSUNG