

# Gas Cooktop

---

## Installation manual

NA30N6555T\*/NA30N7755T\*  
NA36N6555T\*/NA36N7755T\*

---



**SAMSUNG**

**WARNING:** If the information in this manual is not followed exactly, a fire or explosion may result causing property damage, personal injury or death.

- **DO NOT** store or use gasoline or other flammable vapors and liquids in the vicinity of this or any other appliance.
- **WHAT TO DO IF YOU SMELL GAS:**
  - **DO NOT** try to light any appliance.
  - **DO NOT** touch any electrical switch.
  - **DO NOT** use any phone in your building.
  - Immediately call your gas supplier from a neighbor's phone. Follow the gas supplier's instructions.
  - If you cannot reach your gas supplier, call the fire department.
- Installation and service must be performed by a qualified installer, service agency, or the gas supplier.

## Contents

Before you begin	3
Important safety information	3
Gas cooktop components	8
What's in the box	8
Installation requirements	10
Pre-installation checklist	10
Location requirements	10
Gas supply requirements	12
Special gas requirements (gas models sold in Massachusetts)	13
Electrical requirements	13
Installation instructions	14
Installing your gas cooktop	14
Step 1. Unpack the cooktop	14
Step 2. Installing the cooktop.	14
Step 3. Connect the cooktop to gas supply	16
Step 4. Check for gas leaks.	17
Step 5. Electrical connections.	18
Step 6. Assemble the cooktop burners.	18
Step 7. Check the ignition of cooktop burners	20
Step 8. Checking the flame quality.	20
Step 9. Install the grates.	21
Step 10. Final installation checklist	22
LP (Propane) conversion instruction	22
Supplied parts	23
Converting the pressure regulator	24
Converting the cooktop burners	25
Adjusting low flame setting on cooktop burners	26

## Before you begin

### About this manual

READ THESE INSTRUCTIONS COMPLETELY AND CAREFULLY.

### Important note to the installer

- Read all instructions contained in these installation instructions before installing the cooktop.
- Remove all packing materials from the cooktop compartments before connecting the electric and gas supply to the cooktop.
- Observe all governing codes and ordinances.
- Be sure to leave these instructions with the consumer.
- Installation of this appliance requires basic mechanical skills.
- Proper installation is the responsibility of the installer.
- Product failure due to improper installation is not covered under the Warranty.

### Important note to the consumer

- Keep these instructions with your user manual for future reference.
- As when using any appliance generating heat, there are certain safety precautions you should follow.
  - Be sure your cooktop is installed and grounded properly by a qualified installer or service technician.
  - Make sure the wall coverings around the cooktop can withstand the heat generated by the cooktop.
  - Cabinet storage space above the cooktop burners should be a minimum of 30 in (76.2 cm).

### Important note to the servicer

The electrical diagram is attached inside the burner box.

## Important safety information

### READ ALL INSTRUCTIONS BEFORE USING THIS APPLIANCE

- All electrical and gas equipment with moving parts can be dangerous. Please read the important safety instructions for this appliance in this manual. The instructions must be followed to minimize the risk of injury, death, or property damage.
- Save this manual. Please Do Not Discard.

### Symbols used in this manual

#### **WARNING**

Hazards or unsafe practices that may result in severe personal injury or death.

#### **CAUTION**

Hazards or unsafe practices that may result in electric shock, personal injury, or property damage.

#### **NOTE**

Useful tips and instructions.

These warning icons and symbols are here to prevent injury to you and others. Please follow them explicitly. After reading this section, keep it in a safe place for future reference.

## Important safety information

### California Proposition 65 Warning



#### WARNING

Cancer and Reproductive Harm - [www.P65Warnings.ca.gov](http://www.P65Warnings.ca.gov).

### Commonwealth of Massachusetts

- This product must be installed by a licensed plumber or gas fitter qualified or licensed by the State of Massachusetts. When using ball-type gas shut-off valves, you must use the T-handle type. Multiple flexible gas lines must not be connected in series.

### General safety



#### WARNING

To reduce the risk of fire, electric shock, personal injuries, and/or death, obey the following precautions.

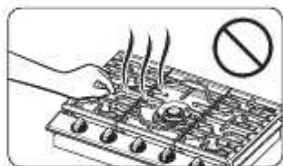

- Do not touch any part of the cooktop, including but not limited to, cooktop burners, during or immediately after cooking.
- Know the location of the gas shut-off valve and how to shut it off.

- Make sure the hold down brackets are properly installed on the cooktop. See the installation instructions for more information.
- Do not let children near, in, or on the cooktop. Do not let children play with the cooktop or any part(s) of the cooktop. Do not leave children unattended in an area where the cooktop is in use.
- Remove all packaging materials from the cooktop before operating to prevent ignition of these materials. Keep all packaging materials out of children's reach. Properly dispose the packaging materials after the cooktop is unpacked.
- Do not store any object of interest to children on the cooktop or backguard of the cooktop. Children climbing on the cooktop to reach items could be killed or seriously injured.

- Do not operate the cooktop if the cooktop or any part of the cooktop is damaged, malfunctioning, or missing parts.
- Do not use the cooktop as a space heater. This cooktop is to be used for cooking purposes only.
- Use only dry pot holders.
- Do not use the cooktop to heat unopened food containers.
- Unplug or disconnect power before servicing.

### Fire safety



#### WARNING

To reduce the risk of fire, electric shock, personal injuries, and/or death, obey the following precautions.



- Do not store, place, or use flammable or combustible materials such as paper, plastic, pot holders, linens, curtains, gasoline or other flammable vapors or liquids near the cooktop.
- Do not wear loose fitting or hanging garments while using the cooktop.
- To avoid grease buildup, regularly clean the vents.
- Do not let pot holders or other flammable materials touch a heating element. Do not use a towel or other bulky cloths in place of a pot holder.
- Do not use water on a grease fire. To put out a grease fire, turn off the heat source and smother the fire with a tight-fitting lid or use a multipurpose dry chemical or foam-type fire extinguisher.
- Do not heat unopened food containers - buildup of pressure may cause container to burst and result in injury.



## Gas safety

### ⚠ WARNING

To reduce the risk of fire, electric shock, personal injuries, and/or death, obey the following precautions.

If you smell gas:

- Close the valve and do not use the cooktop.
- Do not light a match, candle, or cigarette.
- Do not turn on any gas or electric appliances.



- Do not touch any electrical switches or plug a power cord into an outlet.
- Do not use any phone in your building.
- Evacuate the room, building, or area of all occupants.
- Immediately call your gas supplier from a neighbor's phone. Follow the gas supplier's instructions.
- If you cannot reach your gas supplier, call the fire department.

### Checking for gas leaks

- Leak testing of the appliance shall be conducted according to the manufacturer's instructions. Do not use a flame to check for gas leaks. Use a brush to spread a soapy water mixture around the area you are checking. If there is a gas leak, you will see small bubbles in the soapy water mixture at the leak point.

## Electrical and grounding safety

### ⚠ WARNING

To reduce the risk of fire, electric shock, personal injuries, and/or death, obey the following precautions.

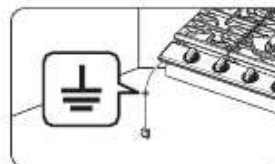

- Plug into a grounded 3-prong outlet.
- Do not remove the ground prong.
- Do not use an adapter or an extension cord.
- Do not use a damaged power plug, power cord, or loose power outlet.
- Do not modify the power plug, power cord, or power outlet in any way.
- Do not put a fuse in a neutral or ground circuit.
- Use a dedicated 120-volt, 60-Hz, 20-amp, AC, fused electrical circuit for this cooktop. A time-delay fuse or circuit breaker is recommended. Do not plug more than one appliance into this circuit.
- Do not connect the ground wire to plastic plumbing lines, gas lines, or hot water pipes.
- This cooktop **must be Earth grounded**. In the event of a malfunction or breakdown, grounding will reduce the risk of electrical shock by providing a path for the electric current. This cooktop is equipped with a cord having a grounding plug. The plug must be firmly plugged into an outlet that is properly installed and grounded in accordance with the local codes and ordinances. If you are unsure whether your electrical outlet is properly grounded, have it checked by a licensed electrician.
- The cooktop is supplied with a 3-pronged grounded plug. This cord must be plugged into a mating, grounded 3-prong outlet that meets all local codes and ordinances. If codes permit the use of a separate ground wire, we recommend that a qualified electrician determine the proper path for this ground wire.
- Electrical service to the cooktop must conform to local codes, Barring local codes, it should meet the latest ANSI/NFPA No. 70 - Latest Revision (for the U.S.) or the Canadian Electrical Code CSA C22.1 - Latest Revisions.
- It is the personal responsibility of the cooktop owner to provide the correct electrical service for this cooktop.

## Important safety information

### Installation safety

#### **WARNING**

To reduce the risk of fire, electric shock, personal injuries, and/or death, obey the following precautions:

- Have your cooktop installed and properly grounded by a **qualified installer**, in accordance with the installation instructions. Any adjustment and service should be performed only by qualified gas cooktop installers or service technicians.
  - **Do not attempt** to service, modify, or replace your cooktop or any part of your cooktop unless it is specifically recommended in this manual. All other service should be referred to a qualified technician.
  - Always use new flexible connectors when installing a gas appliance. **Do not use** old flexible connectors.
  - **Make sure** the hold down brackets are properly installed on the cooktop. See the installation instructions for more information.
  - **Remove** all tape and packaging materials.
  - **Remove** all accessories from the cooktop. Grates and griddles are heavy. Use caution when handling them.
  - **Make sure** no parts came loose during shipping.
- **Make sure** your cooktop is correctly installed and adjusted by a qualified service technician or installer for the type of gas (natural or LP) you will use. For your cooktop to utilize LP gas, the installer must replace the 5 cooktop burner orifices with the provided LP orifice set, and reverse the GPR adapter. These adjustments must be made by a qualified service technician in accordance with the manufacturer's instructions and all codes and requirements of the authority having jurisdiction. The qualified agency performing this work assumes the gas conversion responsibility.
  - Installation of this cooktop must conform with local codes or, in the absence of local codes, with the National Fuel Gas Code, ANSI Z223.1/NFPA 54, latest edition. In Canada, installation must conform with the current Natural Gas Installation Code, CAN/CGA-B149.1, or the current Propane Installation Code, CAN/CGA-B149.2, and with local codes where applicable. This cooktop has been design-certified by ETL according to ANSI Z21.1, latest edition, and Canadian Gas Association according to CAN/CGA-1.1, latest edition.

## Location safety

### ⚠ WARNING

To reduce the risk of fire, electric shock, personal injuries, and/or death, obey the following precautions.



- This cooktop is for indoor, household use only. **Do not install** the cooktop in areas exposed to the weather and/or water.
- **Do not install** the cooktop in a place which is exposed to a strong draft.

- Select a location where a grounded, 3- prong outlet is easily accessible.
- If the cooktop is located near a window, **do not hang** long curtains or paper blinds on that window.
- For the cooktop to ventilate properly, there is enough clearance at the top, back, sides, and underneath the cooktop. The vents allow the necessary exhaust for the cooktop to operate properly with correct combustion.
- **Make sure** the wall coverings around the cooktop can withstand heat up to 194 °F (90 °C) generated by the cooktop.
- Cabinet storage above the surface of the cooktop should be avoided. If cabinet storage above the cooktop is necessary: allow a minimum clearance of 30 inches (76.2 cm) between the cooking surface and the bottom of cabinets.

## Cooktop safety

### ⚠ WARNING

To reduce the risk of fire, electric shock, personal injuries, and/or death, obey the following precautions.

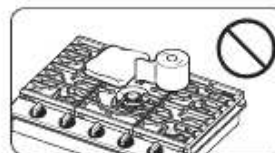

- **Make sure** all burners are off when not in use.
- **Do not use** aluminium foil to line the grates or any part of the cooktop.
- **Do not leave** burners unattended on medium or high heat settings.
- Before igniting, **make sure** all burner caps are properly in place and all burners are level.
- Always use the LITE position when igniting the burners and make sure the burners have ignited. If ignition fails, turn the knob to OFF and wait until the gas has dissipated.
- When you set a burner to simmer, **do not turn** the knob quickly. Make sure the flame stays on.
- **Do not** place any objects other than cookware on the cooktop.
- This cooktop is designed to cook with a wok or wok ring attachment. If foods are flamed, they should only be flamed under a ventilation hood that is on.
- Before removing or changing cookware, turn off the burners.
- Remove food and cookware immediately after cooking.
- Before removing any parts of the burner for cleaning, make sure the cooktop is off and completely cool.
- After cleaning the burner spreader, **make sure** it is completely dry before re-assembling.
- To avoid carbon monoxide poisoning, **do not pour** water into the cooktop well while cleaning.
- Select cookware that is designed for top-cooktop cooking. Use cookware that is large enough to cover the burner grates. Adjust the burner flames so that the flames do not extend beyond the bottom of the cookware.
- To avoid cookware discoloration, deformity, and/or carbon monoxide poisoning, **do not use** cookware that is exceedingly larger than the grate.
- **Make sure** cookware handles are turned to the side or rear of the cooktop, but not over other cooktop burners.

## Important safety information

- Stand away from the cooktop while frying.
- Always heat frying oils slowly, and watch as they heat. If you are frying foods at high heat, carefully watch during the cooking process. If a combination of fats or oils is to be used during frying, mix them together before heating.
- Use a deep-fryer thermometer whenever possible. This prevents overheating the fryer beyond the smoking point.
- Use a minimum amount of oil when shallow pan-frying or deep-frying. Avoid cooking unfrozen food or food with excessive amounts of ice.
- Before moving cookware full of fats or oils, make sure it has completely cooled.
- To prevent delayed eruptive boiling, always allow heated liquids to stand at least 20 seconds after you have turned off the burner so that the temperature in the liquid can stabilize. In the event of scalding, follow these first aid instructions:
  1. Immerse the scalded area in cool or lukewarm water for at least 10 minutes.
  2. Do not apply any creams, oils, or lotions.
  3. Cover with a clean, dry cloth.

## Gas cooktop components

### What's in the box

#### Parts supplied

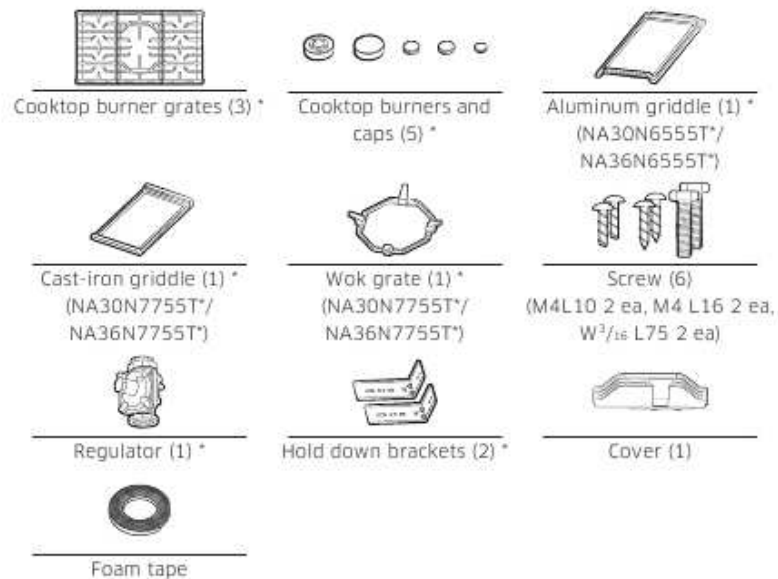







- Make sure you have received all of the supplied parts shown above.
- If your cooktop was damaged during shipping or you do not have all of the supplied parts, contact your local retailer.

#### NOTE













If you need an accessory marked with an \* (asterisk), please contact the Samsung Call Center using the phone number listed on the last page of this manual or visit our on-line parts web site at [www.samsungparts.com](http://www.samsungparts.com).



**Parts needed**

			
Gas line shut-off valve	Flexible metal appliance connector 1/2 in (ID) x 5 ft	Flare union adapter 3/4 in or 1/2 in (NPT) x 1/2 in (ID)	Flare union adapter 1/2 in (NPT) x 1/2 in (ID)
			
135-degree elbow (optional)	90-degree elbow (optional)		

**Tools needed**

			
Flat-blade screwdriver	Phillips screwdriver	Open-end or adjustable wrench	Pipe wrench (2)
			
1/4" Nut driver	Pencil and ruler	Level	Pipe joint compound
			
Utility knife	Soapy water solution	Pliers	Saber saw

Gas cooktop components

# Installation requirements

## Pre-installation checklist

1. When preparing cooktop opening, make sure the inside of the cabinet, and the cooktop do not interfere with each other.
2. Remove packing materials, grate boxes, regulator with literature, and literature package from the cooktop before beginning installation.

## Location requirements

**BEFORE YOU BEGIN** to install this appliance, refer to the following information, dimensions, and clearances. These dimensions must be met for safe use of the cooktop. The location of the electrical outlet and gas piping may be adjusted to meet the following dimensions and clearances.

### ⚠ CAUTION

This cooktop has been designed to comply with the maximum allowable wood cabinet temperature of 194 °F (90 °C). Make sure the wall covering, countertops, and cabinets around the cooktop can withstand the heat (up to 194 °F (90 °C)) generated by the cooktop. If not, discoloration, delamination, or melting may occur.

Maintain the following minimum clearance dimensions

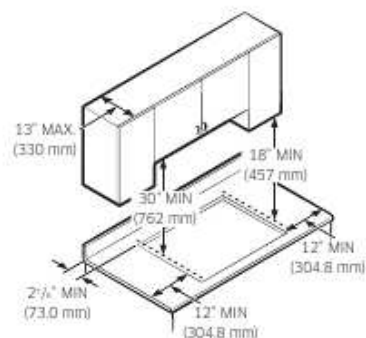

30" - NA30N6555T\* / NA30N7755T\*

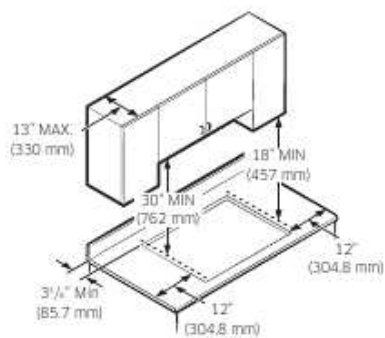

36" - NA36N6555T\* / NA36N7755T\*

### NOTE

All horizontal clearances must be maintained for a minimum of 18" (457 mm) above the cooking surface.

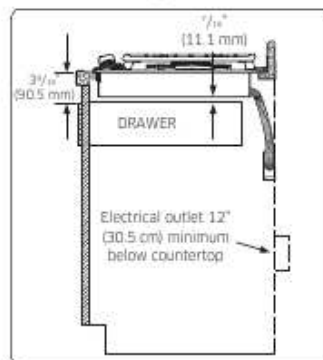

### NOTE

Allow 7/16" minimum vertical clearance from the cooktop bottom (or 3 9/16" minimum depth from the countertop) to any combustible surfaces, including the upper edge or a drawer installed below the cooktop.

## Installation over built-in oven

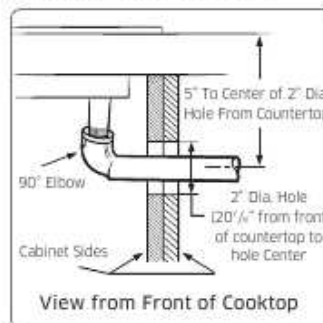

See built-in oven installation for complete installation instructions.

### Overall cooktop dimensions

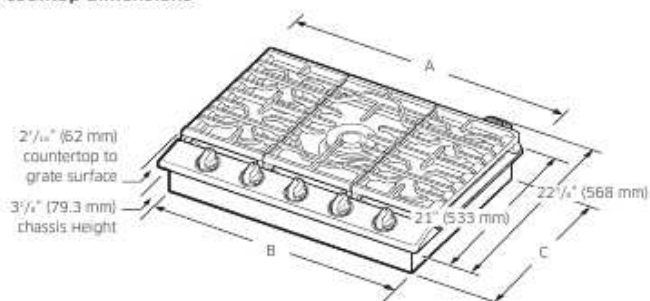

Model	A	B	C
NA30N6555T*	30"	28 <sup>1</sup> / <sub>8</sub> "	19 <sup>3</sup> / <sub>8</sub> "
NA30N7755T*	(762 mm)	(715 mm)	(492.1 mm)
NA36N6555T*	36"	33 <sup>11</sup> / <sub>16</sub> "	18 <sup>7</sup> / <sub>8</sub> "
NA36N7755T*	(914.4 mm)	(855 mm)	(479 mm)

### Cutout dimensions of countertop

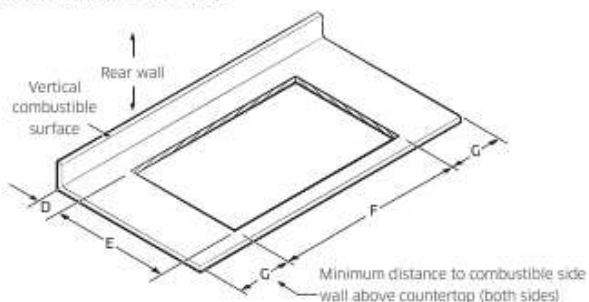

Model	(D) Min.	(E) Min.	(F) Min.	(G) Min.
NA30N6555T*	2 <sup>7</sup> / <sub>8</sub> "	19 <sup>5</sup> / <sub>8</sub> "	28 <sup>1</sup> / <sub>2</sub> "	12"
NA30N7755T*	(73 mm)	(498.5 mm)	(723.9 mm)	(304.8 mm)
NA36N6555T*	3 <sup>3</sup> / <sub>8</sub> "	19 <sup>1</sup> / <sub>8</sub> "	33 <sup>7</sup> / <sub>8</sub> "	12"
NA36N7755T*	(85.7 mm)	(485.8 mm)	(860.4 mm)	(304.8 mm)

### Installation dimensions with downdraft hood

#### NOTE

- Make sure the clearance dimensions when you install the cooktop with downdraft hood.
- The cooktop can be installed after detaching Smart Connect module. Please refer to the instruction how to detach Smart Connect module on page 15.

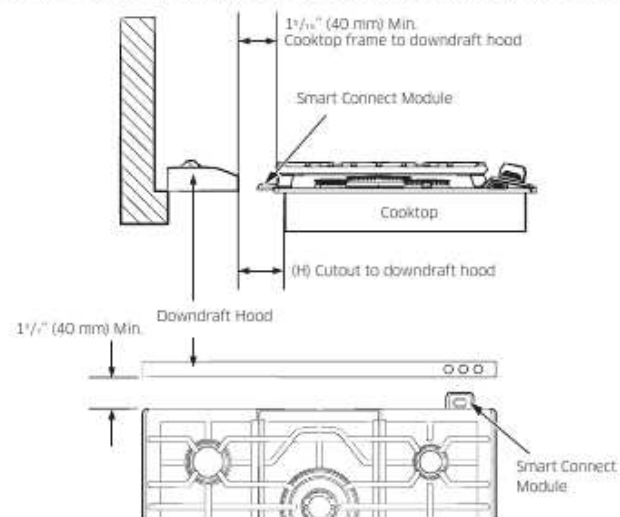

Model	(H) Min.
NA30N6555T*	2 <sup>7</sup> / <sub>16</sub> " (62 mm)
NA30N7755T*	
NA36N6555T*	3" (76 mm)
NA36N7755T*	

Installation requirements

## Installation requirements

### Single Oven Under counter

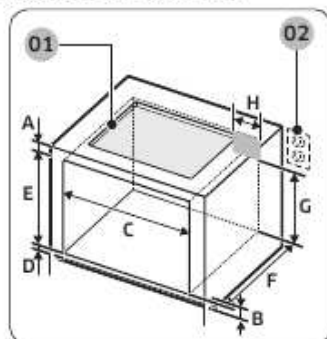

- 01** This cooktop can be installed above any Samsung single built-in oven. Refer to installation manual of oven.
- 02** Gas and Electrical Connections for Gas Cooktop Must be Located in an Adjacent Accessible Location to the Right.

	Size
A	Min. 3 <sup>3</sup> / <sub>4</sub> " (9.5 cm)
B	4" (10.1 cm)
C	Min. 28 <sup>1</sup> / <sub>2</sub> " / Max. 28 <sup>5</sup> / <sub>8</sub> " (Min. 72.4 cm / Max. 72.7 cm)
D	Min. 1" / Max. 1 <sup>1</sup> / <sub>4</sub> " (Min. 2.5 cm / Max. 3.2 cm)
E	Min. 27 <sup>1</sup> / <sub>4</sub> " / Max. 27 <sup>3</sup> / <sub>8</sub> " (Min. 69.2 cm / Max. 69.5 cm)
F	24" (61 cm)
G	Min. 22" (Min 55.9 cm)
H	Max. 9 <sup>1</sup> / <sub>2</sub> " (Max. 24.1 cm) - Junction Box

### Utility locations and dimensions

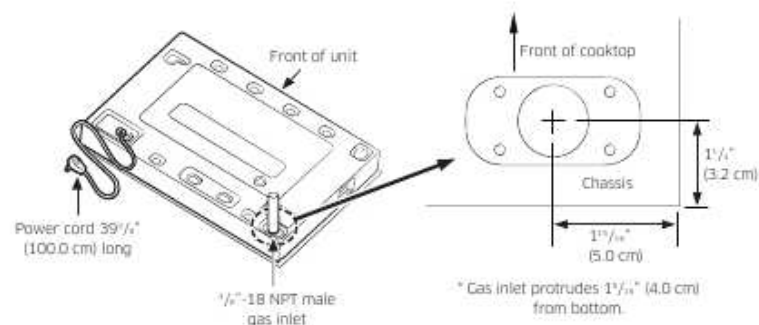

### Gas supply requirements

#### Provide adequate gas supply

This cooktop is designed to operate at a pressure of 5 in (13 cm) of water column on natural gas or 10 in (25 cm) of water column on LP gas (propane or butane).

Make sure you are supplying your cooktop with the type of gas for which it is designed. Do not attempt to convert the appliance from the gas specified in this manual to a different gas without consulting the gas supplier.

This cooktop is convertible for use on natural or propane gas. If you decide to use this cooktop on LP gas, conversion must be made by a qualified LP installer before attempting to operate the cooktop.

For proper operation, the pressure of natural gas supplied to the regulator must be between 5 in and 13 in (13 cm and 33 cm) of water column.

For LP gas, the pressure supplied must be between 10 in and 13 in (25 cm and 33 cm) of water column.

When checking for proper operation of the regulator, the inlet pressure must be at least 1 in (2.5 cm) greater than the operating (manifold) pressure as given.





The pressure regulator located at the inlet of the cooktop manifold must remain in the supply line regardless of whether natural or LP gas is being used.

**NOTE**

- The cooktop comes from the factory with a regulator in the shipping carton. Use only the regulator provided. The regulator must be installed in the gas line that runs from the cooktop gas inlet to the gas shut off valve.
- An external manual shut-off valve must be installed between the gas inlet and the cooktop for the purpose of turning on or shutting off gas to the appliance.
- Be sure the connectors are installed when you need coupling by a qualified installer.
- Never reuse old connectors when installing the cooktop. The use of old connectors can cause gas leaks and personal injury. Always use new flexible connectors when installing a gas appliance.

**Special gas requirements (gas models sold in Massachusetts)**

**COMMONWEALTH OF MASSACHUSETTS REQUIREMENTS:**

**WARNING**

- Gas leaks may occur in your system, creating a dangerous situation.
- Gas leaks may not be detected by smell alone.
  - Gas suppliers recommend you purchase and install a UL-approved gas detector. Gas detector should be installed in accordance with the manufacturers instructions.
  - Cooktop must be installed by a qualified plumber or gas fitter by the State of Massachusetts.
  - A T-handle manual gas valve MUST be installed in the gas supply line to your cooktop.
  - If a flexible gas connector is used to install your cooktop, multiple flexible gas lines must not be connected in series.

**Electrical requirements**

**WARNING**

- It is the owner's responsibility to make sure that the electrical service meets electrical requirements and that the electrical outlet has been properly installed by a licensed electrician.
- To reduce the risk of fire, electric shock, or personal injury:

**All cooktops**

- Do not use an extension cord or adapter plug with this cooktop.
- This cooktop must be properly grounded.
- Check with a qualified electrician if you are in doubt as to whether your cooktop is properly grounded.
- Do not modify the plug provided with your cooktop – if it doesn't fit the outlet, have a proper outlet installed by a qualified electrician.
- All wiring and grounding must be done in accordance with local codes or, in the absence of local codes, with the National Electrical Code, ANSI/NFPA No. 70 – Latest Revision (for the U.S.) or the Canadian Electrical Code CSA C22.1 – Latest Revisions and local codes and ordinances.
- Wiring diagram is located on the inside of the burner box.
- This cooktop is equipped with an electronic ignition system that will not operate if plugged into an outlet that is not properly polarized.

**Gas cooktops**

- All gas models are equipped with a power cord with an equipment-grounding conductor and a grounding plug.
- A 120-Volt, 60-Hz, AC, approved electrical service with 20-amp circuit breaker or time-delay fuse is required for all U.S. and Canadian models.



### Grounding

- All cooktops must be grounded for personal safety.
- The plug must be firmly plugged into a three-prong outlet that is properly installed and grounded in accordance with all local codes and ordinances. In the event of a malfunction or breakdown, grounding will decrease the risk of electrical shock by providing a path for the electric current.
- Do not use a damaged power plug or loose wall outlet.
- Do not use an extension cord or adapter with this appliance.
- Do not, under any circumstances, cut, modify, remove, or otherwise defeat the grounding (third) prong from the power cord. If the plug and the outlet do not match or you have any doubt, have a qualified electrician install the proper outlet. The customer should have the wall receptacle and circuit checked by a qualified electrician to make sure the receptacle is properly grounded.
- NEVER connect ground wire to plastic plumbing lines, gas lines, or water pipes.

### ⚠ CAUTION

Failure to follow these instructions can result in death, fire, or electrical shock.

### Additional installation requirements for mobile homes

The installation of appliances designed for mobile home installation must conform with the Manufactured Home Construction and Safety Standard, Title 24 CFR, Part 3280 (formerly the Federal Standard for Mobile Home Construction and Safety, Title 24, HUD, Part 280) or, when such standard is not applicable, the Standard for Manufactured Home Installations, latest edition (Manufactured Home Sites, Communities and Set-Ups), ANSI A225.1, latest edition, or with local codes. In Canada, mobile home installation must be in accordance with the current CAN/CSA Z240/MH Mobile Home Installation Code.

## Installation instructions

### Installing your gas cooktop

#### IMPORTANT:

Please read the following instructions, as well as the Important Safety Instructions section at the front of this manual, completely and carefully BEFORE installing and/or operating the gas cooktop. Improper installation, adjustment, service, or maintenance can cause personal injury or property damage.

#### NOTE

To ensure proper installation, we strongly recommend that you hire a professional installer.

#### Step 1. Unpack the cooktop

Remove all packaging materials. Failure to remove packaging materials could result in damage to the appliance.

Inventory all loose parts against the Parts supplied components listed on page 8.

Check for shipping damage and/or missing parts. Any damage and/or missing parts should be reported to your local retailer.

#### Step 2. Installing the cooktop.

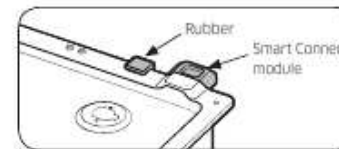

#### ⚠ CAUTION

- When inserting the cooktop into the cutout opening, do not remove the rubber piece protecting Smart Connect module. Protecting rubber piece should be removed after carefully inserting the cooktop.



- When mounting the cooktop, make sure to insert the cooktop with the front side first. Inserting from the rear may damage the Wi-Fi module.

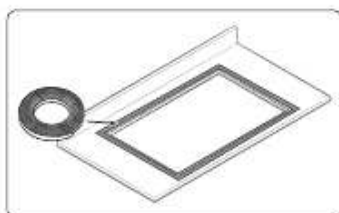

1. Locate electrical outlet and gas shut-off valve beneath cabinet.
2. Apply the foam tape around the edge of the cutout opening. Do not overlap the foam strips.
  - The foam strip helps avoid damage to the underside of the cooktop from debris and helps the cooktop sit flat on uneven counters.

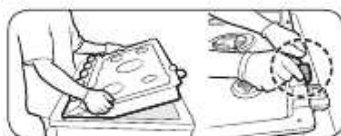

Correct installation

3. Protect surface of cooktop
  - Place a towel or tablecloth onto the countertop.
4. With bottom side first, gently put the cooktop down. Then, slightly lift up the rear to remove the protective rubber for the Wi-Fi module.
  - Make sure the front of the countertop is parallel to the cooktop
  - Make final check that all required clearances are met.

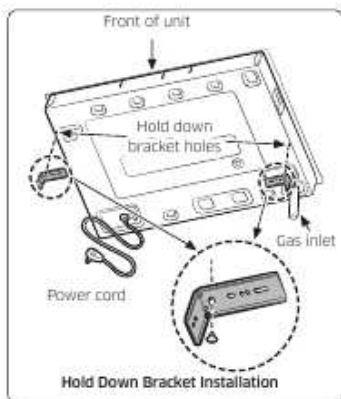

5. Secure the cooktop to the countertop using the two provided hold-down brackets as shown.

### Hold down bracket install guide

Case 1.

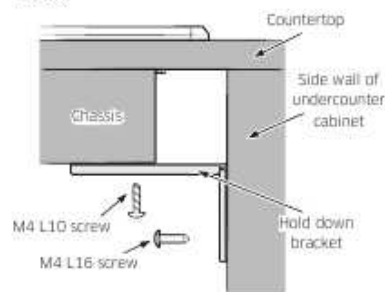

Case 2.

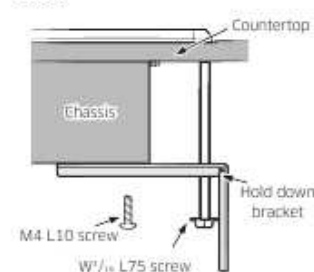

### NOTE

Smart Connect module can/must be detached before installation of the cooktop in following cases:

- The consumer doesn't need to Smart connect function.
- Installation is not possible because the Smart Connect module protrudes against the rear wall of the countertop.
- The downdraft hood is installed and protrudes against the Smart Connect module.

The Cover must be installed in place of Smart connect module if Smart connect module has been removed. Please read following instructions on how to detach Smart connect module.

## Installation instructions

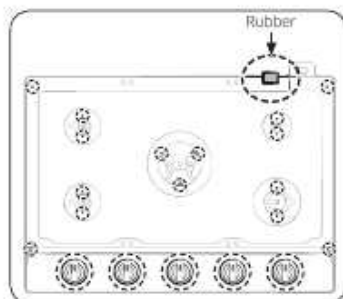

1. Remove screws from all 5 burner cups and 4 screws from the cooktop frame. Remove the rubber protecting Smart connect module. Pull out all knob dials and lift up to remove the frame cooktop.



2. Detach Smart connect module from case burner. Disconnect wire connector from the PCB.

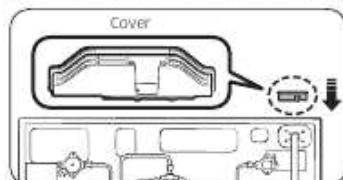

3. Install supplied cover in place of Smart connect module.

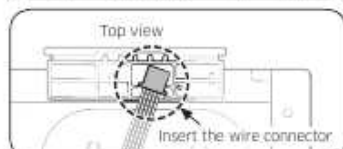

4. Insert the wire connector diagonally into the cover. Make sure it fits firmly.

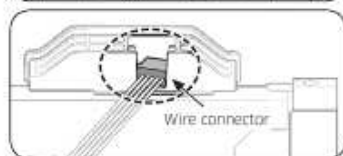

5. Return all burner cups and cooktop frame to original position, reinstall all knob dials.

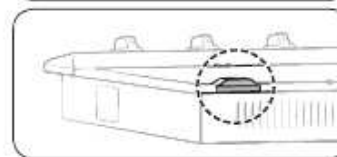

### Step 3. Connect the cooktop to gas supply

Shut off the main gas supply valve before disconnecting the old cooktop and leave it off until the new hookup has been completed. Don't forget to relight the burner on other gas appliances when you turn the gas back on.

Because hard piping restricts movement of the cooktop, the use of a CSA International-certified flexible metal appliance connector is recommended unless local codes require a hard-piped connection.

#### ⚠ WARNING

If the information in this manual is not followed exactly, a fire or explosion may result, causing death, personal injury, or property damage.

- Do not store or use gasoline or other flammable vapors and liquids in the vicinity of this or any other appliance.
- WHAT TO DO IF YOU SMELL GAS:
  - DO NOT light a match, candle, or cigarette.
  - DO NOT try to light any appliance.
  - DO NOT touch any electrical switch.
  - DO NOT use any phone in your building.



- Clear the room, building, or area of all occupants.
  - Immediately call your gas supplier from a neighbor's phone. Follow the gas supplier's instructions.
  - If you cannot reach your gas supplier, call the fire department.
- Installation and service must be performed by a qualified installer, service agency, or gas supplier.
  - Do not install the cooktop without also installing the included gas regulator. Do not use the cooktop without the regulator installed.
  - Ensure that the arrow on the regulator points in the direction of the gas flow, towards the cooktop.
  - Do not apply excessive pressure when tightening gas connections and fittings.
  - Test the gas lines for leaks as instructed before use. Do not use a flame to check for leaks.

Never use an old connector when installing a new cooktop. If the hard-piping method is used, you must carefully align the pipe; the cooktop cannot be moved after the connection is made.

To prevent gas leaks, apply pipe-joint compound or wrap pipe-thread tape with Teflon on all male (external) pipe threads.

1. Attach the gas pressure regulator (included with the cooktop) to the cooktop pipe nipple inlet. For tight installations, the regulator may be installed upstream from the pipe nipple, anywhere between the shut-off valve and the cooktop. For best performance, minimize gas pressure loss by attaching the regulator as close as possible to the cooktop gas inlet.
2. Complete connection of the gas supply to the cooktop by installing a flexible gas line between the pressure regulator and the shut-off valve.

#### **⚠ WARNING**

Do not exceed 25 ft-lbs of torque when making gas line connections. Overtightening may crack the pressure regulator resulting in a gas leak.

#### **Flexible connector hookup**

Installer: Inform the consumer of the location of the gas shut-off valve.

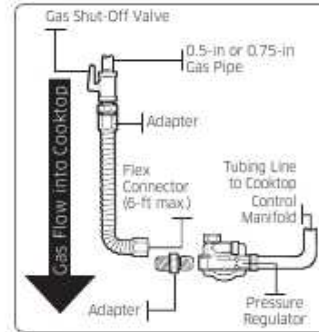

#### **NOTE**

The gas shut-off valve should be installed in an accessible location in the gas piping, external to the appliance, for the purpose of turning on or shutting off the gas to the appliance.

#### **Step 4. Check for gas leaks.**

#### **⚠ WARNING**

To prevent death, personal injury, explosion, and/or fire hazard, DO NOT use a flame to check for gas leaks.

When using test pressures greater than 1/2 psig to pressure-test the gas supply system of the residence, disconnect the cooktop and individual shut-off valve from the gas supply piping. When using test pressures of 1/2 psig or less to test the gas supply system, simply isolate the cooktop from the gas supply system by closing the individual shut-off valve.

1. When all connections have been made, make sure all cooktop controls are in the off position and turn on the main gas supply valve.
2. Use a liquid leak detector at all joints and connections to check for leaks in the system.
3. Tighten all connections if necessary to prevent gas leakage in the cooktop or supply line.

# Installation instructions

## Step 5. Electrical connections.

### ⚠ WARNING

- Disconnect all electrical power of the main circuit breaker or fuse box before installing.
  - BEFORE OPERATING OR TESTING, follow the grounding requirements on pages 14 in this manual. Improper connection of the grounding plug can result in a risk of electric shock.
  - All gas cooktops come with a power cord. The power cord is connected to the bottom of the cooktop. Please review "Electrical requirements" on pages 13.
  - The electrical system, including the power cord, is preinstalled and prewired at the factory. Altering any part of this system may result in a short or overload.
1. Plug in the power cord. Make sure the outlet meets local or national electrical codes as referenced on pages 13.
  2. Check the gas supply line to make sure it did not get damaged and it stayed connected during positioning.

## Step 6. Assemble the cooktop burners.

### ⚠ CAUTION

- Do not operate the cooktop burners without all burner parts in place.
- Be careful not to push in any cooktop controls while removing the cooktop burner. A slight electrical shock might result which could cause you to knock over hot cookware.
- Do not remove the top or touch the electrode of any burner while another burner is turned on. Electrical shock might result.

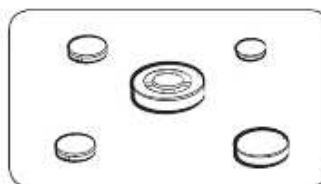

1. Position cooktop burner heads on top of the cooktop burner manifolds as shown on the right. The electrodes will fit into the slot in the bottom of the heads. Make sure the cooktop burner heads are flat and parallel with the cooktop.
2. Place the matching size caps on top of each cooktop burner head.

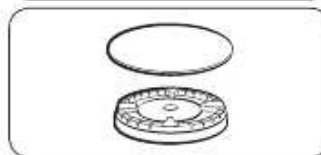

### Dual Burner head



1. As shown, insert the marked area of burner head into the matching area of burner cup so that they line up.

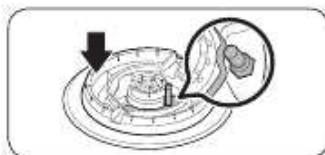

2. Install the burner head so that the electrode passes through the opening for the electrode. Make sure the burner head lies flat on the stove top.

#### Round Burner head



1. Orient the burner head so that the opening for the electrode lines up with the electrode.



2. Install the burner head so that the electrode passes through the opening for the electrode. Make sure the burner head lies flat on the stove top.



#### CAUTION

Make sure all burner components (heads and caps) are reinstalled properly. They will be stable and rest flat when correctly installed.

#### Burner Cap

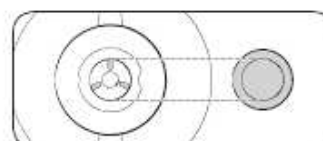

1. Match the burner caps to the burners by size, and then re-install the caps on the burner heads.

#### CAUTION

Make sure each cap is re-installed on the correct burner head, is centered on the burner head, and lies flat.

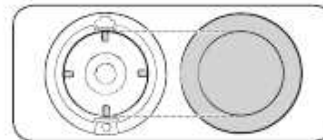
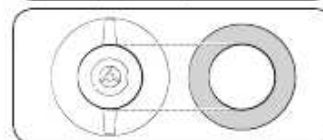

#### CAUTION

Make sure all burner components (heads and caps) are reinstalled properly. They will be stable and rest flat when correctly installed.

Top	Bottom

#### NOTE

The precise simmer burner (RR) cap and the inner Dual burner (Center) cap are interchangeable.

## Installation instructions

### Step 7. Check the ignition of cooktop burners

Check the operation of all cooktop burners after the cooktop has been installed and assembled, gas supply lines have been carefully checked for leaks, and electrical power cord has been plugged in.

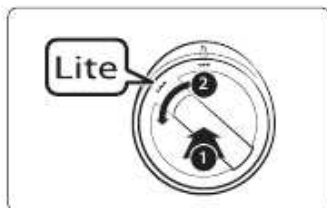

#### To turn on a cooktop burner

1. Push in and turn the control knob for that cooktop burner to the Lite position. The "clicking" sound indicates the electronic ignition system is operating properly. The burner will light in about 4 seconds, after the air has been purged from the supply line.
2. After the burner lights, turn the control knob to the desired setting. The "clicking" sound will stop and the flame height will change from Max. to Min. during turning the control knob.
3. Repeat steps 1 and 2 to check the operation of each cooktop burner in succession.

#### NOTE

- If the burner does not light within 4 seconds, turn the knob off and wait one minute before trying again.
- When you push in and turn the control knob, all spark igniters will make a series of sparks, but only the burner turned to Lite will light.

### Step 8. Checking the flame quality.

All combustion flames need to be visually checked to determine their flame quality.

#### CAUTION

If you attempt to measure the flame, please use caution. Burns could result.

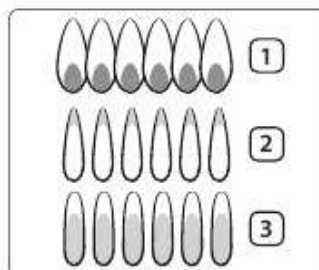

1. **Soft blue flames**—Normal for natural gas operation.
2. **Yellow tips on outer cones**—Normal for LP gas operation.
3. **Yellow flames**—Abnormal for any gas operation; call for service.

#### NOTE

If burner flame looks like 3, the cooktop should not be used until it is serviced. Call for service. Normal burner flames shall look like 1 or 2, depending on the gas type you use.



### Step 9. Install the grates.

#### NOTE

Install the grates as instructed below for longest life. When installed properly, the openings in the grates are centered over the burners.

The three cooktop grates are designed to fit in specific positions on the cooktop. For maximum stability, these grates should only be used in their proper positions.

- Please place the grate marked with the letter 'L' on the left side, and the one with the letter 'R' on the right side.
- The middle grate must be installed with the filled-in section, marked 'BACK', oriented towards the back of the cooktop.

The back of the right grate is notched to help you orient the grates correctly. See the illustration below.

To replace the grates correctly, follow these steps:

1. Locate the notch on the back of the right grate.
2. Orient the right grate so that it is on the right side of the cooktop with the notch in the back.
3. Gently lower the legs of the right grate into the corresponding dimples on the cooktop.
4. Gently lower the legs of the remaining two grates into the corresponding dimples on the cooktop as shown in the illustration.

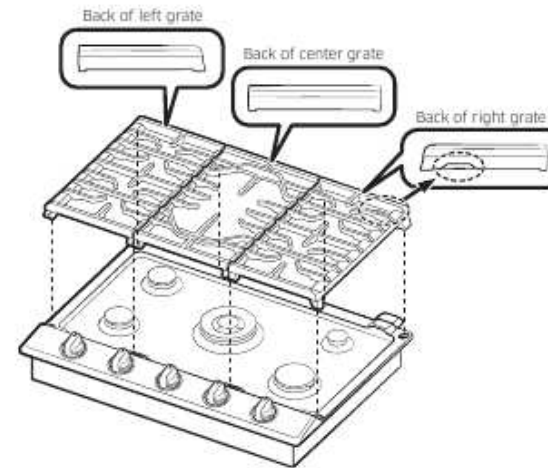

# Installation instructions

## Step 10. Final installation checklist

### **▲ WARNING**

- To ensure a safe and proper installation, the following checklist should be completed by the installer to ensure that no part of the installation has been overlooked.
- Proper installation is the responsibility of the homeowner. The importance of proper installation of your Samsung cooktop cannot be overemphasized.

**You have just completed installing your cooktop.** Make sure all control knobs are in the off position. The following is a checklist to confirm your cooktop is safely installed and ready for operation.

- Gas line has been properly connected to the cooktop. The gas has been turned on.
  - All connections have been checked for leaks.
- The cooktop is plugged into the properly grounded electrical receptacle.
- The cooktop burners and grates have been properly assembled.
- All burners have been tested for proper operation.

## LP (Propane) conversion instruction

### **▲ WARNING**

- This conversion must be performed by a qualified installer or gas supplier in accordance with the manufacturer's instructions and all codes and requirements of the authority having jurisdiction. Failure to follow ALL instructions could result in serious injury or property damage. The qualified agency performing this work assumes responsibility for the conversion.
- Know the location of the gas shut-off valve and how to shut it off if necessary.
- Unplug or disconnect power before servicing.
- Do not operate the cooktop burners when using LP gas before converting the pressure regulator and burner orifices for LP gas use. Failure to do so could cause high flames and toxic fumes which can result in serious injury.
- Do not mix up or substitute LP gas burner orifices during conversion process. Improper orifice placement will effect burner and cooking performance and could result in personal injury and/or product damage.

All Samsung gas cooktops are manufactured and shipped to be used with natural gas. The cooktop are also shipped with LP Conversion Kits, so the cooktop can be converted to be used with LP gas. The kits consist of a set of properly-sized burner orifices to be used in the cooktop burners. These orifices will be positioned in a sheet of cardboard and placed in a plastic bag. The bag is placed with a user manual. The orifice in the pressure regulator is a dual-purpose orifice, one side for natural gas and the other for LP gas.

## Supplied parts

The following parts make up the LP conversion kit:



NA30N6555T\* / NA36N6555T\*



NA30N7755T\* / NA36N7755T\*

The all orifices' positions are marked on the provided sheet. The spud in the pressure regulator is factory-installed for Natural Gas (NG) use. LP conversion requires spud removal and reinstallation for LP use.

BURNER ORIFICE SIZES AND OUTPUT RATINGS (LP Gas [Propane] 10 in WCP)		
Burner Location	BTU Rate	Orifice size [mm]
RF	11,500	1.04
LF	7,500	0.83
RR	4,000	0.62
LR	7,500	0.83
Center <sup>1</sup>	14,500	In: 0.46 / Out: 0.74 (2 pcs)
Center <sup>2</sup>	16,500	In: 0.46 / Out: 0.83 (2 pcs)

<sup>1</sup>Model NA30N6555T\* / NA36N6555T\*

<sup>2</sup>Model NA30N7755T\* / NA36N7755T\*

## BURNER ORIFICE SIZES AND OUTPUT RATINGS (Natural Gas 5 in WCP)

Burner Location	BTU Rate	Orifice size [mm]
RF	13,000	1.64
LF	9,500	1.40
RR	5,000	1.01
LR	9,500	1.40
Center <sup>1</sup>	19,000	In: 0.70 / Out: 1.30 (2 pcs)
Center <sup>2</sup>	22,000	In: 0.85 / Out: 1.36 (2 pcs)

<sup>1</sup>Model NA30N6555T\* / NA36N6555T\*

<sup>2</sup>Model NA30N7755T\* / NA36N7755T\*

### NOTE



Orifice markings:

115 – Denotes 1.15 mm orifice size opening.

## Installation instructions

### Required tools



Adjustable wrench



1/2" open-end wrench



Screwdrivers: Phillips



Small flat-bladed  
precision screwdriver



Nut drivers: 9/32" or 7  
mm

To convert your for use with LP gas, perform the following steps and procedures:

1. Disconnect electrical power to the cooktop. Unplug the cooktop power cord, trip the circuit breaker, or remove the fuse from the fuse box.
2. Shut off the gas supply to the cooktop. Close the manual shut-off valve to the cooktop.

### Converting the pressure regulator

#### NOTE

If you are using LP gas to fuel the cooktop, the following steps and conversions must be made before the flames can be adjusted.

1. Using your fingers, turn the cap. And carefully look at the spring retainer to locate the NAT or LP position.

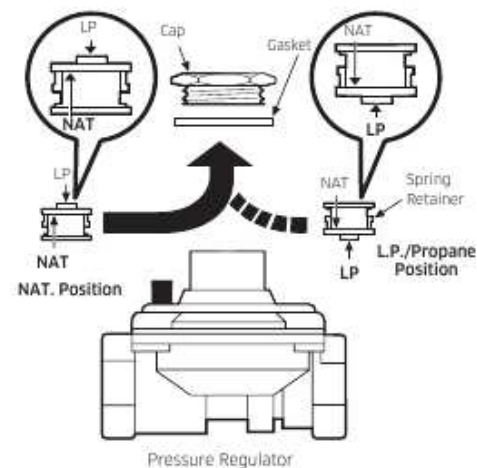

2. Turn the spring retainer over by rotating it 90 deg., pull it from the cap, turn the spring retainer over so that LP is showing, insert it back into the cap, and then rotate it 90 deg. into position.
3. Screw the cap back onto the regulator and tighten.



## Converting the cooktop burners

### NOTE

If you are using LP gas to fuel the cooktop, the following steps and conversions must be made before the flames can be adjusted.

1. Lift off the cooktop burner caps and the cooktop burner heads from the cooktop burner manifold cups.



2. Using a  $\frac{9}{32}$ " or 7 mm nut driver, remove the burner orifice from the bottom of each burner manifold cup.

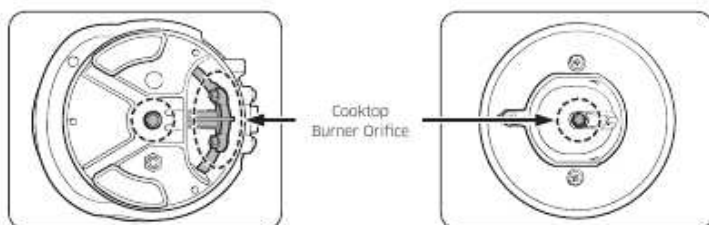

### NOTE

Save these orifices and note their positions for future conversions back to natural gas.

3. Locate the LP conversion orifices that were shipped with the cooktop.
4. Identify the proper orifice by orifice size for each of the cooktop burners.
5. Install the proper orifices in each of the burner manifold cups and tighten with a  $\frac{9}{32}$ " or 7 mm nut driver.

### NOTE

Any other placement of orifices could result in dangerous operating conditions and/or poor cooking results.

6. Set all burner heads on top of the manifold cups in the same location as they were removed. The hole on the side of the burner heads goes over the electrodes. The burner heads are correctly installed when they are flat on the top of the manifold cups.
7. Set all burner caps on top of the burner heads. These are also flat when they are installed to ensure proper safe operation.

# Installation instructions

## Adjusting low flame setting on cooktop burners

All Cooktop burner flames should be checked at their lowest setting. Use the following steps to check and adjust the cooktop burner settings.

### NOTES

- Low setting adjustments should always be made with two or more burners operating at the same time.
  - Call for service when you need to adjust the inner flame of the cooktop center burner settings.
1. Turn on two or more cooktop burners and set them between MED and HI.
  2. Quickly turn one of the control knobs counterclockwise to the lowest setting. The flame should stay lit. If the flame flutters or goes out, adjust the bypass valve on the control valve for that burner.
  3. Pull the control knob for that burner straight off.
  4. Using a small flat-bladed screwdriver, adjust the bypass valve screw in the base of the valve stem. Turn the bypass valve screw counter clockwise to increase the flame size.

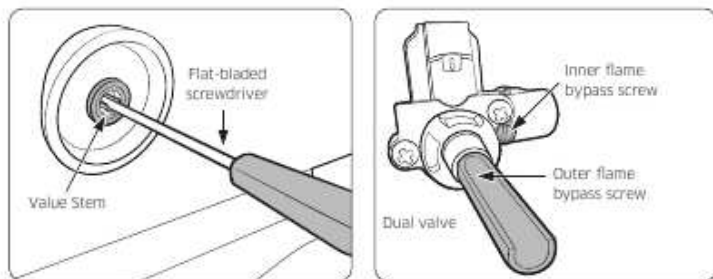

5. Replace control knob and recheck the low flame setting.
6. Repeat step 1 thru 5 to check and adjust the low flame settings on the remaining cooktop burners.

## Combustion flame quality

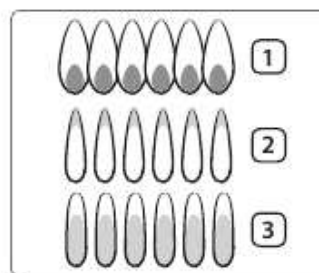

1. **Soft blue flames**—Normal for natural gas operation.
2. **Yellow tips on outer cones**—Normal for LP gas operation.
3. **Yellow flames**—Abnormal for any gas operation. Further adjustment required.

## Additional low flame check

1. Quickly open and close the cabinet door while the cooktop burner is set on LO. If the flame is extinguished, increase the low flame setting and repeat the test until the flame is stable.
2. Turn the knob from HI to the lowest setting quickly. If the flame goes out at the lowest setting, increase the low flame setting and repeat the test until the flame is stable.

### WARNING

1. Do not completely remove the valve set screw from the valve stem. The valve set screw is an integral part of the gas valve assembly. Removing the valve set screw will cause gas to leak.
2. After adjusting the valve set screw, inspect the assembly for gas leaks.

Memo

---

# SAMSUNG



Scan this with your smartphone

Scan the QR code\* or visit  
[www.samsung.com/spsn](http://www.samsung.com/spsn)  
to view our helpful  
How-to Videos and Live Shows  
\*Requires reader to be installed on your  
smartphone

## QUESTIONS OR COMMENTS?

COUNTRY	CALL	OR VISIT US ONLINE AT
U.S.A Consumer Electronics	1-800-SAMSUNG (726-7864)	<a href="http://www.samsung.com/us/support">www.samsung.com/us/support</a>
CANADA	1-800-SAMSUNG (726-7864)	<a href="http://www.samsung.com/ca/support">www.samsung.com/ca/support</a> (English) <a href="http://www.samsung.com/ca_fr/support">www.samsung.com/ca_fr/support</a> (French)



DG68-01091A-02