

DW80K7050 Series
DW80K5050 Series
DW80R5060 Series
DW80R5061 Series

Dishwasher installation guide



These installation instructions are intended for use by qualified installers.

If you are having problems installing this dishwasher
Please call : **1-800-SAMSUNG (726-7864)**
for assistance : www.samsung.com

imagine the possibilities

Thank you for purchasing this Samsung product.







SAMSUNG

safety instructions

Throughout this manual, you'll see Warning and Caution notes. These warnings, cautions, and the important safety instructions that follow do not cover all possible conditions and situations that may occur. It's your responsibility to use common sense, caution, and care when installing, maintaining, and operating the dishwasher. Samsung is not liable for damages resulting from improper use.

IMPORTANT SAFETY INSTRUCTIONS

What the icons and signs in this installation guide mean:

 WARNING	Hazards or unsafe practices that may result in severe personal injury or death .
 CAUTION	Hazards or unsafe practices that may result in personal injury or property damage .
 CAUTION	To reduce the risk of fire, explosion, electric shock, or personal injury when using the dishwasher, follow these basic safety precautions:
	Follow directions explicitly.
	Make sure the machine is grounded to prevent electric shock.
	Call the service center for help.

These warning signs are here to prevent injury to you and others.

Please follow them explicitly.

After reading this section, keep it in a safe place for future reference.

 Read all instructions before using the appliance.

Install and store the dishwasher inside, away from exposure to weather.

 Do not install the dishwasher near electrical components. Keep the dishwasher away from open flames.

Do NOT install the dishwasher on a carpet as this is a fire hazard.

Do NOT install the dishwasher in a location where the water may freeze (where the temperature falls below 32 °F [0 °C]). Frozen water in the hoses or pipes may damage the dishwasher.

As with all equipment using electricity, water and moving parts, potential hazards exist. To safely operate this appliance, become familiar with its operation and exercise care when using it.

 The dishwasher must be properly grounded. Never connect it to an ungrounded outlet.

Prior to removal of original dishwasher and the installation of your new unit, make sure to switch off your circuit breaker. Do not connect the dishwasher until you have completed the installation. Connecting the power cable is the last step when installing the dishwasher.

All wiring and grounding must be done in accordance with the electrical code applicable to the region.

GROUNDING INSTRUCTIONS

For a permanently connected appliance:

This appliance must be connected to grounded metal, a permanent wiring system, or an equipment-grounding conductor must be run with the circuit conductors and connected to the equipment-grounding terminal or lead on the appliance.

The dishwasher is very heavy. Do not attempt to move or carry a dishwasher alone. Two or more people are needed to move a dishwasher and avoid potential injuries.

 If the power cable is damaged, it must be replaced by the manufacturer, a service agent or similarly qualified person in order to avoid a hazard.

 Do not touch the power cable with wet hands.

 Do not connect another appliance to the same power outlet as the dishwasher.

Make sure to use a new water supply line. Old lines are susceptible to breakage because they become hardened and may cause property damage due to a water leakage.

The dishwasher must be connected to a hot water supply with a temperature between 120 °F (49 °C) – 149 °F (65 °C). This temperature range provides the best washing result and shortest cycle time. Temperature should not exceed 149 °F (65 °C) to prevent damage to dishes.

Ensure that the water supplied to the dishwasher does not freeze. Frozen water can damage the hoses, valves, pump, or other components.

Certified residential dishwashers are not intended for licensed food establishments. (NSF/ANSI Standard 184 for Residential Dishwashers)

For a full list of safety information, please refer to the User Manual.

BEFORE INSTALLING THE DISHWASHER



WARNING



Tip-Over Hazard

- Do not use the dishwasher until it is correctly installed.
- Do not push down on the door when it is open.
- Do not place excessive weight on the open door.



Electric Shock Hazard

Failure to follow these instructions can result in death, fire, or electric shock:

- Electrically ground the dishwasher
- Connect the ground wire to the green ground connector in the junction box.
- Do not use an extension cord.

To reduce the risk of electric shock, fire, or injury to persons, the installer must ensure that the dishwasher is completely enclosed at the time of installation.

contents

PREPARING THE DISHWASHER ENCLOSURE

- 5 Product dimensions
- 5 Enclosure dimensions

5

INSTALLING THE DISHWASHER

- 6 STEP 1 Check the parts and tools
- 8 STEP 2 Select the best location for the dishwasher
- 9 STEP 3 Check water supply requirements and cautions
- 10 STEP 4 Check the electrical requirements and cautions
- 11 STEP 5 Unpacking and inspecting the dishwasher
- 12 STEP 6 Preparing the dishwasher
- 14 STEP 7 Placing the dishwasher and connecting the hot water supply line
- 15 STEP 8 Leveling the dishwasher
- 16 STEP 9 Securing the dishwasher
- 17 STEP 10 Connecting the drain hose
- 20 STEP 11 Wiring connections
- 21 STEP 12 Completing the installation

6

SPECIFICATIONS

22

preparing the dishwasher enclosure

PRODUCT DIMENSIONS

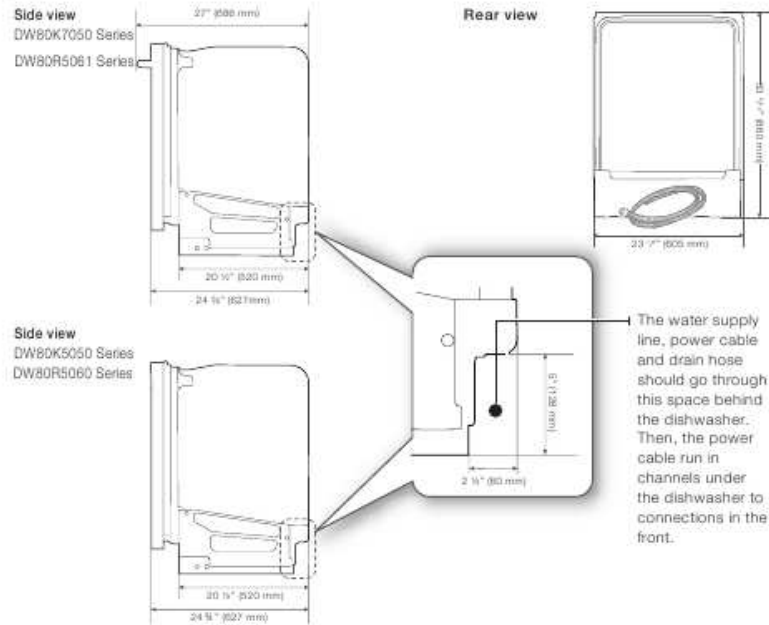

01 PREPARING THE DISHWASHER

ENCLOSURE DIMENSIONS

- This dishwasher is designed to be enclosed on the top and on both sides by a standard residential kitchen cabinet unit.
- The installation enclosure must be clean and free of any obstructions.
- The enclosure must be at least 24 inches wide, 24 inches deep, and 34 1/8 inches high.
- For the front door of the dishwasher to be flush with the leading edge of the counter top, the counter top must be at least 25 inches deep.

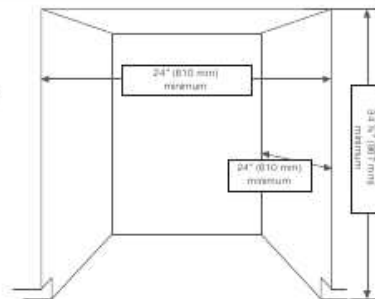

installing the dishwasher







Be sure that you or your installer follow these instructions closely so that the new dishwasher works properly and that you're not at risk of injury when washing dishes.

STEP 1 CHECK THE PARTS AND TOOLS











Before starting on the installation, prepare all the necessary tools and parts required to install the dishwasher. This will save installation time and simplify the installation process.

Parts required

Provided with the dishwasher. Check when you unbox the dishwasher in Step 5.

			
2 Installation Brackets	2 Flat Head Screws (For the installation bracket)	2 Screws (for the kick plate)	Kick Plate
			
Protective sticker	Nut connector & seal (for 1/2" 90° fitting)		

Not provided

			
2 Screws (for the side walls)	Twist on wire connector	Strain relief	Electrical tape & Standard duct tape
			
Hot water supply line	90° Fitting (1/2")	Tube fittings	Teflon® tape or sealing compound
			
Hose clamp	Air gap	Rubber connector	







 For the hot water supply line – We strongly recommend using 1/2" minimum O.D. copper tubing with a compression fitting or a flexible stainless steel braided hot water supply line.

[Warning: Do not use plastic tubing. Plastic tubing can deteriorate over time and cause a leak inside the tube fitting.]

You also need a 90° elbow with 1/2" N.P.T. external pipe threads on one end and a fitting sized to fit your hot water supply line (copper tubing/compression fitting or braided hose) on the other.

For the power cable, we recommend a jacketed 12-2 cable with ground. Note that some local codes may require the cable to have a BX style metal jacket.

Tools required

			
Electric drill	Safety glasses	Gloves	Flashlight
			
Adjustable wrench	Wire stripper	Pliers	Nipper
			
Tape measure	Pencil	Phillips screwdriver	Flat screwdriver
			
Tubing cutter	Cutting knife	Hole saw	Level
			
Torx T20	Hex L-wrench		

02 INSTALLING THE DISHWASHER

installing the dishwasher

New installation



If the dishwasher is a new installation, most of the installation work must be done before the dishwasher is moved into place.

Replacement

If the dishwasher is replacing an old dishwasher, you must check the existing dishwasher connections for compatibility with the new dishwasher. Replace the existing connections as necessary.

STEP 2 SELECT THE BEST LOCATION FOR THE DISHWASHER

The following criteria are important to ensure the best location for the dishwasher:

- The location must have a solid floor that is able to support the weight of the dishwasher.
- The location must be near a sink with easy access to the water supply, drain, and electrical outlet.
-  For the drain to operate properly, the dishwasher should be installed within 9.8 ft (3 m) of the sink.
- The location must let you load your dishes into the dishwasher easily.
- The location must have sufficient space for the dishwasher door to open easily and provide enough space between the dishwasher and the cabinet sides (at least 0.1 in (2 mm)).
-  If the dishwasher is installed in a corner, ensure that the side of the dishwasher is more than 2 in. (50 mm) from the wall or cabinet to its right or left.
- The wall at the back must be free of obstructions.

If this is a new installation, follow these steps:

1. Using a 2 1/2 inch hole saw, cut a hole into the side of the cabinet that holds the sink as shown in Figure 1-1 below.
 2. If the base inside the sink cabinet is raised above the kitchen floor and is higher than the connections on the dishwasher, make a hole in the base inside the cabinet and in the cabinet side as shown in Figure 1-2.
-  Depending on where your electrical outlet is, you may need to cut a hole in the opposite cabinet side.

<Figure 1-1>

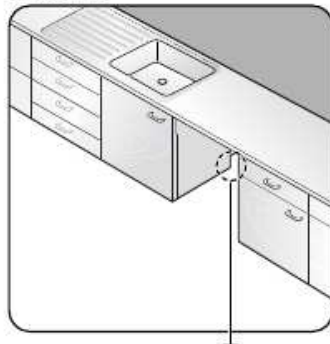

The hole for the water supply line, drain hose and power cables.

<Figure 1-2>

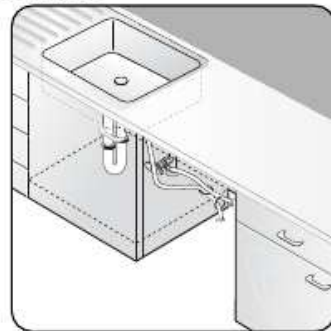

STEP 3 CHECK WATER SUPPLY REQUIREMENTS AND CAUTIONS

- The hot water supply line pressure must be between 20–120 psi (140–830 kPa).
- Adjust the water heater to deliver water between 120 °F (49 °C) – 149 °F (65 °C).
 - The dishwasher must be connected to a hot water supply between 120 °F (49 °C) – 149 °F (65 °C). This temperature range provides the best washing result and shortest cycle time. Temperature should not exceed 149 °F (65 °C) to prevent damage to dishes.
 - Ensure that the water supply valve is turned off before connecting the hot water supply line to the dishwasher.
 - Seal the hot water supply line connections using teflon tape or sealing compound to stop any water leakage.
 - The drain hose connected to the dishwasher must be run through the hole in the side wall so it can be connected to the drain outlet of the sink. When you install the dishwasher, ensure there is nothing on the drain hose and be careful not to tear it during the installation process.

<Figure 2>

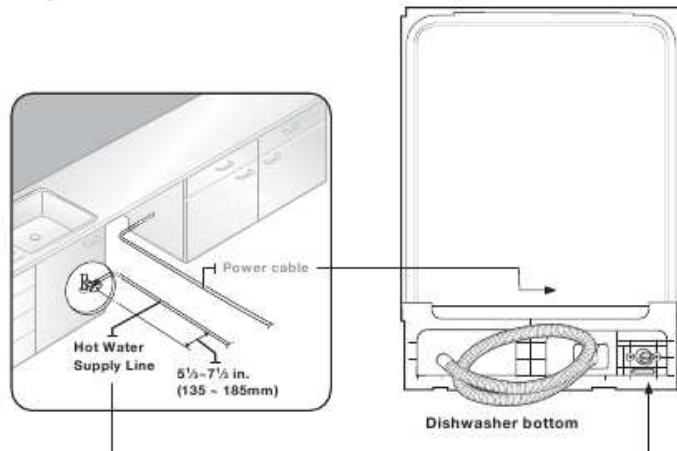

installing the dishwasher

STEP 4 CHECK THE ELECTRICAL REQUIREMENTS AND CAUTIONS

The electrical requirements for the dishwasher are as follows:

- In the United States, install in accordance with the National Electric Code/State and Municipal codes and/or local codes.
- In Canada, install in accordance with the Canadian Electric Code C22.1-latest edition/Provincial and Municipal codes and/or local codes.
- For cable direct connections.
 - Use flexible, armored or non-metallic sheathed, copper wire with a grounding wire that meets the wiring requirements for your local codes and ordinances.
 - Use the strain relief method provided with the wiring junction box or install a U.L.-listed/CSA-certified clamp connector to the wiring junction box. If using conduit, use a U.L.-listed/CSA-certified conduit connector.
- For power cord connections
 - The power supply cord must plug into a mating three prong, grounded outlet, located in the cabinet next to the dishwasher opening. The outlet must meet your local codes and ordinances. Use a U.L.-listed/CSA-certified power cord kit.
 - The dishwasher must be connected to an electrical supply that provides the voltage and amperage marked on the rating plate of the unit: 15 amps, 120 volts, 60Hz AC.
 - Ensure that the circuit breaker connected to the dishwasher is off.
 - The power cable must not extend more than 4 ft (1.2 m) from the side of the dishwasher.
 - Check with a qualified electrician or serviceman if you are unsure whether the dishwasher is properly connected.
 - Do not connect another appliance to the same power outlet as the dishwasher.
 - Before connecting the power cable to the dishwasher, ensure that there are no electrical hazards (which may result in fire, explosion, electric shock, or personal injury).
 - The power cable must pass through the channel on the bottom of the dishwasher as shown in Figure 3.

<Figure 3>

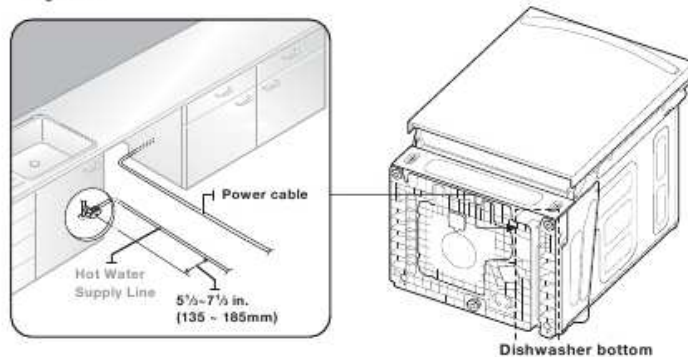

STEP 5 UNPACKING AND INSPECTING THE DISHWASHER

Unbox the dishwasher in an open area free of obstruction both around the carton and overhead. We recommend that you retain the carton and all of the packing materials until the dishwasher is fully installed and operational to ensure you have removed all the product's components from the carton prior to disposal.

Unboxing

1. Position the carton right-side-up with top arrows pointing upwards.
2. Unbuckle or cut the four straps securing the carton top.
3. Lift the top of the telescoping carton clear of the carton tray and the contents, and then turn it over and place it on the floor.
4. Put the straps and all of the packing materials from around the dishwasher inside the carton top, inspecting them for any signs of damage.
5. Gently pull the kick plate down to remove and keep it for use in step 12 later.
The kick plate is attached to the right side of the dishwasher.
⚠ The upper side of the kick plate is put inside the felt.
To prevent the kick plate from being bent, use caution to remove.

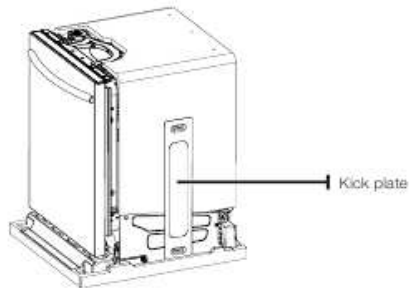

6. Lift the dishwasher from the carton tray, and then place it on the floor.
Put the tray into the carton top.
7. Remove the bag that protects the dishwasher during shipping.
CAUTION ALWAYS LIFT THE Dishwasher TO MOVE IT. Sliding it over rough surfaces can damage the dishwasher's feet and sliding the feet over finished surfaces can, in some cases, damage that finish or the underlying surface.
8. There is also packing inside the dishwasher that you may want to leave in place until the dishwasher is installed.
9. **DO NOT**, under any circumstances, remove the sound-absorbent padding that surrounds the exterior of the tub of the dishwasher.

Inspecting

Mechanical

1. Check the plastic base assembly to ensure that it is intact.
2. Check the dishwasher's feet to ensure they are in place and can be adjusted so you can level and secure the dishwasher.
3. Check all the visible components on the bottom of the dishwasher to ensure they are intact and secure.
4. Check the door latch, the operation of the hinges, and confirm the door is properly secured to the dishwasher.

installing the dishwasher

Plumbing

1. Check the hot water connection on the front left-side of the base of the dishwasher. The mounting plate should be secured to the front of the base, the threads inside the connection should be smooth and shiny, and the area should be clean and free of any debris.
2. Check the plastic Brake and Sensor cases to ensure these assemblies are not cracked and that all connections are secure.
3. Check the drain hose for any holes or deformities that could allow a water leak during draining.

Electrical

1. Confirm the junction box cover is secured to the junction box on the front right-side of the base of the dishwasher.
2. Confirm the electrical box was not damaged during shipping and that it is secured to the base of the dishwasher.

Appearance



1. Confirm there are no dents or scratches on the front of the dishwasher.
2. Check the edges of the doors for any roughness or cracking.
3. Check the control panel to ensure it is clear and unscratched, and that all the control markers are in their proper places.

Parts

1. Confirm you have all the parts listed in Step 1 on page 6.

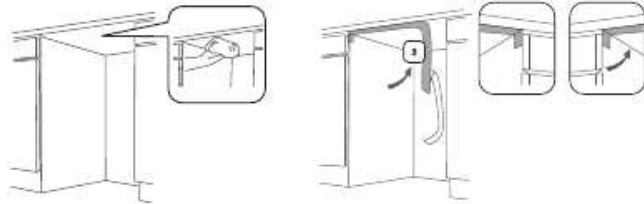
STEP 6 PREPARING THE DISHWASHER



1. Install the Protective sticker ③.
 Attach the Protective sticker to the bottom of the counter top as shown in the picture.
2. Ensure that the circuit breaker and water supply valve are turned off before proceeding with the following steps.
 Before you move or lay down the dishwasher for installation, make sure to adjust the height of the legs so the legs are as short as possible. This prevents the legs from breaking. Level the dishwasher by adjusting the height of the legs after you have the dishwasher in place.
3. Use the provided nut connector to connect the water hose to the dishwasher. Follow these steps:

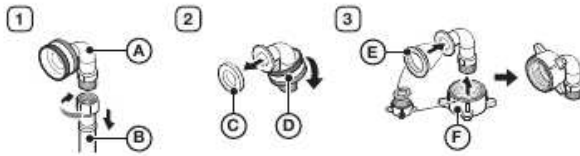

- 1) Disconnect the 90° fitting (A) from the hose (B).
 - 2) Remove the seal (C) and the nut (D) from the 90° fitting.
 - 3) From the provided nut connector, separate the seal (E) and the nut (F), and then assemble them to the 90° fitting as shown in the figure. You must insert the smaller side of the seal.
4. Then, insert the 3/4" 90 degree fitting into the inlet valve (see Figure 4-B). Tighten until the 3/4" fitting is tight. Do not over tighten.
 5. Make sure there are no kinks and that the hose is not bent at any extreme angles that could constrict the flow of water.
 6. Remove the junction box cover located at the bottom front right of the dishwasher using a screwdriver, and then install the strain relief (Figure 4 - C). Make sure to keep the junction-box cover you removed. It is used in Step 11, Wiring Connections.
 7. If the countertop is made of wood or a material that is not damaged by drilling, attach the two (2) Installation brackets that were supplied with the dishwasher using the supplied screws (Figure 4 - A). They will be used in Step 9, Securing the Dishwasher.

<Figure 4>

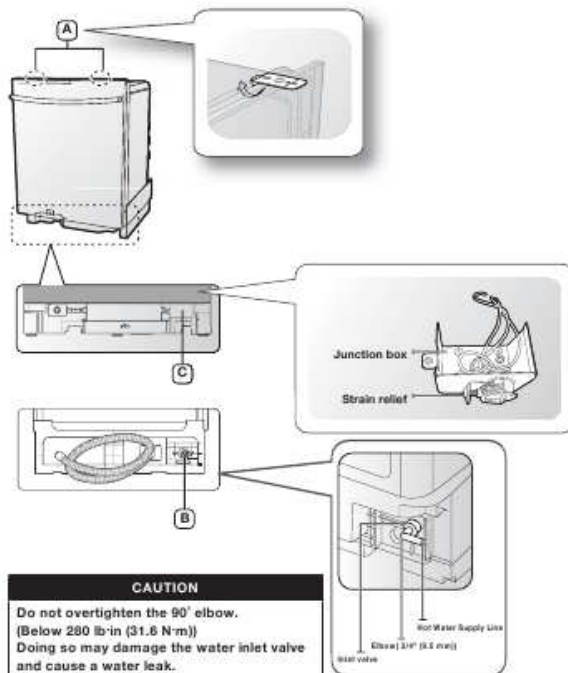

installing the dishwasher

STEP 7 PLACING THE DISHWASHER AND CONNECTING THE HOT WATER SUPPLY LINE

1. Adjust the three leveling legs at the bottom of the dishwasher after measuring the height of the cabinet opening from under the countertop to the floor. (See Step 8, Leveling the Dishwasher.)
2. Locate the hot water supply line and the power cable.
3. Place the dishwasher so that the power cable is in the right channel of the base of the dishwasher. Use standard duct tape or cable ties to secure the electrical cable to their adjacent channels in the base. This can prevent the electrical cable from being squeezed when you push the the dishwasher into place.
4. Pull the drain hose through the hole in the sink cabinet side wall. Keep it free of kinks.
5. Make sure the hot water supply line is not twisted, and then connect the hot water supply line to the elbow joint.
6. Slide the dishwasher carefully into the installation space. If possible, gently pull any excess lengths of water supply line, drain hose, or power cable back as you move the dishwasher. Get a second or third person to help you do this if necessary.

 Do not place the dishwasher on the water supply line, drain hose, or power cable. Also, make sure they are not folded or twisted.

<Figure 6>

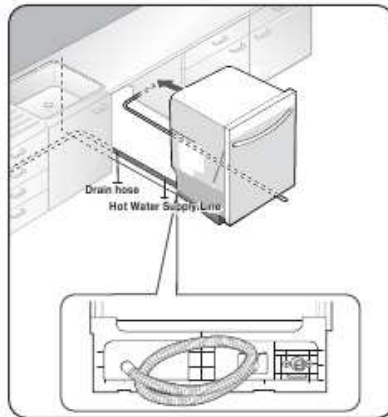

<Figure 7>

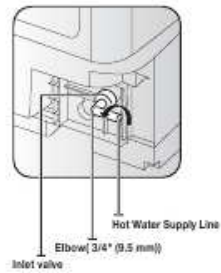

CAUTION
Do not overtighten the 90° Fitting.
(Below 260 lb·in (31.6 N·m))
Doing so may damage the water inlet
valve and cause a water leak.

STEP 8 LEVELING THE DISHWASHER

1. Open the door and place the level against the top of the tub on the inside and check if the dishwasher is level. If it is not level, rotate the leveling legs at the bottom front of the dishwasher until the dishwasher is level. See the first note below for instructions on adjusting the height of the front legs.

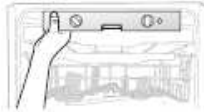

2. Use the level to check if the dishwasher is level front to back, as shown in the figure to the right. If the dishwasher is not level front to back, adjust the height of the rear leg until the dishwasher is level. See the second note below for instructions on adjusting the rear leg.

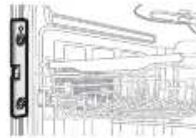

3. Open the door of the dishwasher and check if both the tub and door clearances are correct. If not, rotate the leveling legs on the bottom front of the dishwasher. You can also check this by placing a level against an inside front vertical surface of the tub.



- ⚠ If the leveling legs are rotated to the right (counter clockwise), they are loosened and the front of the dishwasher is raised. If they are rotated to the left (clockwise), they are tightened and the front of the dishwasher is lowered.



- ⚠ To adjust the height of a rear leg, turn the Hexbolt (at the front of the base) to the left to raise the back of the dishwasher using the proper tool (Hex L-wrench or similar tool).

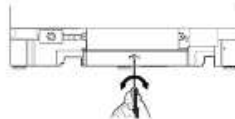

- ⚠ Before you move the dishwasher for installation, make sure to adjust the height of the legs so the legs are as short as possible. This prevents the legs from breaking. Level the dishwasher by adjusting the height of the legs after you have the dishwasher in place.

- ⚠ The dishwasher can leak if it's tilted by more than 1 degree.

installing the dishwasher

STEP 9 SECURING THE DISHWASHER

You must fix the dishwasher to the countertop or cabinet side walls for additional stability and safety.

1. If the countertop is made of wood or the material will not be damaged by drilling, follow the instructions in **2-1** below.
If the countertop is made of granite, marble, or any other material that can be damaged by drilling, follow the instructions in **2-2** below.
 - 2-1. If the installation brackets on the front of the dishwasher extend cut them down using a nipper as shown in Figure 8 on the next page.
Put a large towel into the bottom of the dishwasher to prevent wood shavings or a dropped screw from falling into the dishwasher.
Carefully drill screw holes into the counter top bottom by passing the drill bit through a screw hole in each bracket, and then drilling into the counter top bottom beneath.
Make sure the hole you drill is smaller than the diameter of the screw.
Insert the provided screws into the brackets, and then tighten to secure the dishwasher to the counter top.
 - 2-2. Put a large towel into the bottom of the dishwasher to prevent wood shavings or a dropped screw from falling into the dishwasher. Remove the tub spacer caps with the tip of a screwdriver. The caps are just inside the tub near the top of the tub on both sides (Figure 9 on the next page).
Drill a hole into the sides of the kitchen cabinet on both sides by carefully passing a drill bit through the screw holes exposed by the removal of the spacer caps, and then drilling into the cabinet side beneath.
Make sure the hole you drill is smaller than the diameter of the screw.
Also make sure the drill bit does not strike the sides of the spacer cap holes. Insert the provided screws into the holes, and then tighten to secure the dishwasher to the cabinet. Make sure the tub is not distorted by pressure from the screws.
If the tub is distorted, loosen the screws a little.
Replace the tub spacer caps.
-  The screws or tub spacer cap may fall into the dishwasher while you are working with the door open. Cover the interior of the dishwasher with a towel to prevent any screws from falling into the dishwasher. If any foreign items such as a screw get into the dishwasher, it may cause noise, an abnormal operation, damage, or a malfunction.
 - Use a magnetic screwdriver to help prevent screws from falling into the dishwasher.
 - If a foreign item such as a screw gets into the dishwasher and you are unable to remove it, the dishwasher needs to be disassembled. Contact a qualified service technician for this.

<Figure 8>

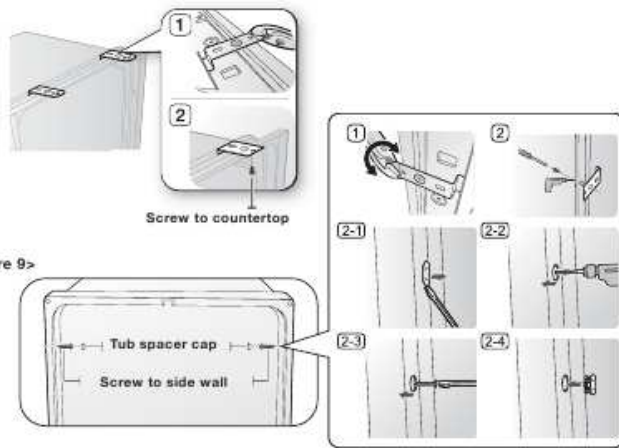

STEP 10 CONNECTING THE DRAIN HOSE

1. Check the parts on the sink to which the drain hose will be connected;
2. There are several ways to insert the drain hose into the drain hose connector of the sink, as shown in the following figures. You must connect the drain hose in accordance with the water pipe installation regulations in your region.

<Figure 10>

Case 1. Without disposal

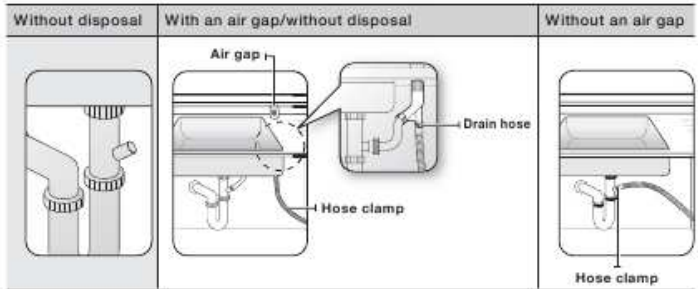

installing the dishwasher

Case 2. With disposal

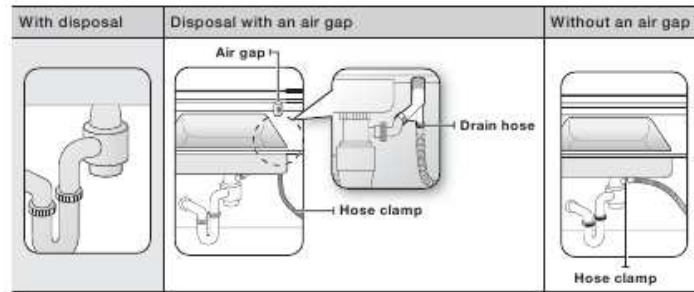

3. Check the size of the sink's drain hose connector. If needed, cut the drain hose so its end fits onto the sink connector (1" or 5/8" - as shown in Figure 11 below). If the end of the drain hose does not fit onto the drain hose connector of the sink, use an adaptor purchasable at a plumbing/hardware supply store.
 4. Slide a hose clamp over the end of the drain hose. Attach the drain hose to the sink connector, slide the hose clamp to the end of the hose, and then tighten the hose clamp.
Note : You must use a hose clamp. Failure to do so may cause water leakage.
 5. If there is no air gap, make sure to hang the middle of the drain hose well above the sink cabinet base to prevent backflow (see Figure 13 on the next page).
 6. When drilling a hole for the drain hose on the cabinet wall, take caution not to damage the drain hose by sharp edges of the hole. On wooden walls, use sand paper to soften the edges. On metal walls, use insulation tape or duct tape to cover the sharp edges around the hole.
 7. Take caution not to damage the drain hose when installing the dishwasher on the floor, wall, or cabinet.
-  To prevent leaks or drainage problems, make sure the drain hose is not damaged, kinked, or twisted.
 - 8. Do not cut the wrinkled area of the drain hose to fit the size. When arranging the drain hose, take caution not to contact on sharp edges of the cabinet or under-sink.
- CAUTION**
- Be careful when cutting off the end of the drain hose as there is a risk of injury. Clean around the sink's drain connection so that it does not damage the hose. Check for any foreign items in the drain hose and remove them.
 - When arranging the drain hose, make sure the drain hose is not cut, torn, or broken by any sharp edges of the floor, the product itself, or the cabinet. A damaged drain hose causes a leak.

<Figure 11>

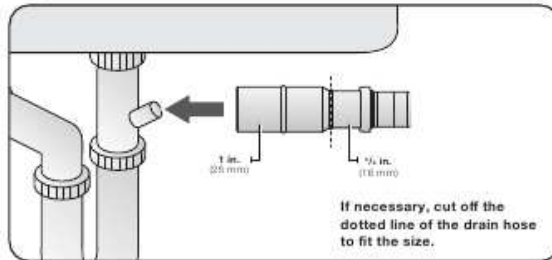

<Figure 12>

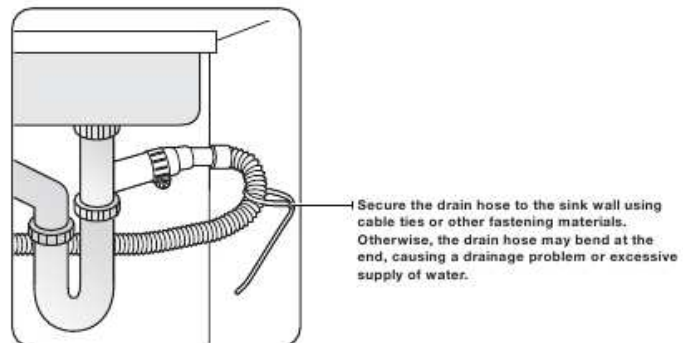

<Figure 13>

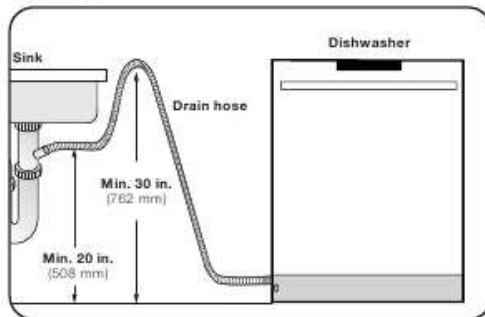

installing the dishwasher

STEP 11 WIRING CONNECTIONS

1. Before connecting the power cable to the dishwasher, make sure the circuit breaker is off.
2. In the junction box located at the front bottom right of the dishwasher, find the three power wires from the dishwasher including the grounding line.
3. Pass the power cable through the strain relief, and then into the junction box (Figure 14).
4. Connect the black wire of the dishwasher to the black wire of the power cable by inserting both into a wire nut and then rotating the wire connector as shown in Figure 15. Connect the white wire to the white wire and the green to the green in the same manner. Each colored wire should be connected to the corresponding wire of the same color. White should be connected to white, black to black, and green to green.
5. Recheck each wire to ensure it is connected correctly and securely.
6. Replace the junction box cover on the dishwasher.

<Figure 14>

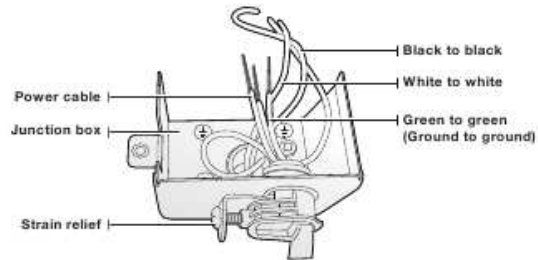

<Figure 15>

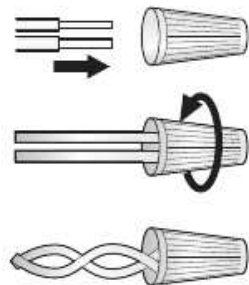

WARNING Electrical Shock Hazard To avoid electrical shock, do not work on an energized circuit. Doing so could result in serious injury or death. Only qualified electricians should perform electrical work. Do not attempt any work on the dishwasher electric supply circuit until you are certain the circuit is de-energized.
WARNING Fire Hazard To avoid a fire hazard, make sure electrical work is properly installed. Only qualified electricians should perform electrical work.

-  Recheck each wire to ensure it is connected correctly and securely. Each colored wire should be connected to the corresponding wire of the same color.

STEP 12 COMPLETING THE INSTALLATION

1. Open the door and remove all foam, paper packaging, and unnecessary parts.
2. Turn on the circuit breaker you turned off before you began the installation.
3. Open the water supply valve to supply water to the dishwasher.
4. Turn on the dishwasher, and then select and run a cycle.

 Check if the power turns on correctly and if there is any water leakage while the dishwasher is operating. If no errors occur while it is operating, turn off the dishwasher, and then go to Step 5 below.

If an error has occurred, turn off the dishwasher, close the water supply valve, and then refer to the user manual or contact a service center 1-800-SAMSUNG (726-7864).

 **CAUTION** Make sure to check for water leakage on both ends of the water supply line and drain hose connector.

5. Confirm that the kick plate gasket is on the bottom of the kick plate. Insert the rubber skirt behind the kick plate, and tighten the kick plate using the screws included in the Install Kit. See the figures below for reference.

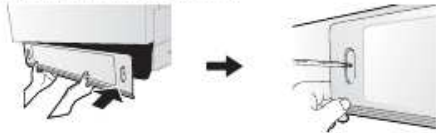

specifications

Power supply	120 V, 60 Hz AC only
Water pressure	20 – 120 psi (140 – 830 kPa)
Dimensions (WidthxDepthxHeight)	23 7/8 x 24 1/4 (Excluding Handle) x 33 3/8 in. (605 x 627 (Excluding Handle) x 860mm) (DW80K7050 Series,DW80R5061 Series) 23 7/8 x 24 1/4 x 33 7/8 in. (605 x 627 x 860 mm) (DW80K5050 Series,DW80R5060 Series)
Nominal inlet water temperature	120 F (49 °C)

 Specifications are subject to change without notice for quality improvement purposes.
The actual appearance of the dishwasher may differ from the illustrations in this manual.

notes

SAMSUNG

DD81-02034D-00