

Dishwasher

Installation manual

DW60R2014US/DW60R2014AP

SAMSUNG

Contents

Installation	3
What's included	3
Installation requirements	6
Dimensions and specifications	8
Step-by-step installation	10

Installation

Follow these instructions carefully to ensure proper installation of the dishwasher and to prevent accidents when washing dishes.











What's included

Make sure all the parts are included in the product package. If you have a question about the dishwasher or the parts, contact a local Samsung customer center or your retailer. The actual appearance of the dishwasher may differ, depending on your model and country.

⚠ CAUTION

After unpacking the dishwasher, keep the packaging materials out of children's reach to ensure their safety.

DW60R2014AP

 Top brackets (2 ea)	 Ø4 X 14 screws (10 ea)	 Sub foot (3 ea)	 Custom panel fixers (wood panel holders, 2 ea)
 Ø3.5 X 45 screws (4 ea)	 Ø3.5 X 25 screws (2 ea)	 Ø3.5 X 16 screws (2 ea)	 Nut connector & seal (for 90° fitting)
 Plastic caps (2 ea)	 Door bracket (2 ea)		

Installation

Installation

DW60R2014US



Top brackets (2 ea)



Ø4 X 14 screws
(2 ea)



Sub foot (3 ea)



Ø3.5 X 16 screws
(2 ea)



Kick plate brackets
(2 ea)



Kick plate



Nut connector &
seal (for 90° fitting)



Plastic caps (2 ea)

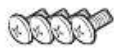

Kick plate bolt
(4 ea)



Kick plate nut
(4 ea)

Installation kit (not provided)



Electrical tape &
Standard duct tape



Hot water line



90° Fitting (¼")



Tube fittings



Hose clamp



Air gap



Rubber connector



Teflon tape or
sealing compound



















⚠ WARNING

Do not use plastic tubing. Plastic tubing can deteriorate over time and cause a leak inside the tube fitting.

NOTE

- For the hot water line, we strongly recommend using 3/4" minimum O.D. copper tubing with a compression fitting or a flexible stainless steel braided hot water supply line.
- You also need a 90° Fitting with 3/4" N.P.T. external pipe threads on one end and a fitting sized to fit your hot water line (copper tubing/compression fitting or braided hose) on the other.
- For the power cable, we recommend a jacketed grounded 12-2 cable. Note that some local codes may require the cable to have a BX style metal jacket.

Tools required (not provided)

			
Electric drill	Safety glasses	Gloves	Flashlight
			
Adjustable wrench	Torx T15	Pliers	Nipper
			
Tape measure	Pencil	Phillips screwdriver	Flat head screwdriver
			
Tubing cutter	Cutting knife	Level	Hole saw
			
Hex L-wrench	Vernier calipers	Steel ruler	

Installation

Installation requirements

To prevent a risk of fire, electric shock, or personal injury, all wiring and grounding must be done by a qualified technician.

Power supply

- To prevent the risk of fire, electric shock, or personal injury, all wiring and grounding must be performed in accordance with the National Electrical Code ANSI/FNPA, No. 70 Latest Revision and local codes and ordinances. It is the personal responsibility of the appliance owner to provide adequate electrical service for this appliance.
- When preparing for installation, make sure that your power supply provides an individual 120 Volt, 60 Hz branch circuit serving only your dishwasher with a 15 AMP fuse or circuit breaker.
- Your dishwasher must be grounded. If your dishwasher malfunctions or breaks down, grounding will reduce the risk of electric shock by providing a path of least resistance for the electric current.

⚠ WARNING

- Do not use an extension cord.
- Use only the power plug that comes with the dishwasher.

Grounding

For permanent grounding, the dishwasher must be properly grounded to a grounded metal or permanent wiring system. The grounding conductor must be run with the circuit conductors and then connected to the grounding terminal or lead on the dishwasher.

⚠ WARNING

- Do not connect the ground wire to plastic plumbing, gas lines, or hot water pipes. Improperly connected grounding conductors may cause electric shock.
- Do not modify the power plug of the dishwasher. If the power plug does not fit the outlet, have a proper outlet installed by a qualified electrician.

Water supply

- The hot water supply line must support water pressures between 20 psi and 120 psi (140-830 kPa).
- Water temperatures must be between 120 °F (49 °C) and 149 °F (65 °C).

To reduce a risk of leaks:

- Make sure water taps are easily accessible.
- Turn the water tap off when the dishwasher is not in use.
- Check for any leaks at the water hose fittings on a regular basis.

Flooring

For safety, the dishwasher must be installed on a solidly constructed floor. Wooden floors may need to be reinforced to minimize vibrations. Avoid installing on carpet or soft tile. Carpeting and soft tile may cause vibrations and may cause your dishwasher to move slightly while operating.

WARNING

Do not install the dishwasher on a poorly supported structure.

Installation

Dimensions and specifications

Dishwasher

DW60R2014US Series (Built Under model)

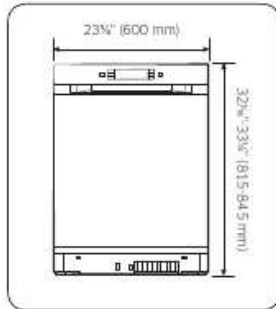

Front view

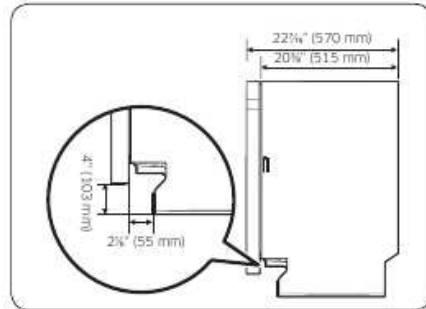

Side view

DW60R2014AP Series (Fully Built In model)

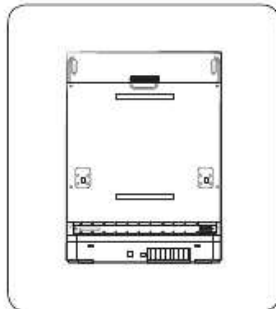

Front view

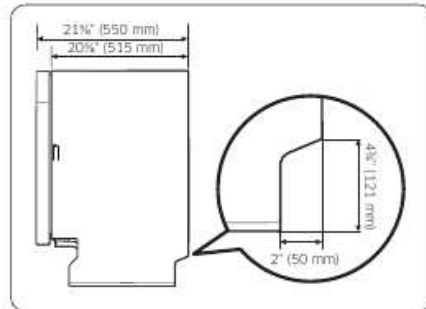

Side view

Cabinet

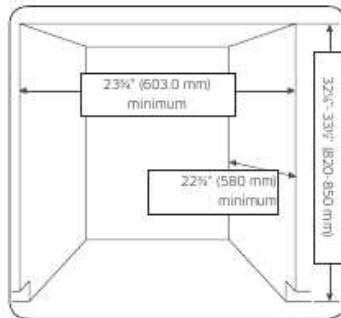

- This dishwasher is designed to be enclosed on the top and on both sides by a standard, residential kitchen cabinet.
- The installation enclosure must be clean and free of any obstructions.
- The enclosure must be at least 23 3/4" wide, 22 1/4" deep, and 32 1/4" high.
- For the front door of the dishwasher to be flush with the leading edge of the countertop, the countertop must be at least 2 3/8" deep.

Specifications

Specifications are subject to change without notice for improved quality. The actual appearance of the dishwasher may differ from the illustrations in this manual.

Power supply	120 V, 15 A, 60 Hz AC
Water pressure	20-120 psi (140-830 kPa)
Dimensions (Width x Depth x Height)	DW60R2014US : 23 3/4" x 22 1/4" x 32 1/4" in. (600 x 570 x 815 mm) DW60R2014AP : 23 3/4" x 21 1/4" x 32 1/4" in. (600 x 550 x 815 mm)
Minimum inlet water temperature	120 °F (49 °C)

Installation

Installation

Step-by-step installation

The installation procedure may differ depending on the model.

STEP 1 Select a location

Select a location that meets the following conditions.

- The location must have a solid floor that can support the weight of the dishwasher.
- The location must be near a sink (9.8 ft/3 m) with easy access to the water supply, drain system, and electrical outlet.
- The location must let you load dishes into the dishwasher easily.
- The location must have sufficient space for the dishwasher door to open easily and provide enough space between the dishwasher and the cabinet sides (at least 0.1 inch/2 mm).
- The rear wall must be free of obstructions.

Installation in a new location

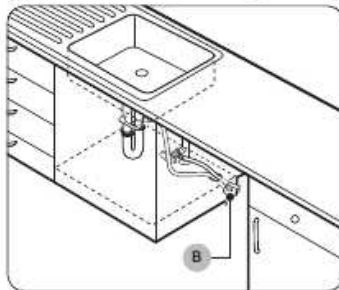
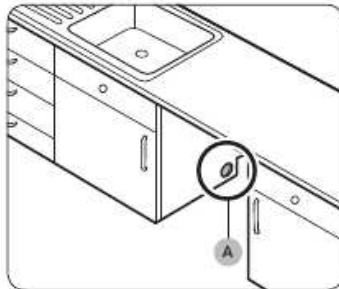

If you install the dishwasher in a new location, follow these instructions before installing the dishwasher.

1. Using a hole saw, cut a hole into the side of the cabinet that holds the sink (A).
2. If the base inside the sink cabinet is raised above the kitchen floor and is higher than the connections on the dishwasher, make a hole in the base inside the cabinet and in the cabinet side (B).

NOTE

- If you are replacing an old dishwasher, check the existing connections for compatibility with the new dishwasher and replace the connections as needed.
- You may need to cut a hole in the opposite side of the cabinet according to the location of the electrical outlet.

STEP 2 Connect the hot water line

- The water line pressure must be between 20 psi and 120 psi (140-830 kPa).
- Make sure that the water temperature is delivered between 120 °F and 149 °F (49-60 °C). Exceeding this limit may cause the dishwasher to malfunction.
- Make sure that the circuit breaker and water valve is turned off before connecting the water supply line to the dishwasher.
- Make sure the water line is properly connected. Wrap Teflon tape around every connection and joint to prevent water leaks.

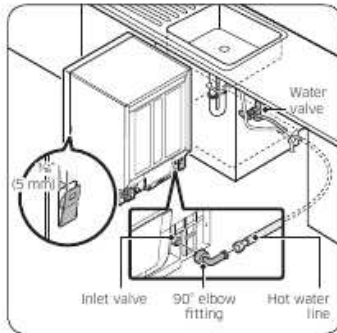
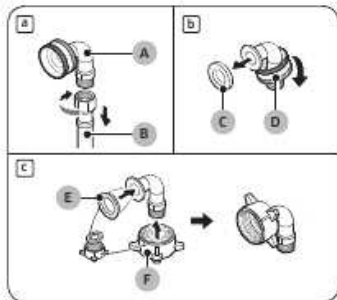

1. Use the provided nut connector to connect the water hose to the dishwasher.
Follow these steps:
 - a. Disconnect the 90° fitting (A) from the hose (B).
 - b. Remove the seal (C) and the nut (D) from the 90° fitting.
 - c. From the provided nut connector, separate the seal (E) and the nut (F), and then assemble them to the 90° fitting as shown in the figure. You must insert the smaller side of the seal.
2. Insert the 3/4" 90-degree fitting into the inlet valve. Tighten the fitting until it points towards the water-hose channel in the base of the dishwasher. Do not overtighten.
3. Connect the hot water line to the fitting.
4. If you want to secure the dishwasher to the side wall for extra stability, bend the brackets of the left and right housings by referring to the figure.

Installation

STEP 3 Arrange the hoses

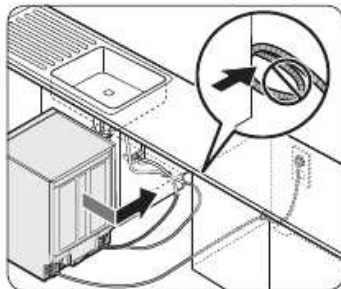

1. Arrange the power cable and the drain hose so that they move together.
2. Gently move the dishwasher to the installation space under the sink. While moving the dishwasher, pull any excess portions of the water line, drain hose, and power cable into the space.

NOTE

For DW60R2014US models, go to STEP 6.

CAUTION

- Use caution not to kink or step on the power plug or the hoses.
- Location of the outlet can not be placed behind the dishwasher.

STEP 4 Install the custom panel (FBI models only (DW60R2014AP))

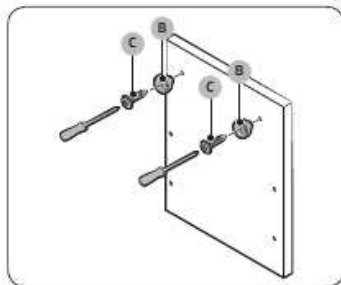
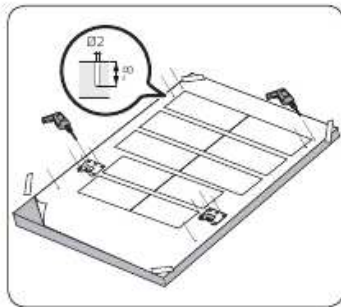

1. Put the installation template on the back of the custom panel and fix it temporarily using transparent tape. Note that the rear of the custom panel will be attached to the dishwasher door.

⚠ CAUTION

- The top end of the custom panel must be aligned with the top end of the installation template.
 - Use a custom panel between 7 lbs and 18 lbs.
2. Pre-drill the 14 points marked on the installation template using a 2- ϕ drill bit to a depth of ~8 mm.
 3. Remove the installation template and tighten the custom panel fixers (B) at the top with 2 screws (C, $\phi 3.5 \times 25$) as shown.

Installation

Installation

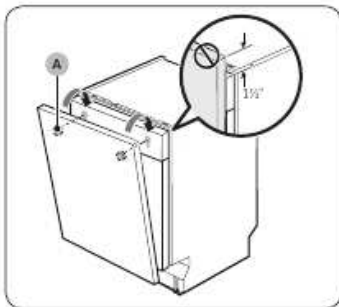

4. While holding the custom panel, attach it to the door and insert the **custom panel fixers (A)** into the corresponding holes at the top of the door as shown.
5. Push the custom panel downward to fix.

⚠ CAUTION

Do not let the custom panel extend more than 1 1/2" from the top of the dishwasher.

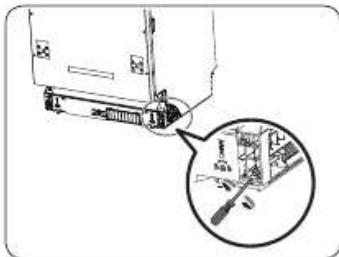

6. Adjust the spring level while the door is approximately opened at 30 degrees. The door should hold its position, and should not fall open.

⚠ CAUTION

- Do not adjust the spring level while the door is completely opened.
- If the custom panel weighs more than 18 lbs (8 kg), the door may fall open. Custom panels weighing more than 18 lbs (8 kg) are not recommended.

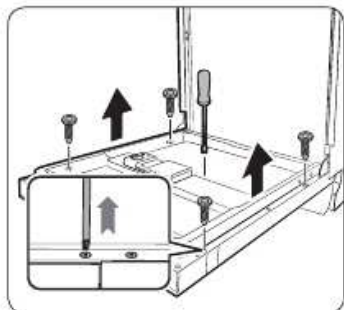

7. Open the dishwasher door and remove the 4 screws using the Torx T15 screwdriver.

⚠ CAUTION

Use caution when opening the door. The door might open or close unexpectedly if the spring level is not adjusted appropriately, resulting in physical injury.

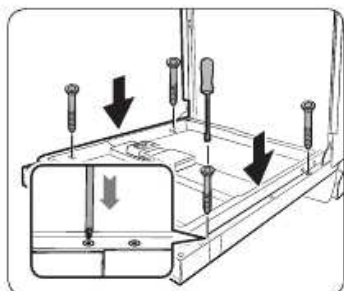

8. Secure the custom panel to the door by fastening the 4 screws (Ø3.5 X 45) using the Torx T15 screwdriver.

Installation

STEP 5 Level the dishwasher

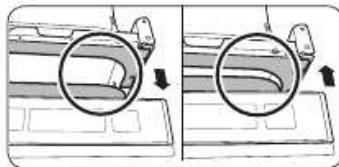
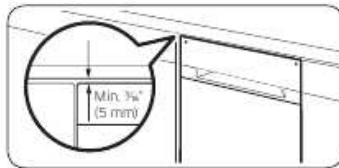
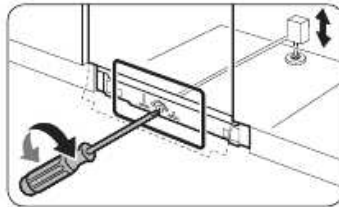
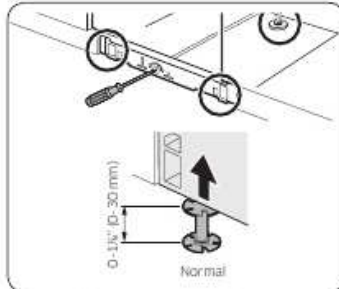

You can adjust the height of the dishwasher to level it. Note that in these steps, the dishwasher is currently inserted halfway.

1. Use the level to check if the dishwasher is level.
2. When adjusting the front height, use the regular foot for heights lower than 1 1/2".
 - To lower the height, turn the foot clockwise.
 - To raise the height, turn the foot counter clockwise.
3. To adjust the rear height, insert the screwdriver in the bottom center of the dishwasher.
 - To lower the height, turn the screwdriver clockwise.
 - To raise the height, turn the screwdriver counter clockwise.
4. Leave at least a 3/16" space between the top of the dishwasher and the bottom of the countertop.
5. When levelling is complete, check if the door opens and closes properly.

STEP 6 Secure the dishwasher

Correct positioning

Before securing the dishwasher, make sure the dishwasher is positioned in the center.

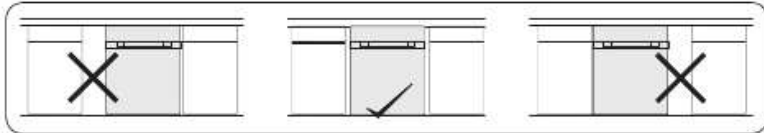

To the countertop

You can use the brackets to secure the dishwasher to the countertop. Alternatively, you can drill the side holes to secure the dishwasher to the cabinet sides.

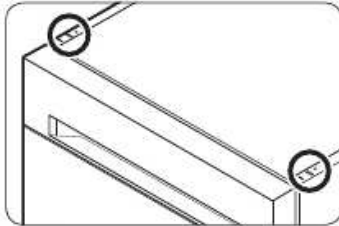

1. Put a large towel on the bottom of the dishwasher (covering the sump) to prevent wood shavings or screws from falling into the dishwasher sump.
2. Insert the provided brackets into the top front holes of the dishwasher as shown.
3. Insert the dishwasher fully into place under the countertop.

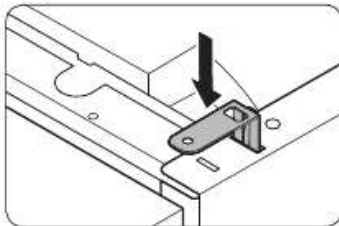

4. Carefully drill 2 screw holes into the bottom of the countertop from beneath, one for each countertop bracket.
 - Make sure the hole you drill is smaller than the diameter of the screw.
5. Insert the provided screws into the hole of brackets, and then tighten to secure the dishwasher to the countertop.

NOTE

Use a magnetic screwdriver to help prevent screws from falling into the dishwasher.

Installation

Installation

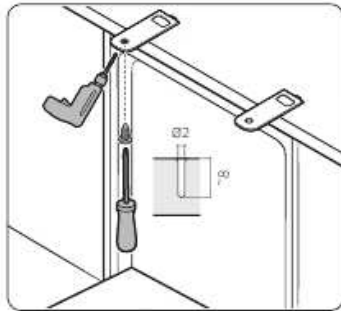

6. Insert the provided screws into the brackets, and then tighten to secure the dishwasher to the countertop.

NOTE

Use a magnetic screwdriver to help prevent screws from falling into the dishwasher.

7. Connect the water hose, but do not open the water tap until installation is complete.

To the side walls

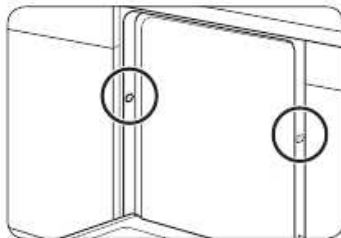

1. Put a large towel on the bottom of the dishwasher (covering the sump) to prevent wood shavings or screws from falling into the dishwasher sump.

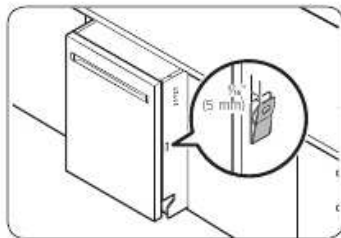

2. To prevent damage to the drain hose through the water supply line, slightly pull out the dishwasher and bend the built-in ear brackets of the left and right housings by $\frac{3}{16}$ " (5 mm). When done, reinsert the dishwasher with its center aligned.

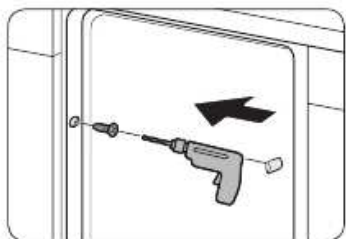

3. Drill one hole into both sides of the kitchen cabinet, totaling 2 screw holes.
 - Make sure the hole you drill is smaller than the diameter of the screw.
 - Make sure the drill bit does not strike the sides of the spacer cap holes.
4. Tighten the provided screws into the holes to secure the dishwasher to the cabinet.
5. Insert the provided plastic caps to the 2 places where screws are fastened.

Installation

Installation

STEP 7 Connect the drain hose

There are several ways to insert the drain hose into the drain hose connector of the sink. You must connect the drain hose in accordance with the water pipe installation regulations in your region.

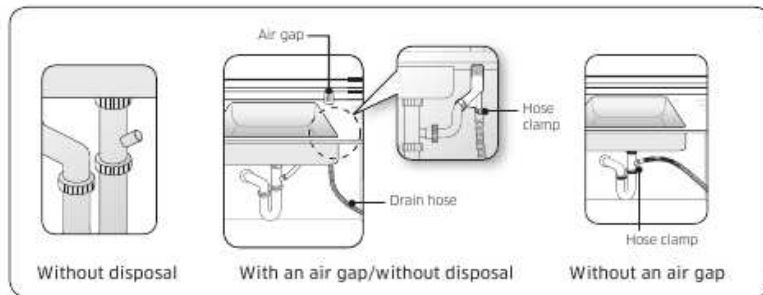

Drain system with no waste-disposal

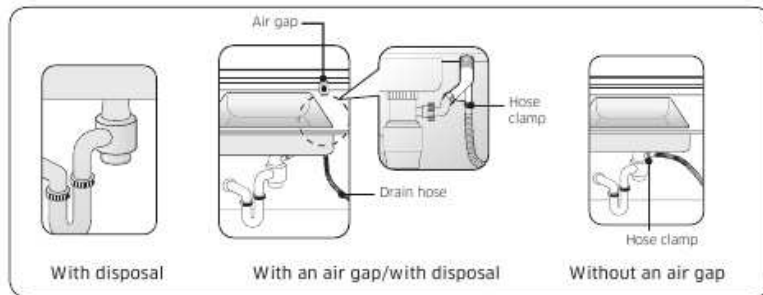

Drain system with a waste-disposal

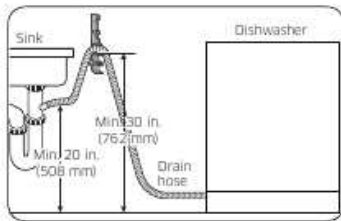
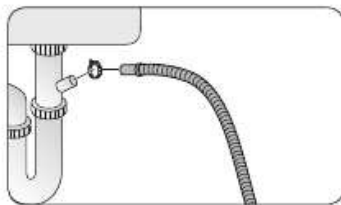
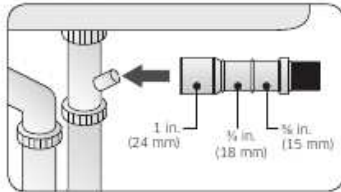

1. Check the size of the sink's drain hose connector. If needed, cut the drain hose so its end fits into the sink connector.

NOTE

If the drain hose does not fit into the sink connector, you can purchase an adaptor at a plumbing/hardware store.

2. Insert the drain hose into the sink connector, slide the hose clamp to the end of the hose, and then tighten the hose clamp.

3. When drilling a hole for the drain hose on the cabinet wall, use caution not to damage the drain hose on the sharp edges of the hole.
 - On wooden walls, use sand paper to soften the edges.
 - On metal walls, use insulation tape or duct tape to cover the sharp edges around the hole.
4. Secure the drain hose to the sink wall using cable ties or other fastening materials.
5. If there is no air gap, make sure to hang the middle of the drain hose well above the sink cabinet base to prevent back-flow (See the image on the left side).

CAUTION

- Use caution not to damage the drain hose when installing the dishwasher.
- Install the drain system properly so that the drain hose does not disconnect from the drain outlet in the draining process.
- Make sure that the drain hose, supply hose, or power cord is not kinked or folded.

Installation

Installation

STEP 8 Final check

1. Remove all foam, paper packaging, and unnecessary parts from inside the dishwasher.
2. Turn the circuit breaker on.
3. Open the water valve to supply water to the dishwasher.
4. Plug in the dishwasher.
5. Turn the dishwasher on, and then select and run a cycle.
6. Check if the dishwasher turns on normally and if there are any water leaks while the dishwasher is operating. Make sure to check for water leaks on both ends of the water line and the drain hose connector.
7. Check if the kick plate gasket is attached to the bottom of the kick plate. To install the kick plate, see the **Kick plate** section below.

Kick plate (BU model only)

If you want to install the kickplate, follow these instructions.

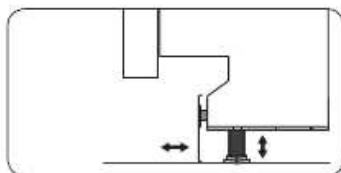

1. Turn the front legs of the dishwasher to adjust the height so that the kick plate fits in.

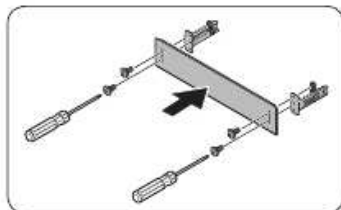

2. Attach the kickplate to the dishwasher using the kickplate brackets. Make sure the kickplate brackets are in the correct direction. See the figure for details.

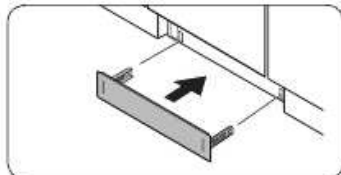

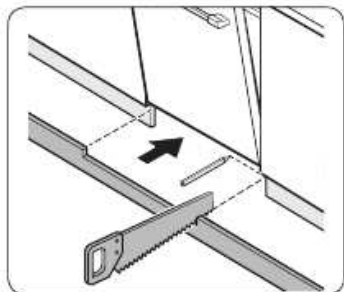

3. If you use the furniture plate instead of the kickplate, cut out the portion of the furniture plate that interrupts with the door before attaching the furniture plate to the dishwasher.

Installation

SAMSUNG

QUESTIONS OR COMMENTS?

COUNTRY	CALL	OR VISIT US ONLINE AT
U.S.A	1-800-SAMSUNG (726-7864) 1-844-SAM-PAYS (726-7297)	www.samsung.com/us/support
CANADA	1-800-SAMSUNG(726-7864) 1-844-SAM-PAYS (726-7297)	www.samsung.com/ca/support (English) www.samsung.com/ca_fr/support (French)
MEXICO	01-800-SAMSUNG (726-7864)	www.samsung.com/mx/support



DD81-02707A-00