

# RVH8303

UNDERMOUNT WORKSTATION SINK

# RUVATI®

SPECIFICATION SHEET

## MATERIAL

True 16 Gauge Thickness  
Premium T304 Grade Stainless Steel  
18/10 Chromium/Nickel Content  
Commercial Brushed Finish

## FEATURES

- Heavy duty sound guard padding and undercoating
- Slanted bottom with elegant drain grooves for easy draining
- Single-Tier Ledge for Accessories



## IN THE BOX

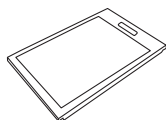

Cutting Board  
[RVA1217]

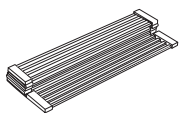

Folding Rack  
[RVA1395]

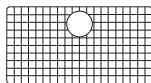

Rinse Grid  
[RVA68303]

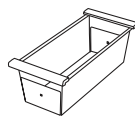

Colander  
[RVA1317]



Basket Strainer  
[RVA1025]



Drain Cover  
[RVA1035]

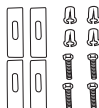

Mounting Clips  
[RVA11031]



Cut-out Template

## NOMINAL DIMENSIONS

Exterior: 33" (wide) x 19" (front-to-back)  
Interior Bowl: 31-3/8" (wide) x 16" (front-to-back)  
Bowl Depth: 10"  
Minimum Cabinet Size: 36" wide  
Drain Hole Size: 3 1/2"

Installation Type:  
Undermount

Inside Corners:  
Rounded

Drain Location:  
Rear Center

# RUVATI USA

www.ruvati.com

Phone: 1.855.478.8284  
Email: support@ruvati.com

## OPTIONAL ACCESSORIES (SOLD SEPARATELY)



Deep Basket  
Disposal Flange  
[RVA1049ST]

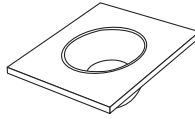

Mixing Bowl  
and Platform  
[RVA1288]

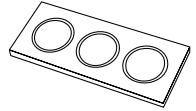

Condiment  
Serving Tray  
[RVA1377]

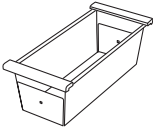

Colander  
[RVA1317]

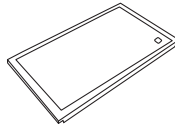

Black Plastic  
Cutting Board  
[RVA1217BLK]

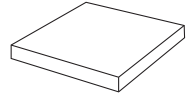

Butcher Block  
[RVA2445ACA]

## DIMENSIONS

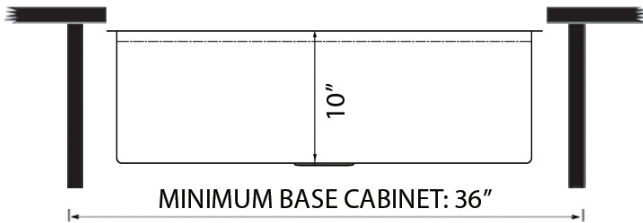
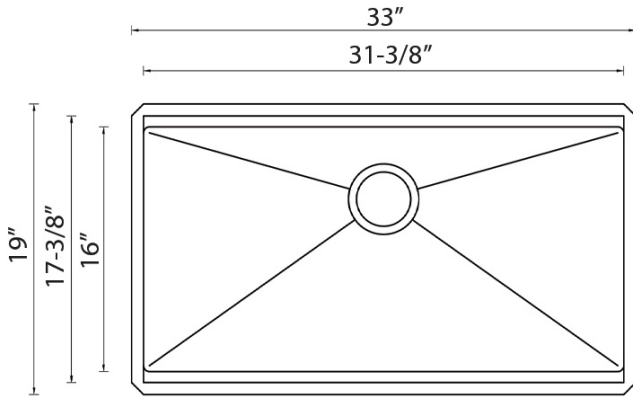

Register your product at [www.ruvati.com/register](http://www.ruvati.com/register).