

# RVH8262

TOPMOUNT WORKSTATION BAR SINK

**RUVATI**<sup>®</sup>  
SPECIFICATION SHEET

## MATERIAL

True 16 Gauge Thickness  
Premium T304 Grade Stainless Steel  
18/10 Chromium/Nickel Content  
Commercial Brushed Finish



## FEATURES

- Heavy duty sound guard padding and undercoating
- Built-in glass rinser with drying rack
- Single-Tier Ledge for Accessories

## IN THE BOX



Basket Strainer  
[RVA1025]



Mounting Clips  
[RVA11042]



Flex Hose  
[RVA11025]

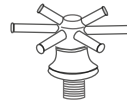

Sprayer Assembly  
[RVA11026]

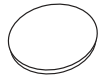

Drain Cover  
[RVA1035]



Cut-out  
Template

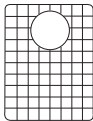

Rinse Grid  
[RVA68210]

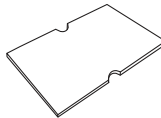

Cutting Board  
[RVA1210]

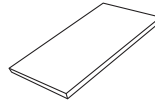

Cutting Board  
[RVA1242]

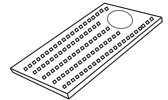

Drainer Grate  
[RVA11027]

## NOMINAL DIMENSIONS

**Exterior:** 22" (wide) x 20" (front-to-back)

**Interior Bowl:** 13" x 14-5/8" (left), 7" x 14-5/8" (right)

**Bowl Depth:** 10"

**Minimum Cabinet Size:** 24" wide

**Drain Hole Size:** 3 1/2"

## Installation Type:

Topmount

## Inside Corners:

Rounded

## Drain Location:

Rear Center

# RUVATI USA

www.ruvati.com

Phone: 1.855.478.8284  
Email: support@ruvati.com

# OPTIONAL ACCESSORIES (SOLD SEPARATELY)



Deep Basket  
Disposal Flange  
[RVA1049ST]

## DIMENSIONS

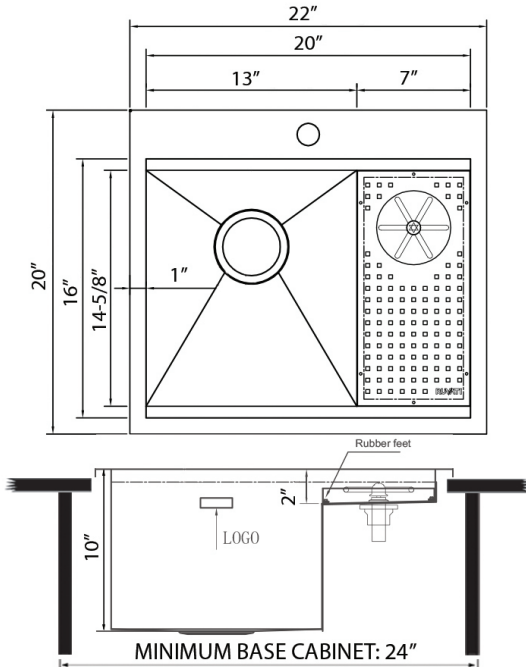

Register your product at [www.ruvati.com/register](http://www.ruvati.com/register).