

# RVH7118

## UNDERMOUNT BAR SINK

**RUVATI**<sup>®</sup>  
SPECIFICATION SHEET

### MATERIAL

True 16 Gauge Thickness  
Premium T304 Grade Stainless Steel  
18/10 Chromium/Nickel Content  
Commercial Brushed Finish



### FEATURES

- Heavy duty sound guard padding and undercoating
- Slanted bottom with elegant drain grooves for easy draining
- Rounded inside corners



### IN THE BOX



Basket Strainer  
[RVA1025]

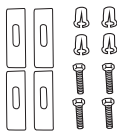

Mounting Clips  
[RVA11031]



Drain Cover  
[RVA1035]



Cut-out  
Template

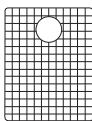

Rinse Grid  
[RVA68006]

### NOMINAL DIMENSIONS

Exterior: 18" (wide) x 18" (front-to-back)  
Interior Bowl: 16" (wide) x 16" (front-to-back)  
Bowl Depth: 9"  
Minimum Cabinet Size: 21" wide  
Drain Hole Size: 3½"

Installation Type:  
Undermount  
Inside Corners:  
Rounded  
Drain Location:  
Rear Center

**RUVATI USA**  
www.ruvati.com

Phone: 1.855.478.8284  
Email: support@ruvati.com

# OPTIONAL ACCESSORIES (SOLD SEPARATELY)



Deep Basket  
Disposal Flange  
[RVA1049ST]

## DIMENSIONS

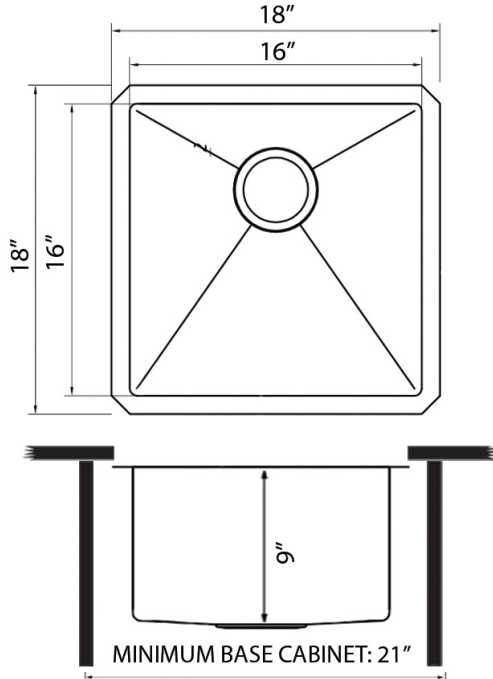

Register your product at [www.ruvati.com/register](http://www.ruvati.com/register).