

RVH8304

UNDERMOUNT WORKSTATION SINK

RUVATI[®]
SPECIFICATION SHEET

MATERIAL

True 16 Gauge Thickness
Premium T304 Grade Stainless Steel
18/10 Chromium/Nickel Content
Commercial Brushed Finish

FEATURES

- Heavy duty sound guard padding and undercoating
- Slanted bottom with elegant drain grooves for easy draining
- Single-Tier Ledge for Accessories

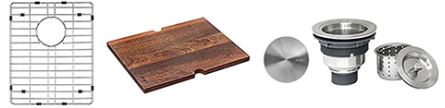

IN THE BOX

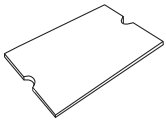

Cutting Board
[RVA1204]

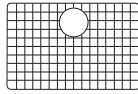

Rinse Grid
[RVA68304]



Cut-out
Template



Basket Strainer
[RVA1025]



Drain Cover
[RVA1035]

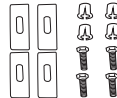

Mounting Clips
[RVA11031]

NOMINAL DIMENSIONS

Exterior: 15" (wide) x 19" (front-to-back)
Interior Bowl: 13-1/2"(wide) x 16" (front-to-back)
Bowl Depth: 10"
Minimum Cabinet Size: 18" wide
Drain Hole Size: 3 1/2"

Installation Type:
Undermount

Inside Corners:
Zero Radius

Drain Location:
Rear Center

RUVATI USA

www.ruvati.com

Phone: 1.855.478.8284
Email: support@ruvati.com

OPTIONAL ACCESSORIES (SOLD SEPARATELY)



Deep Basket
Disposal Flange
[RVA1049ST]

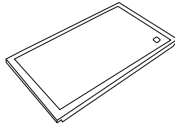

Black Plastic
Cutting Board
[RVA1217BLK]

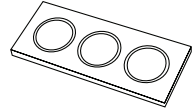

Condiment
Serving Tray
[RVA1377]

DIMENSIONS

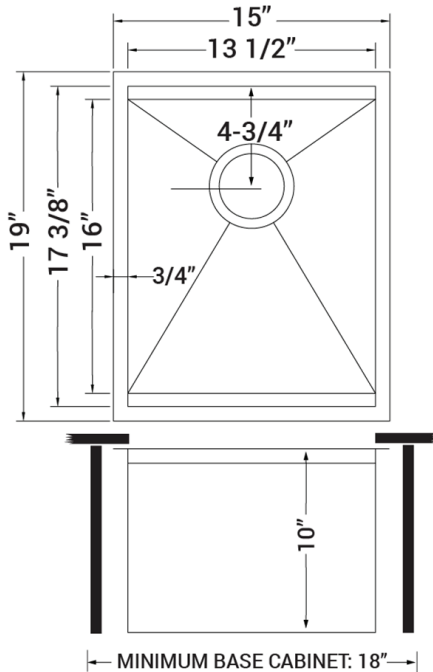

Register your product at www.ruvati.com/register.