

INSTALLATION INSTRUCTIONS FOR REL20-1 / REL21-1 / REL22-1 / REL23-1 LED EMERGENCY LIGHT

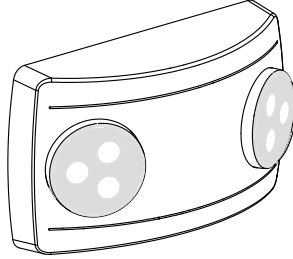

IMPORTANT SAFEGUARDS

READ AND FOLLOW ALL SAFETY INSTRUCTIONS

When using electrical, basic safety precautions should always be followed including the following.

1. Disconnect power at fuse or circuit breaker before installing or servicing.
2. Do not use outdoors.
3. Do not mount in hazardous locations, or near gas or electric heaters.
4. Do not let power cords touch hot surface.
5. Equipment should be mounted in locations and at heights where it will not be subjected to tampering by unauthorized personnel.
6. The use of accessory equipment not recommend by the manufacturer may cause an unsafe condition.
7. Do not use this equipment for other than intended use.
8. All servicing should be performed by a qualified personnel only.
9. Allow battery to charge for 24 hours before first use, for 2 batteries model, need 48 hours fully charge batteries.

SAVE THESE INSTRUCTIONS

Use Flexible Conduit Only

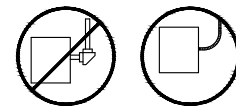

MAINTENANCE

None required. Replace the batteries as needed according to ambient conditions. However, we recommend that the equipment be tested regularly in accordance with local codes.

OPERATION

Press the test button. The LED heads will turn on and the LED indicator will turn off. Release the test switch, LED indicator will turn on and the LED heads will turn off.

TROUBLE SHOOTING GUIDE

If LED heads or LED indicator does not illuminate, check the following:

1. Check AC supply - verify that unit has 24 hours AC supply.
2. Unit is shorted or battery is not connected.
3. Battery discharge. Permit unit to charge for 24 hours or 48 hours (for 2 batteries model) and then re-test.
4. Battery have to recharge if product keep in stock over 9 months, detail manual refer "BATTERY STOCK AND RECHARGE GUIDELINE".
5. If above trouble shooting hints do not solve you problem, contact factory for assistance.

Mounting Instructions

Wall Mount-Back Power Feed (see Fig 2)

1. Use flat blade screwdriver insert the two slots and pry off front cover from back plate (see Fig 1).
2. Remove appropriate knockout in back plate and mount back plate to J-box.
3. Knockout in center of back plate and feed wires through the hole.
4. Securely backplate to J-box.
5. Connect the J-box wires to the power supply wires using the wire nuts provided. Connect the white wire to neutral. If using 120V, connect the black wire to the hot lead. If using 277V, connect the orange wire to the hot lead. Cap the unused lead. Press the wires into the J-box (Refer to Wiring diagram below).
6. Connect remote heads. Refer to below instruction for remote heads.
7. Connect battery connector.(see Fig 2).
8. Snap the front cover onto the back plate.
9. Restore power and press test button. LED heads will turn on.
10. Adjust the lamp head and lens direction as per needs(see Fig 5).

Open fixture

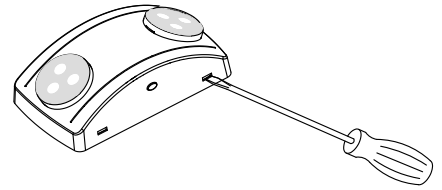

Fig 1

Wall mount-Back Power Feed

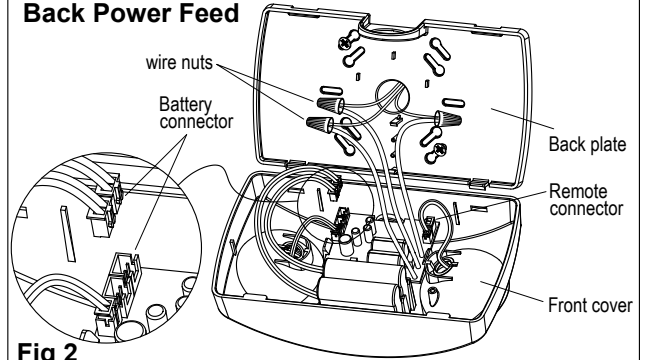

Fig 2

Ceiling Mount -Top Power Feed (see Fig 3)

Refer to above **Wall mount-Back Power Feed** instruction.

Here is some differences :

Mount back plate on the ceiling surface instead of wall surface.
Feed building AC supply wire through back plate then connect to fixture power supply wires using wire nuts provided.

Ceiling mount-Top Power Feed

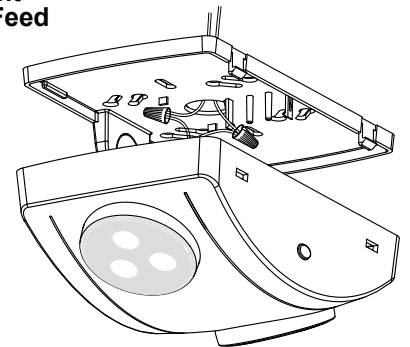

Fig 3

Wall Mount- Surface Wiring (Top Power Feed) (see Fig 4)

1. Open front cover and remove top knockout on the top flange of fixture.
2. Secure conduit (or surface raceway) to knockout and feed wires.
3. Remove keyhole knockout on back plate and mount to wall.
4. Refer to above 5 - 10 steps in Wall Mount-Back Power Feed.

Connecting Remote heads (see Fig 2)

Attach remote wire on remote connector on PCBA,
Connect remote heads extended wire to remote wire, yellow is positive(+), purple is negative(-). connect wires using wire nuts.

Remote capability reference below:
REL22-1 has max. 3.6V 2W remote capabilities.

Wall mount-Top Power Feed

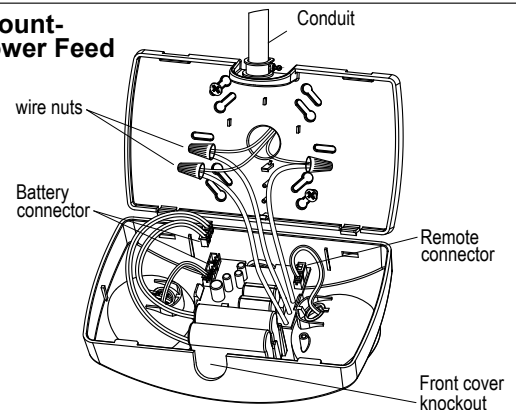
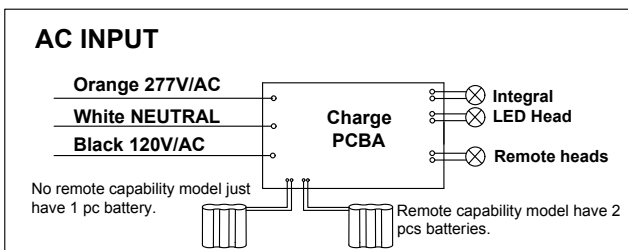

Fig 4

Wiring Diagram



Max.mounting height

REL20-1:15ft

REL21-1 / REL22- 1 / REL23-1:26ft

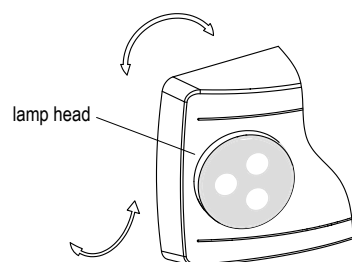

Fig 5