

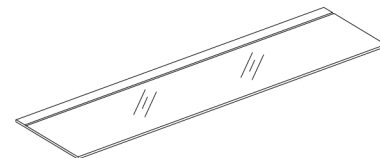
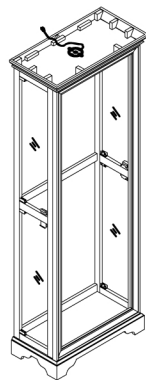
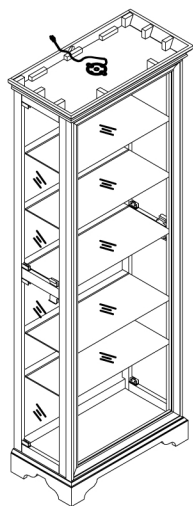

WARNING

Serious or fatal crushing injuries can occur from furniture tip-over. To help prevent tip-over:

- install tipover restraint provided.
- Place heaviest items in the lowest drawers.
- Do not set TV's or other heavy objects on top of this product unless the product is specifically designed to accommodate them.
- Never allow children to climb or hang on drawers, doors, or shelves.
- Never open more than one drawer at a time (OR)
- Do not defeat or remove the drawers interlock system.

Use of tip-over restraints may only reduce, but not eliminate, the risk of tip-over. this is a permanent label. Do not remove!

A

x1 Curio
x1 Vitrine
x1 Vitrina

B

x5 Glass shelf *
x5 Étagère en verre
x5 Estante de vidrio

C

x18 Common Shelf Support *
x18 Supports Pour Tablette
x18 Soporte De Las Repisas

D

x1 Furniture Tipping Restraint
x1 Systeme antibasculement
x1 Control para evitar vulcos

* Replaceable Part

⚠ WARNING

Serious or fatal crushing injuries can occur from furniture tip-over. To help prevent tip-over:

- install tipover restraint provided.
- Place heaviest items in the lowest drawers.
- Do not set TV's or other heavy objects on top of this product unless the product is specifically designed to accommodate them.
- Never allow children to climb or hang on drawers, doors, or shelves.
- Never open more than one drawer at a time (OR)
- Do not defeat or remove the drawers interlock system.

Use of tip-over restraints may only reduce, but not eliminate, the risk of tip-over. this is a permanent label. Do not remove!

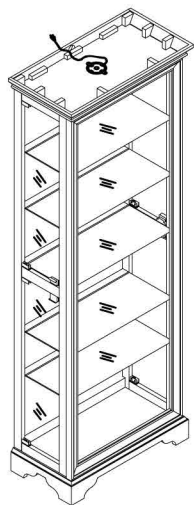

Door pull
Poignée de tirage
Manilla para tirar

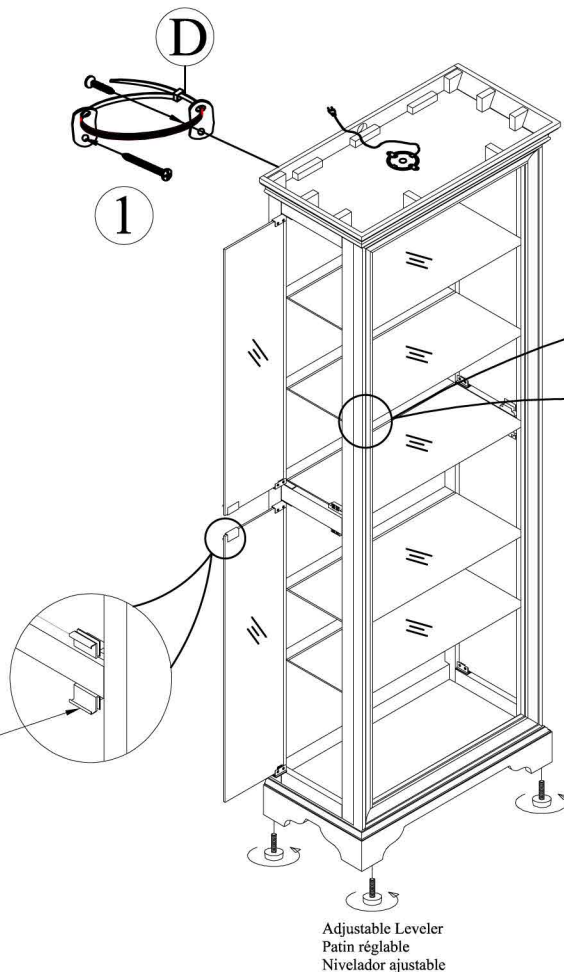

Adjustable Leveler
Patin réglable
Nivelador ajustable

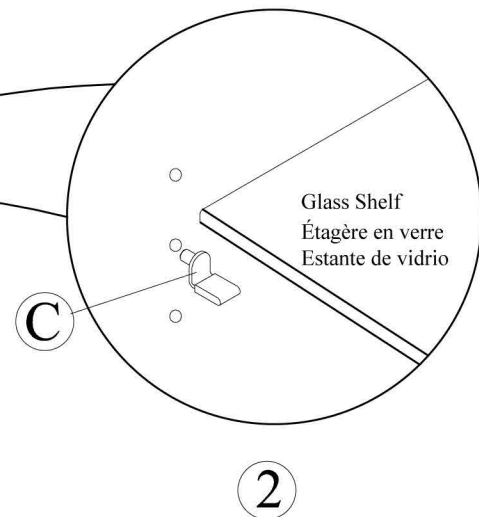

Glass Shelf
Étagère en verre
Estante de vidrio

⚠ WARNING

Serious or fatal crushing injuries can occur from furniture tip-over. To help prevent tip-over:

- install tipover restraint provided.
- Place heaviest items in the lowest drawers.
- Do not set TV's or other heavy objects on top of this product unless the product is specifically designed to accommodate them.
- Never allow children to climb or hang on drawers, doors, or shelves.
- Never open more than one drawer at a time (OR)
- Do not defeat or remove the drawers interlock system.

Use of tip-over restraints may only reduce, but not eliminate, the risk of tip-over. this is a permanent label. Do not remove!

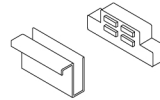
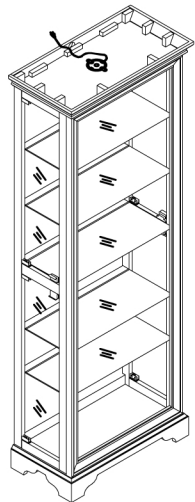

x4 RC-PULL-02
Glass Door Pull (Brass) with Felt *
Poignée (Laiton) et Feutre
Tirador (Latón) y Fieltro

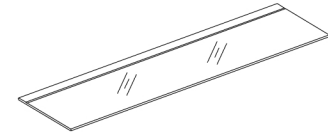

x5 R21307-61 *
Glass shelf *
Étagère en verre
Estante de vidrio



x4 R21307-60
Door Glass
Porte en verre
Puerta de vidrio



x18 RC-SUPPORT-01
Common Shelf Support *
Supports Pour Tablette
Soporte De Las Repisas

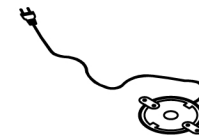

x1 RC-LIGHT-01
Light fixture w/roll switch *
lumière et interrupteur
luz y interruptor

* Replaceable Part