

A

- x1 Chair Back *
- x1 Dossier de chaise *
- x1 Respaldo de la silla

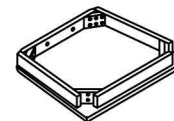

B

- x1 Chair Seat *
- x1 Siège de chaise *
- x1 Asiento de silla



C

- x2 Legs *
- x2 Jambes *
- x2 Piernas

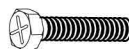
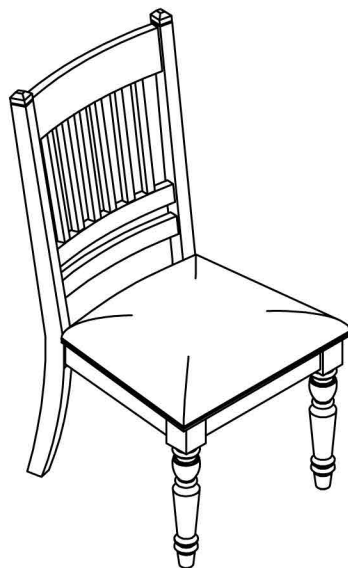

D

- x2 Allen bolt Ø5/16"x40mm *
- x2 Vis à tête creuse hexagonale Ø5/16"x40mm
- x2 Perno Allen Ø5/16"x40mm



E

- x4 Allen bolt Ø5/16"x80mm *
- x4 Vis à tête creuse hexagonale Ø5/16"x80mm
- x4 Perno Allen Ø5/16"x80mm



F

- x4 Hex nut 12*12*6 mm *
- x4 écrou hexagonal 12*12*6 mm
- x4 Tuerca hexagona 12*12*6 mm



G

- x10 Lock washer Ø5/16" *
- x10 Rondelle de blocage Ø5/16"
- x10 Arandela de Seguridad Ø5/16"



H

- x10 Flat Washer Ø5/16"x19x1.8mm *
- x10 Rondelle plate Ø5/16"x19x1.8mm
- x10 Arandela plana Ø5/16"x19x1.8mm



J

- x1 Open Wrench Ø5/16" *
- x1 Clé à fourche Ø5/16"
- x1 Llave de boca Ø5/16"

* Replaceable Part

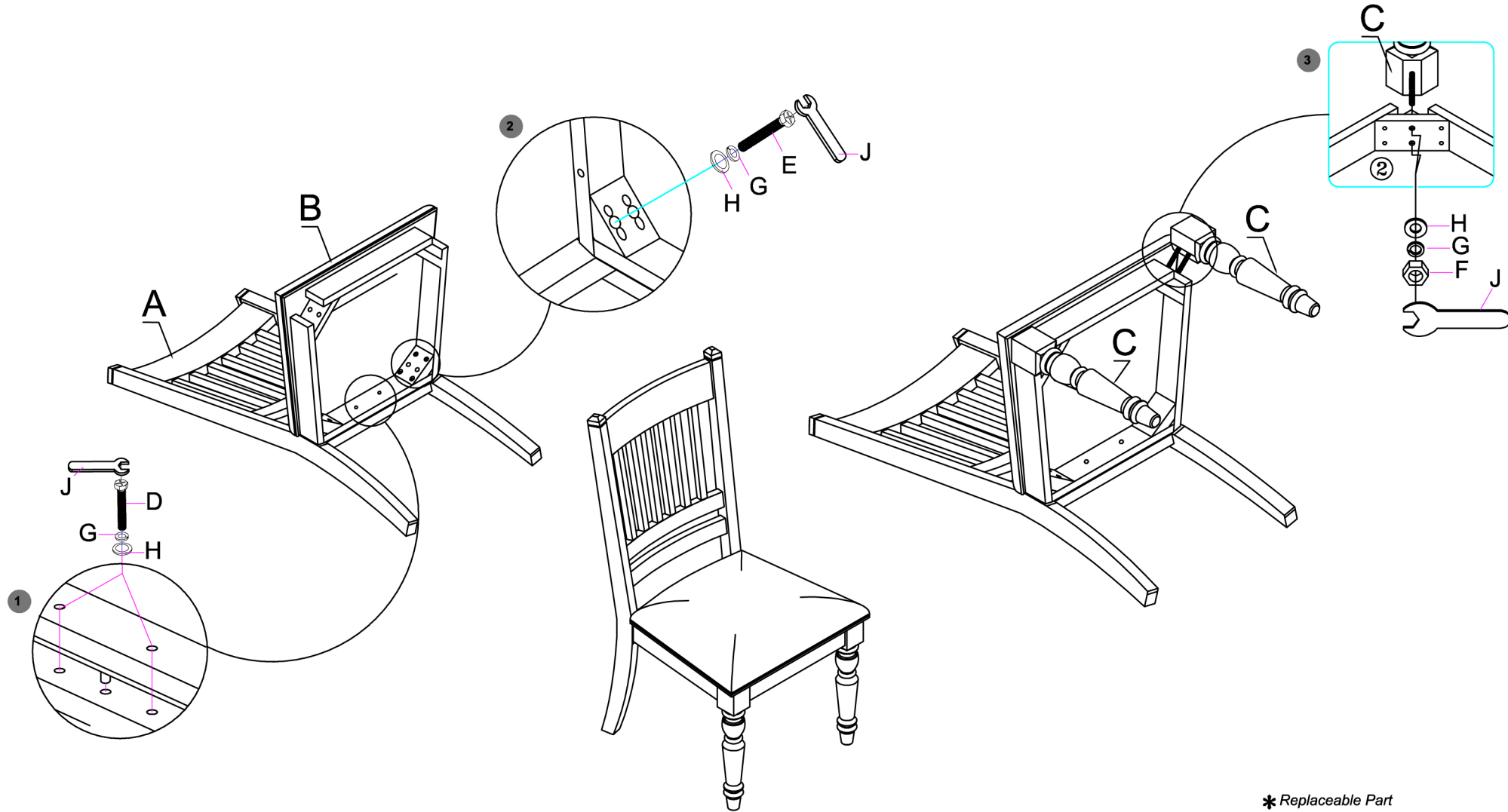

* Replaceable Part

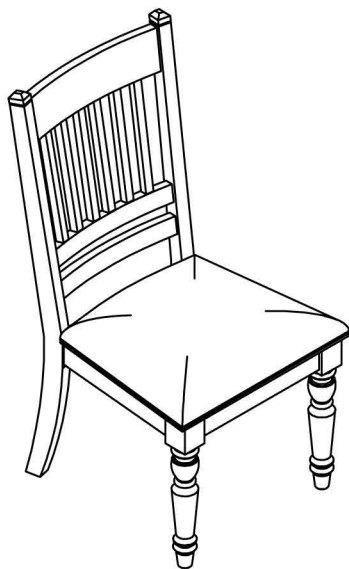

x2 S786-154-LEGF- Front Leg *
 Patte avant
 Pata delantera



x1 S786-154-HWKIT-Hardware kit list *
 Liste des pièces de quincaillerie
 Lista del kit de materiales

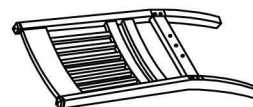

A

x1 S786-154-BACK-Chair Back *
 Dossier de chaise
 Respaldo de la silla

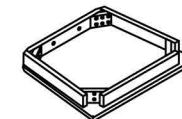

B

x1 S786-155-CUSHION-Chair Seat *
 Siège de chaise
 Asiento de silla