

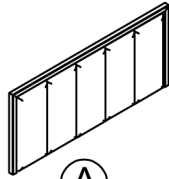

PARTS LIST / LISTE DES PIÈCES / LISTA DE PIEZAS

DESCRIPTION / DESCRIPCIÓN : 6/6-6/0 Upholstered Bed HB - Tête de très grand lit standard et californien capitonnée - Cabecera de cama tapizada de 6/6-6/0
 6/6-6/0 Panel Footboard w/Slats - Pied de très grand lit standard et californien en panneau avec banc de lit - Pie de cama estilo panel con listones de 6/6-6/0
 5/0 & 6/6 Set of Side Rails - Traverses de grand lit et très grand lit - Juego de travesaños laterales de cama de 5/0 y 6/6

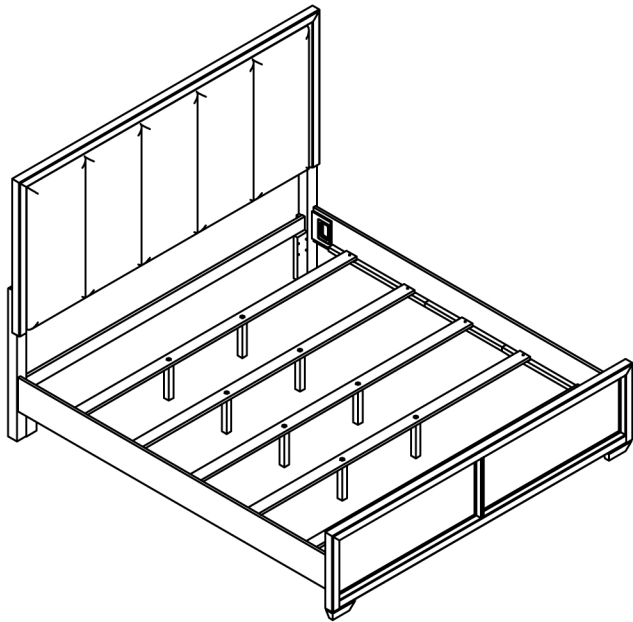

(A)
 x1 Headboard panel
 x1 Tête de lit
 x1 Panel de la cabecera

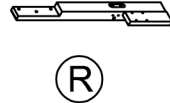

(R)
 x1 Headboard Legs (Right) *
 x1 Pattes de la tête de lit (gauche et droite)
 x1 Patas de cabecera (izquierda y derecha)

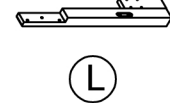

(L)
 x1 Headboard Legs (Left) *
 x1 Pattes de la tête de lit (gauche et droite)
 x1 Patas de cabecera (izquierda y derecha)

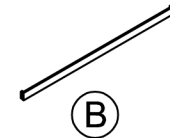

(B)
 x1 Safety rail *
 x1 Garde-corps
 x1 Baranda de seguridad

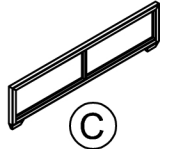

(C)
 x1 Footboard Panel
 x1 Pied de lit
 x1 Panel de pie de cama

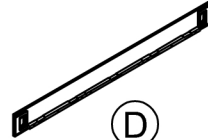

(D)
 x2 Side Rail
 x2 Traverse
 x2 Travesaño lateral

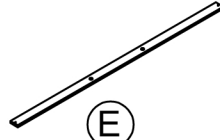

(E)
 x5 Slats *
 x5 Lattes
 x5 Listones

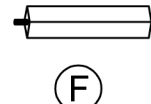

(F)
 x10 Slat support leg *
 x10 Pattes de supports
 x10 Patas de apoyo de listones



(G)
 x8 Allen bolt Ø5/16"x50mm *
 x8 Vis à tête creuse hexagonale Ø5/16"x50mm
 x8 Perno Allen Ø5/16"x50mm



(H)
 x8 Lock washer Ø5/16" *
 x8 Rondelle de blocage Ø5/16"
 x8 Arandela de Seguridad Ø5/16"

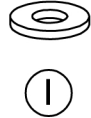

(I)
 x8 Flat Washer Ø5/16"x16x1.5mm *
 x8 Rondelle plate Ø5/16"x16x1.5mm
 x8 Arandela plana Ø5/16"x16x1.5mm

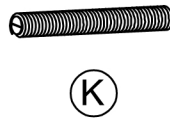

(K)
 x8 Hanger Bolt Ø5/16"x100mm *
 x8 Vis à tête creuse hexagonale-vis Ø5/16"x100mm
 x8 Perno de suspensión Ø5/16"x100mm



(M)
 x8 Lock washer Ø5/16" *
 x8 Rondelle de blocage Ø5/16"
 x8 Arandela de Seguridad Ø5/16"

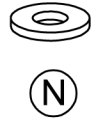

(N)
 x8 Flat Washer Ø5/16"x16x1.5mm *
 x8 Rondelle plate Ø5/16"x16x1.5mm
 x8 Arandela plana Ø5/16"x16x1.5mm



(P)
 x8 Hex nut Ø5/16"x6mm *
 x8 Écrou hexagonal Ø5/16"x6mm
 x8 Tuerca hexagonal Ø5/16"6mm



(Q)
 x1 Allen Key 4mm *
 x1 Clé hexagonale 4mm
 x1 Llave Allen 4mm



(S)
 x1 Open Wrench 12mm *
 x1 Clé à fourche 12mm
 x1 Llave de boca 12mm



(T)
 x10 Wood Screw #8x25mm *
 x10 Vis à bois #8x25mm
 x10 Tornillo para madera #8x25mm



(U)
 x4 Dowel Ø8x30mm *
 x4 Gonjou Ø8x30mm
 x4 Tarugo Ø8x30mm

* Replaceable Part

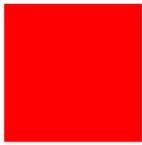

ASSEMBLY INSTRUCTION / NOTICE DE MONTAGE/ INSTRUCCIONES DE MONTAJE

DESCRIPTION / DESCRIPCIÓN : 6/6-6/0 Upholstered Bed HB - Tête de très grand lit standard et californien capitonnée - Cabecera de cama tapizada de 6/6-6/0
6/6-6/0 Panel Footboard w/Slats - Pied de très grand lit standard et californien en panneau avec banc de lit - Pie de cama estilo panel con listones de 6/6-6/0
5/0 & 6/6 Set of Side Rails - Traverses de grand lit et très grand lit - Juego de travesaños laterales de cama de 5/0 y 6/6

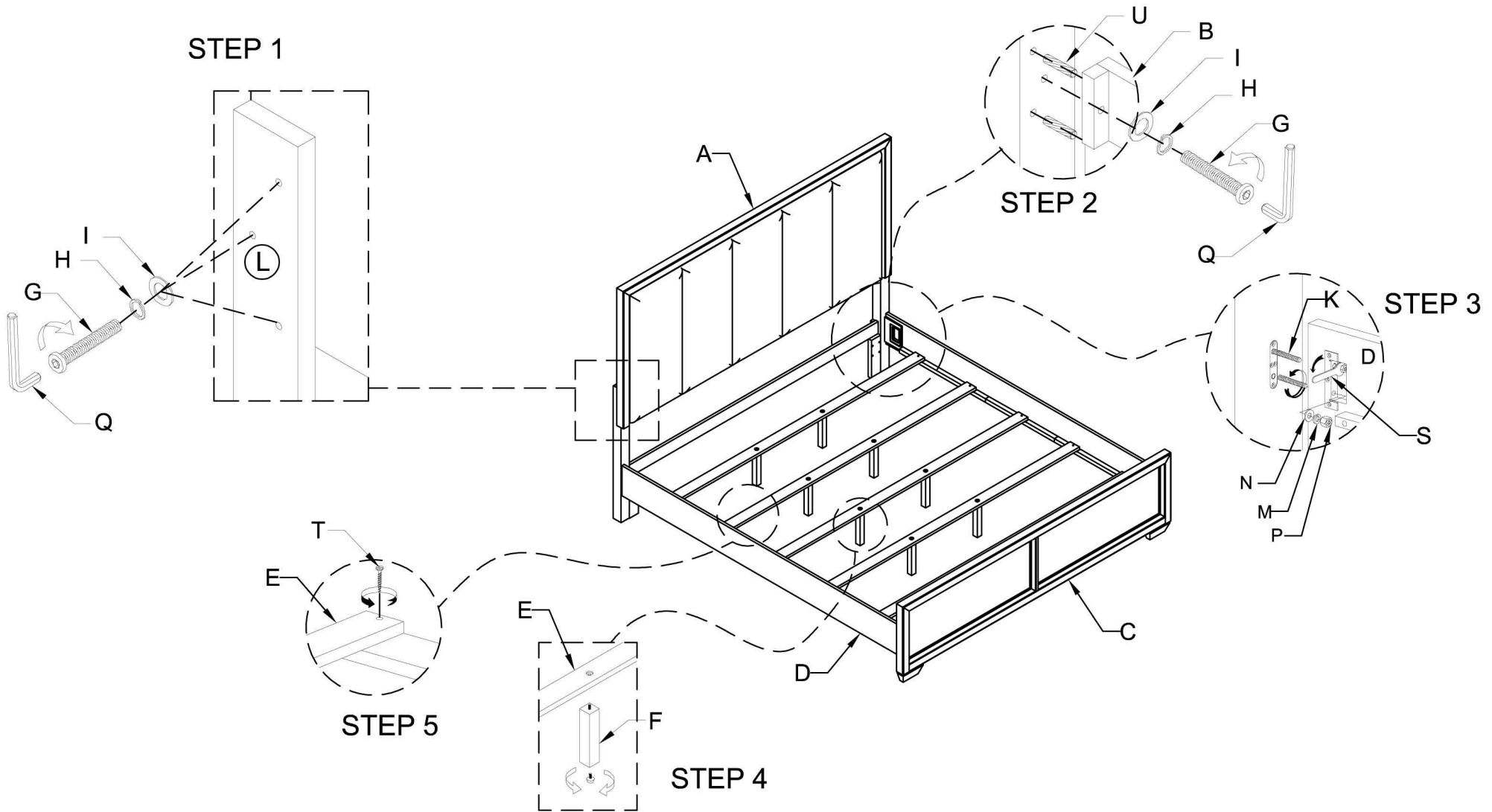

* Replaceable Part



REPLACEABLE PART/ PARTIE REMPLACABLE/ PARTE REEMPLAZABLE

DESCRIPTION / DESCRIPCIÓN : 6/6-6/0 Upholstered Bed HB - Tête de très grand lit standard et californien capitonnée - Cabecera de cama tapizada de 6/6-6/0
6/6-6/0 Panel Footboard w/Slats - Pied de très grand lit standard et californien en panneau avec banc de lit - Pie de cama estilo panel con listones de 6/6-6/0
5/0 & 6/6 Set of Side Rails - Traverses de grand lit et très grand lit - Juego de travesaños laterales de cama de 5/0 y 6/6

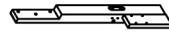
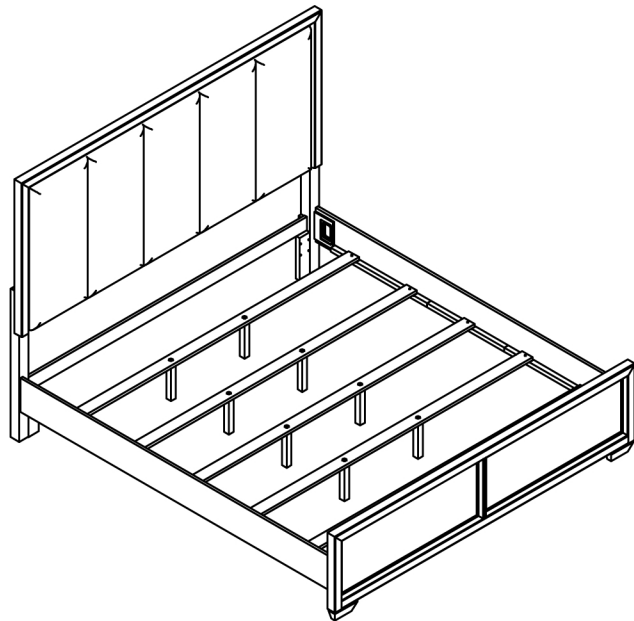

x1 RS714-272-LEGR-Right Leg *
Patte de droite
Pata derecha

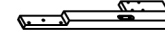

x1 RS714-272-LEGL-Left Leg *
Patte de gauche
Pata izquierda

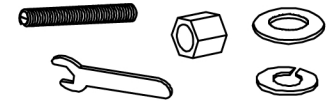

x1 RS714-400-HWKIT-Hardware Kit *
Liste des pièces de quincaillerie
Lista de materiales

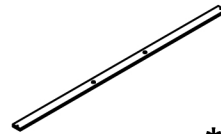

x5 RS714-273-SLAT-Slat *
Lattes
Listones



x1 RS714-272-RAIL-Safety rail *
Garde-corps
Baranda de seguridad

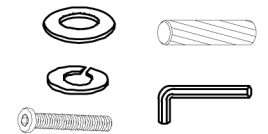

x1 RS714-272-HWKIT-Hardware Kit *
Liste des pièces de quincaillerie
Lista de materiales



x4 RC-WH-NAIL-White Plastic Nail *
Clou en plastique
Clavo de plástico

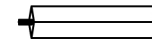

x10 RS714-273-SULEG- Slat support leg *
Pattes de supports
Patatas de apoyo de listones



x10 RS714-253-SCREW- Screw *
Vis
Tornillo

* Replaceable Part

Protect Your Wood or Laminate Flooring

*This statement applies to any floor without carpet.

If not careful, all furniture including upholstery and case pieces can scratch, scuff and even gouge floors. The recommendation is to have felt, rubber pads or area rugs under furniture on flooring without carpet.

Moving your furniture

Pushing and dragging furniture over floors without carpet can lead to scratches and scuffs. Have someone help when moving the larger pieces of furniture by lifting, try using a dolly or moving pads.

Felt and rubber pads

Applying furniture pads to the feet of furniture helps cushion contact points. Furniture pads can be found at local hardware stores. Felt pads slide easily across the floor, making them ideal for dining chairs and other pieces that move with use. Rubber pads will help furniture stay in place and are perfect for larger pieces, like sofas and loveseats.

Area rugs and rug pads

Using an area rug under furniture is another way to protect your floor from scratches and scuff marks. A rug pad under the area rug will provide extra cushion and added protection.