

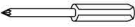





ASSEMBLY INSTRUCTIONS



DESCRIPTION: DRESSER / MIRROR

Thank you for purchasing this quality product. Be sure to check all packing material carefully for small parts that may have come loose inside the carton during shipment. Identify and count all hardware and compare with the hardware list below.

TOOLS REQUIRED (NOT PROVIDED)	
Phillips screwdriver	

HARDWARE LIST MIRROR:				
No.	Description	Sketch	Size	Q'ty
A	Allen bolt		1/4" x 30 x 1.3/16"	8 Pcs
B	Lock washer		1/4"	8 Pcs
C	Flat washer		1/4" x 3/4"	8 Pcs
D	L Allen key		M4	1 Pc

HARDWARE LIST DRESSER:				
No.	Description	Sketch	Size	Q'ty
E	Furniture Tipping Restraint			1 Set

PARTS LIST:			
No.	Description	Sketch	Q'ty
1	Mirror		1 Pc
2	Mirror Support		2 Pcs
3	Dresser		1 Pc

NOTE : TRAY BOX FOR LEFT DRAWER ONLY !

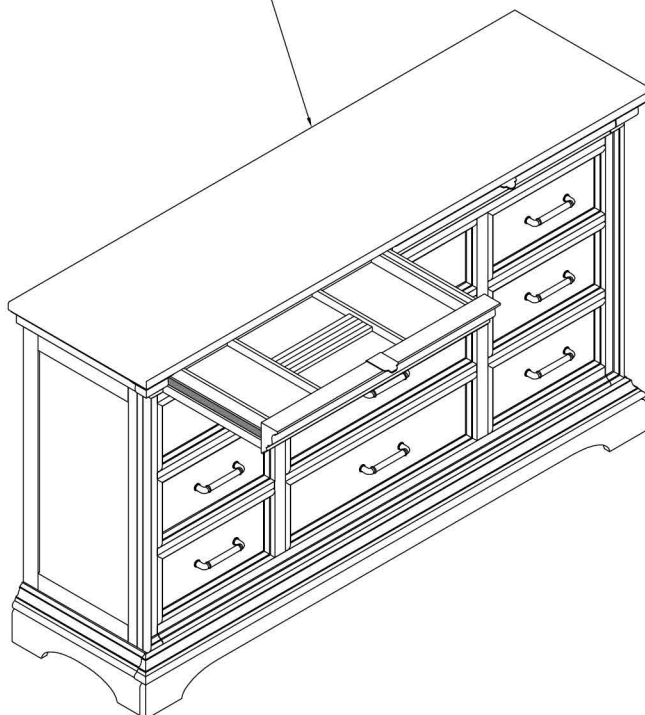

ASSEMBLY INSTRUCTIONS

DESCRIPTION: DRESSER / MIRROR

Thank you for purchasing this quality product. Be sure to check all packing material carefully for small parts that may have come loose inside the carton during shipment. Identify and count all hardware and compare with the hardware list below.

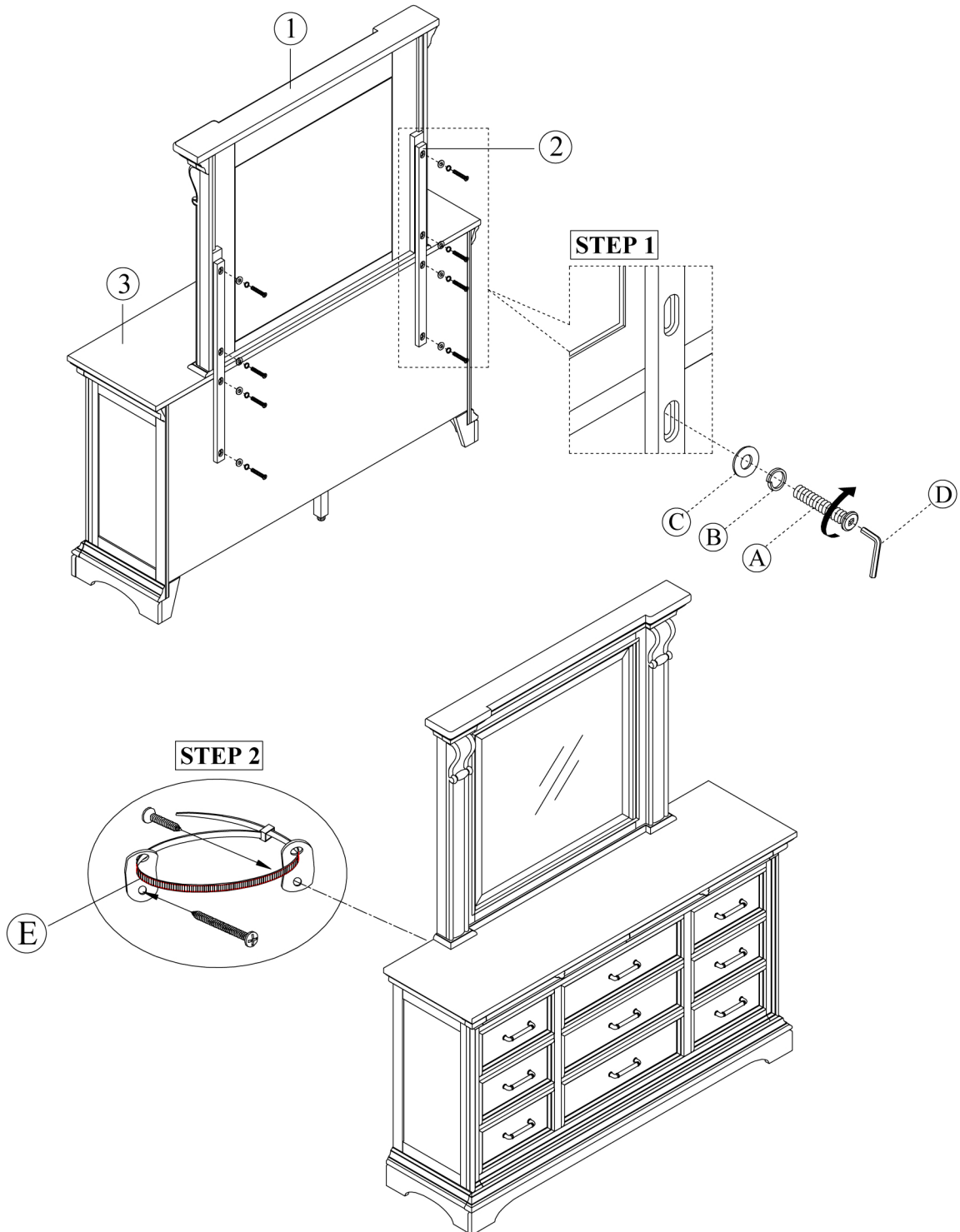

RESIDENTIAL USE ONLY

MADE IN VIET NAM