

# ASSEMBLY INSTRUCTIONS

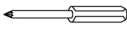



## DESCRIPTION: QUEEN PANEL BED

Thank you for purchasing this quality product. Be sure to check all packing material carefully for small parts that may have come loose inside the carton during shipment. Identify and count all hardware and compare with the hardware list below.

### TOOLS REQUIRED (NOT PROVIDED)

Phillips screwdriver 





### HARDWARE LIST HEADBOARD:

| No. | Description | Sketch  | Size           | Q'ty   |
|-----|-------------|---|----------------|--------|
| A   | Allen bolt  |  | Ø1/4" x 2.3/8" | 10 Pcs |
| B   | Lock washer |  | Ø1/4"          | 10 Pcs |
| C   | Flat washer |  | Ø1/4" x 3/4"   | 10 Pcs |
| D   | L Allen key |  | M4             | 1 Pc   |





### HARDWARE LIST FOOTBOARD:

| No. | Description | Sketch  | Size        | Q'ty   |
|-----|-------------|---|-------------|--------|
| E   | Screw       |  | M4 x 1.1/4" | 10 Pcs |

### HARDWARE LIST RAIL:

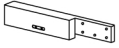
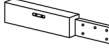
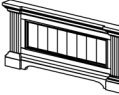
| No. | Description | Sketch  | Size            | Q'ty  |
|-----|-------------|---|-----------------|-------|
| F   | Hanger bolt |    | Ø5/16" x 3.1/2" | 8 Pcs |
| G   | Hexagon nut |   | Ø5/16"          | 8 Pcs |
| H   | Lock washer |  | Ø5/16"          | 8 Pcs |
| I   | Wrench      |  | 12mm            | 1 Pc  |

### PARTS LIST:

| No. | Description         | Sketch  | Q'ty  |
|-----|---------------------|---|-------|
| 1   | Headboard           |    | 1 Pc  |
| 2   | Headboard Leg-Right |    | 1 Pc  |
| 3   | Headboard Leg-Left  |    | 1 Pc  |
| 4   | Footboard           |    | 1 Pc  |
| 5   | Slat                |    | 5 Pcs |
| 6   | Support Leg         |    | 5 Pcs |
| 7   | Side Rail           |  | 2 Pcs |

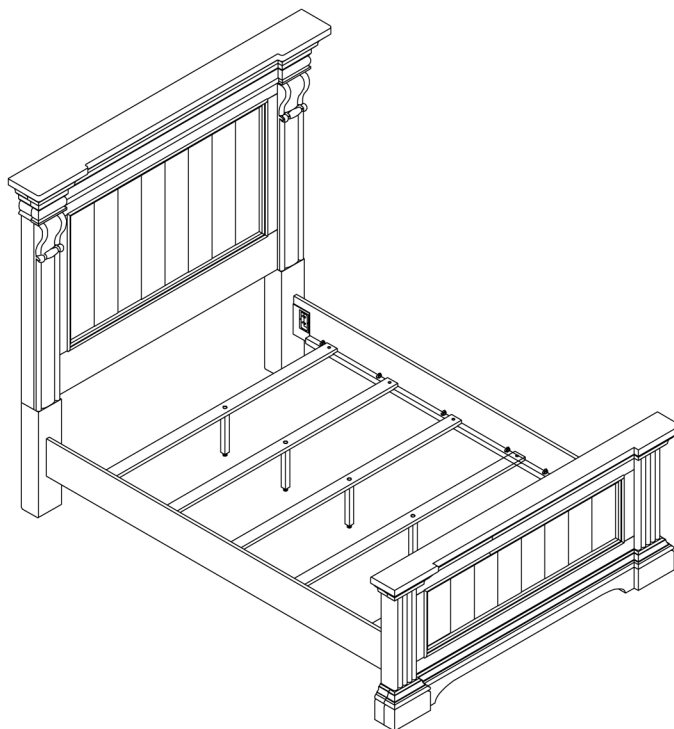

RESIDENTIAL USE ONLY

MADE IN VIET NAM

# ASSEMBLY INSTRUCTIONS

## DESCRIPTION: QUEEN PANEL BED

Thank you for purchasing this quality product. Be sure to check all packing material carefully for small parts that may have come loose inside the carton during shipment. Identify and count all hardware and compare with the hardware list below.

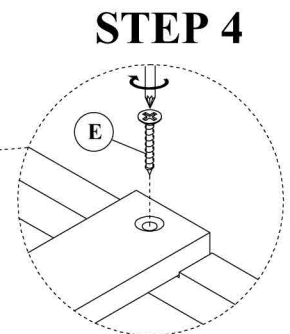
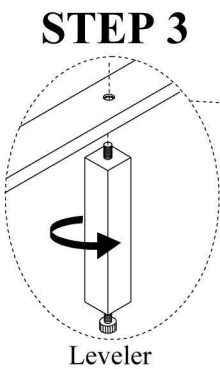
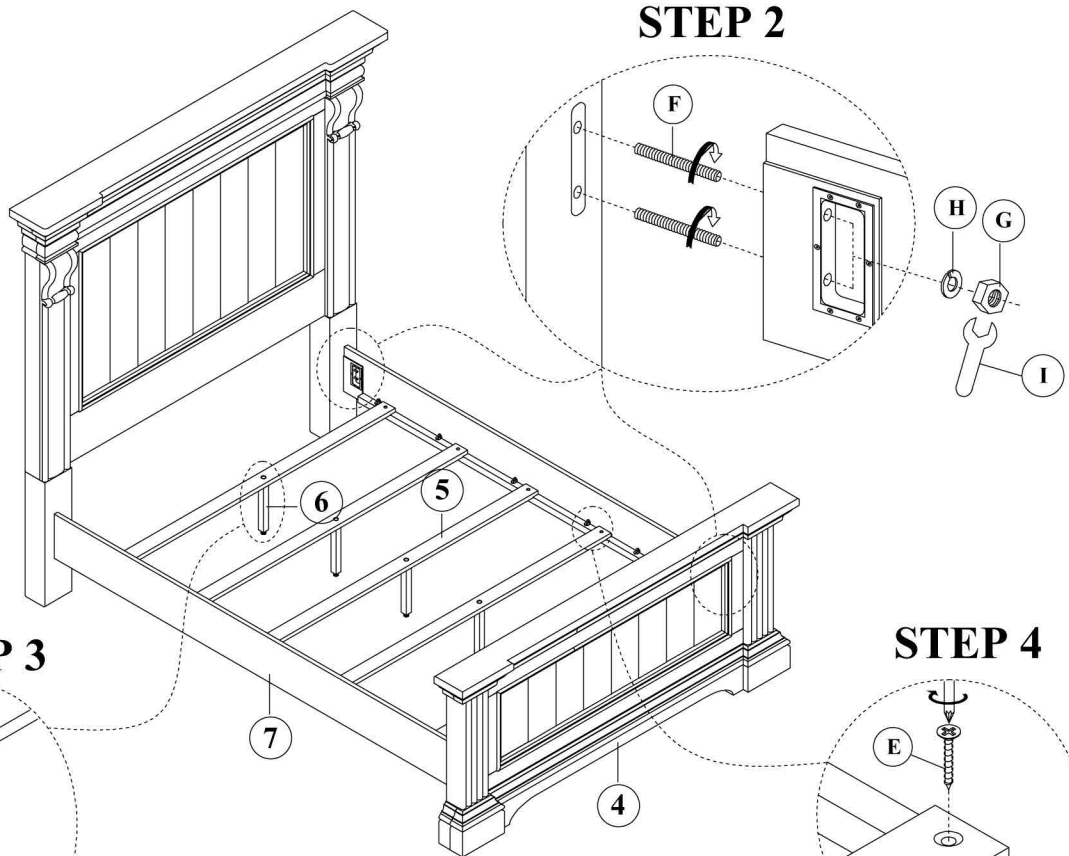
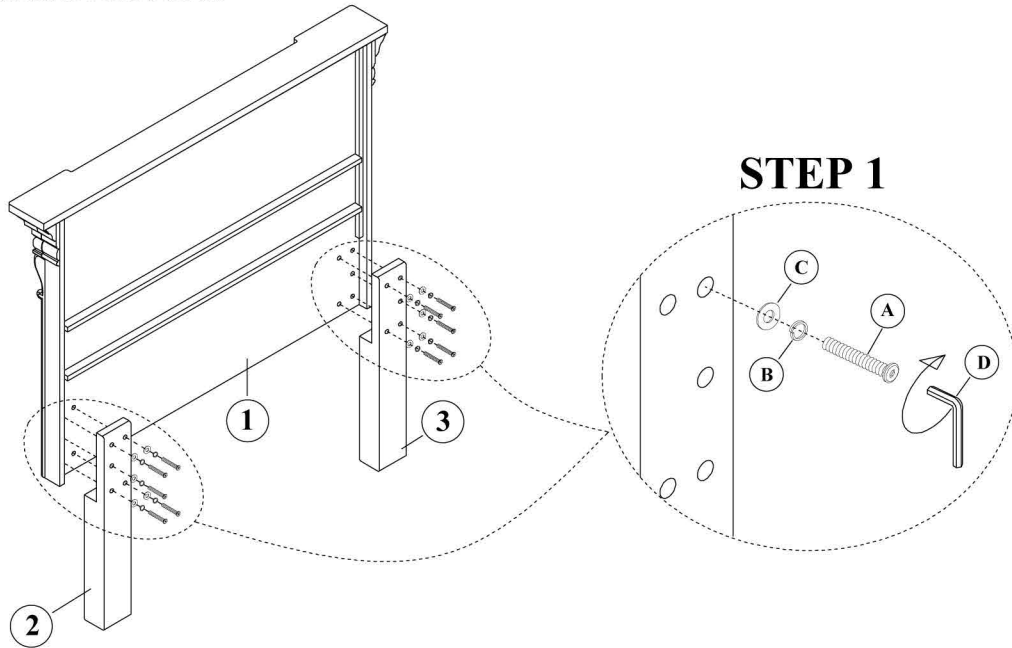

RESIDENTIAL USE ONLY

MADE IN VIET NAM